

SEPTEMBER • 1947

electronics

A MCGRAW-HILL PUBLICATION

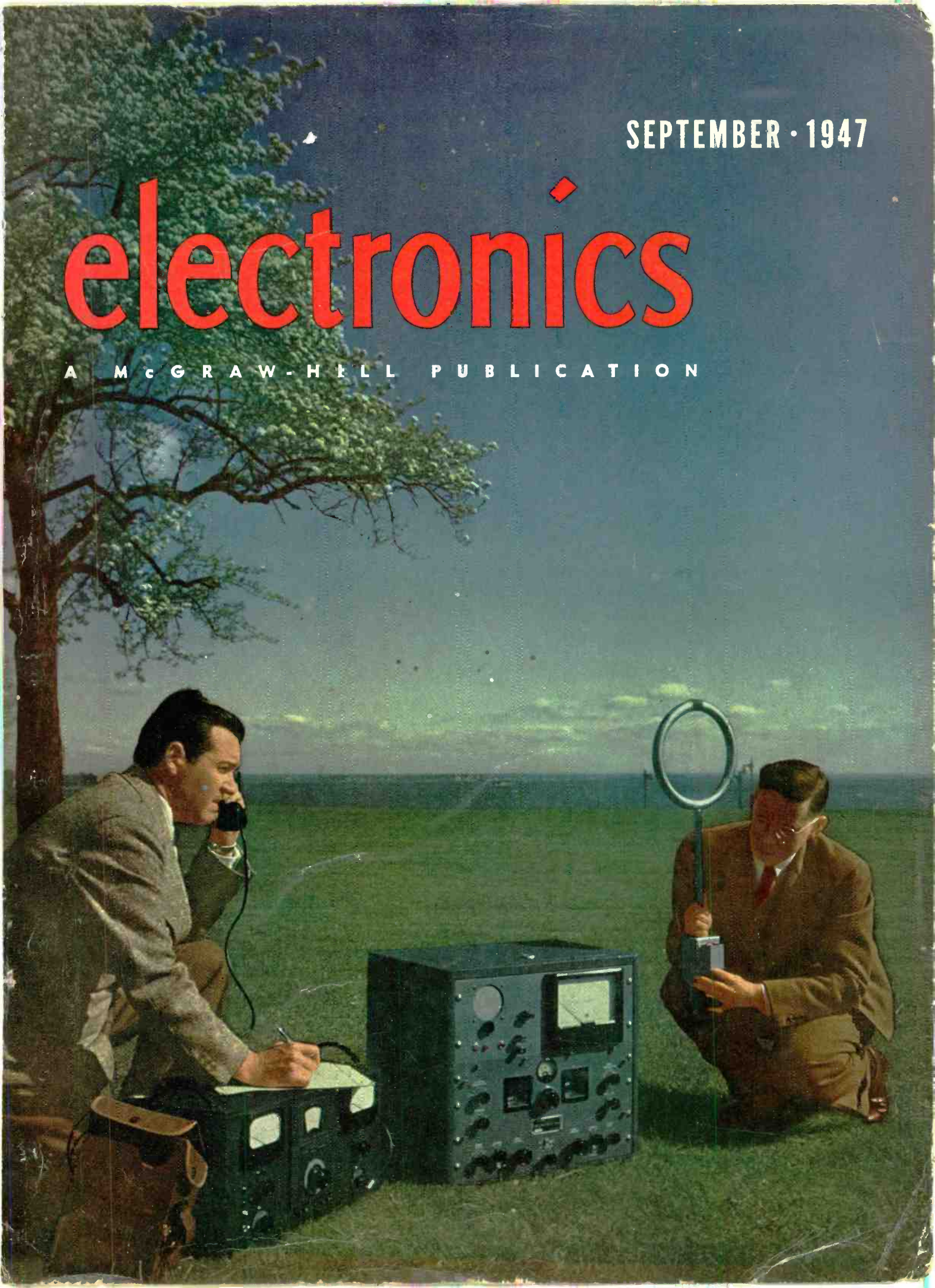

NEW ITEMS AT



New designs and products are in continuous development at the U.T.C. Research Laboratory. While most of these items are specific to customer's unusual requirements, units having general application are added to the New U.T.C. catalogue.

UNIVERSAL RESONANT EQUALIZER

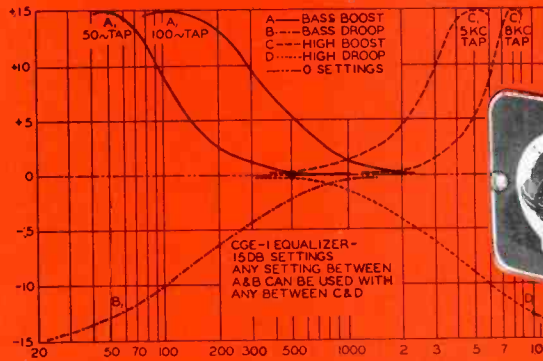

This new U T C unit is the ideal, simple device for any application requiring frequency response correction. Designed to be connected between two triode audio stages or to match a high impedance (5000 to 30000 ohms) source to grid.

The CGE-1 equalizer is not a simple R-C tone control, but employs resonant circuits to permit low or high end equalization without affecting mid-frequencies. With controls in center, no equalization is effected. Moving one control to left increases bass; to right, drops bass. Moving other control to left increases highs; to right drops highs. Controls are independent so that bass may be raised and highs dropped simultaneously, etc. Amount of equalization is continuously adjustable, up to 15 DB, panel calibrated in DB. The insertion loss effected is equal to the combined low frequency and high frequency settings plus 6 DB. Unless existent gain of equipment to which CGE-1 is added is high, an additional audio stage may be required.

This unit comes complete so that controls with etched panel may be mounted on a chassis (2 1/2 inch minimum) or a panel with case containing the electrical elements held by etched panel screws.

CGE-1 Panel Dim. 2 3/8 x 4. Wt. 2 lbs.

List Price \$25.00

PHOTO FLASH TRANSFORMERS

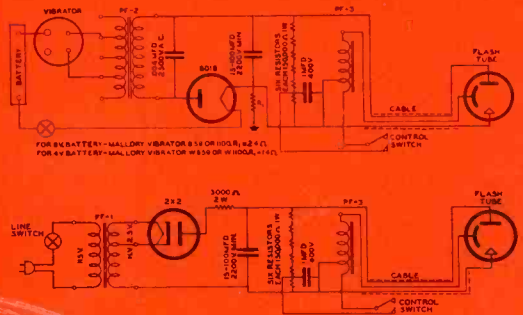

The three basic UTC items described below cover all medium power multiple photo flash applications using trigger type or non trigger type tubes. PF-1 is for AC line units . . . PF-2 is for portable units . . . PF-3 is used for tubes employing trigger electrode.

PF-1 Primary for 115 volts, 50/60 cycles. Secondaries for power supply delivering 2200 volts DC to condenser up to 100 Mfd. (30 Mfd. charges in 8 Sec.) Compound sealed in G-3 case 2 1/8 x 2 3/4 x 2 1/2 inches high. Weight 2 Lbs. List Price . . . \$10.00

PF-2 For portable photoflash service. Primary tapped for 4 volt or 6 volt battery (full wave vibrator). Secondary for power supply delivering 2200 volts DC to condenser up to 60 Mfd. (30 Mfd. charges in 20 Sec. with 6 volts or 28 Sec. with 4 volts). Compound sealed in G-3 case. Weight 2 Lbs. List Price . . . \$10.00

PF-3 Trigger Transformer 15 KV peak List Price . . . \$4.50

For further circuit details, write for sheet #PF.

For Full Listings of UTC Items, Write for Catalogue PS-407

United Transformer Corp.
150 VARICK STREET • NEW YORK 13, N. Y.

EXPORT DIVISION: 13 EAST 40th STREET, NEW YORK 16, N. Y., CABLES: "ARLAB"

electronics

A McGRAW-HILL
PUBLICATION

SEPTEMBER • 1947

FIELD STRENGTH MEASUREMENT	Cover
Determining pattern of transmitting equipment at Sylvania Center, Bayside, N. Y.	
A MEMORY TUBE, by Andrew V. Haeff	80
Cathode-ray tube with dielectric screen retains image as long as necessary	
A NEW TELEVISION PROJECTION SYSTEM, by W. E. Bradley and E. Traub	84
An improved phosphor and a directional viewing screen permit reception at high light levels	
APTITUDE TESTER FOR GARMENT WORKERS, by E. C. Halliday, F. Anderson, and E. O. Garnett	90
Phototube, amplifier, and clock measure total time operator fails to follow wavy line on moving paper strip	
REVERSIBLE-MOTOR CONTROLLER, by J. Gregg Stephenson	93
Simple circuit continuously reverses motor within adjustable limits for automatic control applications	
AUTOMATIC GAIN CONTROL AND LIMITING AMPLIFIER, by W. M. Jurek and J. H. Guenther	94
High average peak level for transmitter, recorder, or p-a system is produced by combination amplifier	
PRECISION BALANCING AT MASS-PRODUCTION SPEED, by Samuel Bousky	98
Electronic balancer enables operator to measure and correct dynamic balance of gyro rotor in two minutes	
R-F INDUCTANCE METER, by Harold A. Wheeler	105
Two r-f oscillators tuned to zero beat give unknown L directly within 1 percent accuracy	
F-M RECEPTION PROBLEMS AND THEIR SOLUTIONS, by N. W. Aram, L. M. Hershey, and M. Hobbs	108
Antenna systems, tuned-circuit stages, and demodulation methods are discussed	
R-F OPERATED REMOTE CONTROL RELAY, by Donald G. Fink	114
Microsensitive relay operates on receiving antenna current and requires no other power	
ADJUSTABLE-BANDWIDTH F-M DISCRIMINATOR, by W. G. Tuller and T. P. Cheatham, Jr.	117
Use of a cathode follower to drive a Foster-Seeley discriminator gives desirable new characteristics	
ANALYSIS OF FULL-WAVE RECTIFIER AND CAPACITIVE-INPUT FILTER, by D. L. Waidelich	120
Simple method permits expressing results in terms of two general parameters	
APPLICATIONS OF MAGNETIC AMPLIFIERS, by W. E. Greene	124
Improved magnetic materials and selenium rectifiers make magnetic amplifiers practical	
MAGNETOSTRICTION RESONANT FREQUENCIES, by R. C. Coile	130
Nomograph gives ultrasonic or sonic frequency of vibrator when rod length and material are known	
CONSULTING ENGINEERS	266
Additions to a list published in ELECTRONICS BUYERS' GUIDE 1947-48	
BUYERS' GUIDE ADDITIONS AND CORRECTIONS	266
Changes and additions to be used as a supplement to the 1947-48 guide	
BUSINESS BRIEFS	74
CROSSTALK	79
TUBES AT WORK	132
ELECTRON ART	136
NEW PRODUCTS	140
NEWS OF THE INDUSTRY	144
NEW BOOKS	258
BACKTALK	264
INDEX TO ADVERTISERS	283

DONALD G. FINK, Editor; **W. W. MacDONALD**, Managing Editor; John Markus, Vin Zeluff, Associate Editors; Frank Rockett, A. A. McKenzie, Assistant Editors; Gladys T. Montgomery, Washington Editor; William P. O'Brien, Make-up Editor; Hal Adams, Editorial Assistant; Dexter Keezer, Director Economics Department; John Chapman, World News Director; Harry Phillips, Art Director; Eleanor Luke, Art Assistant R. S. Quint, Directory Manager

KEITH HENNEY, Consulting Editor

H. W. MATEER, Publisher; **WALLACE B. BLOOD**, Manager; D. H. Miller, H. R. Denmead, Jr., New York; Wm. S. Hodgkinson, New England; F. P. Coyle, R. E. Miller, Philadelphia; C. D. Wardner, Chicago; E. J. Smith, Cleveland; J. W. Otterson, San Francisco; Roy N. Phelan, Los Angeles; Ralph C. Maultsby, Atlanta; Paul West, London, England; J. E. Blackburn, Jr., Director of Circulation

Contents Copyright, 1947, by McGraw-Hill Publishing Company, Inc., All Rights Reserved. McGRAW-HILL PUBLISHING COMPANY INCORPORATED, JAMES H. McGRAW, Founder and Honorary Chairman • PUBLICATION OFFICE 99-129 North Broadway, Albany 1, N. Y., U. S. A. EDITORIAL AND EXECUTIVE OFFICES 330 West 42nd St., New York 18, N. Y., U. S. A.—Member A. B. P. Member A. B. C.

James H. McGraw, Jr., President; Curtis W. McGraw, Senior Vice-President and Treasurer; Nelson Bond, Director of Advertising; Eugene Duffield, Editorial Assistant to the President; Joseph A. Gerardi, Secretary; and J. E. Blackburn, Jr., Vice-President for circulation operations.
ELECTRONICS, September, 1947, Vol. 20; No. 9. Published monthly, with an additional issue in June, price 75c a copy. Directory issue \$2.00. Allow at least ten days for change of address. All communications about subscriptions should be addressed to the Director of Circulation.
Subscription rates—United States and possessions, \$5.00 a year, \$9.00 for two years, \$12.00 for three years. Canada (Canadian funds accepted) \$7.00 a year, \$11.00 for two years, \$14.00 for three years. Pan American countries \$10.00 for one year, \$16.00 for two years, \$20.00 for three years. All other countries \$15.00 for one year, \$30.00 for three years. Please indicate position and company connection on all subscription orders. Entered as Second Class matter August 29, 1936, at Post Office, Albany, New York, under the Act of March 3, 1879. BRANCH OFFICES: 520 North Michigan Avenue, Chicago 11, Ill.; 68 Post Street, San Francisco 4; Aldwych House, Aldwych, London, W.C. 2; Washington, D. C. 4; Philadelphia 3; Cleveland 15; Detroit 26; St. Louis 8; Boston 16; Atlanta 3, Ga.; 621 So. Hope St., Los Angeles 14; 738-9 Oliver Building, Pittsburgh 22.

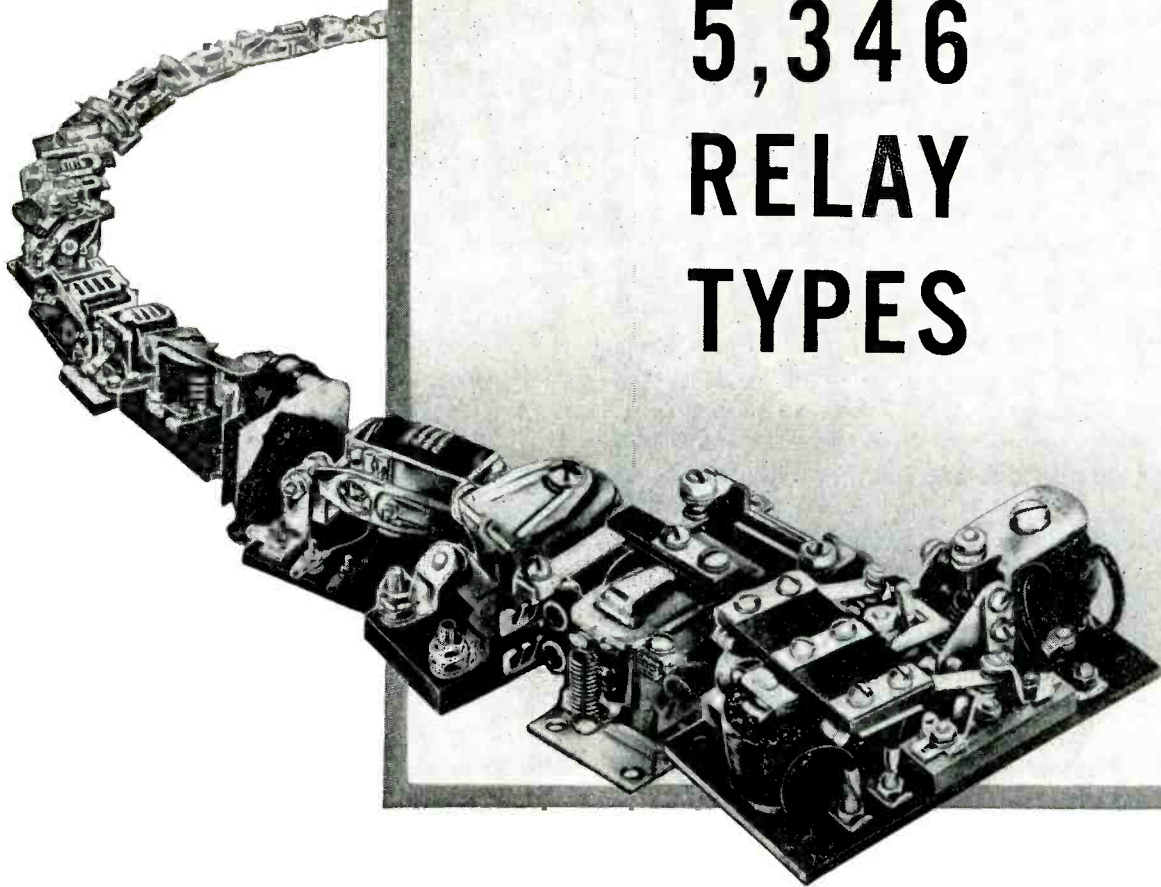

5,346 RELAY TYPES

**Each adaptable to many coil
and contact arrangements to
fit your individual needs.**

*Write for Data Bulletin
on any type*

STRUTHERS-DUNN, INC.—146-150 N. 13th Street, Philadelphia 7, Pa.

STRUTHERS-DUNN

ATLANTA • BALTIMORE • BOSTON • BUFFALO • CHICAGO • CINCINNATI • CLEVELAND • DALLAS
DENVER • DETROIT • HARTFORD • INDIANAPOLIS • LOS ANGELES • MINNEAPOLIS • MONTREAL
NEW YORK • PITTSBURGH • ST. LOUIS • SAN FRANCISCO • SEATTLE • SYRACUSE • TORONTO



...the world's greatest
radio networks



...most efficient
office buildings

The habit of accuracy is so strong in engineers that drawings which are clear and legible are not enough. Creative men want their drawings to look professional, not only in essentials, but in details. K & E has equipment that can help you in both endeavors... drawing instruments and materials so well conceived and precisely made that many engineers and draftsmen regard them as valued partners throughout their professional careers.

For 78 years K & E products have been helping in this way to bridge the gap between thinking and doing, helping to make possible the tools, machines, appliances, construction projects, that mark our civilization. So widely is this true, it is self-evident that every engineering project of any magnitude has been completed with the help of K & E. Could you wish any surer guidance than this in the selection of your own "partners in creating"?

partners in creating

For faster, better lettering you will find a LEROY† Lettering Set a tremendous help. With it you can produce a wide range of lettering styles and symbols with complete

uniformity. Precision lettering need no longer be tedious. For full information write to your nearest K & E Distributor or to Keuffel & Esser Co., Hoboken, N. J. †Reg. U. S. Pat. Off.



Drafting, Reproduction,
Surveying Equipment
and Materials.
Slide Rules,
Measuring Tapes.

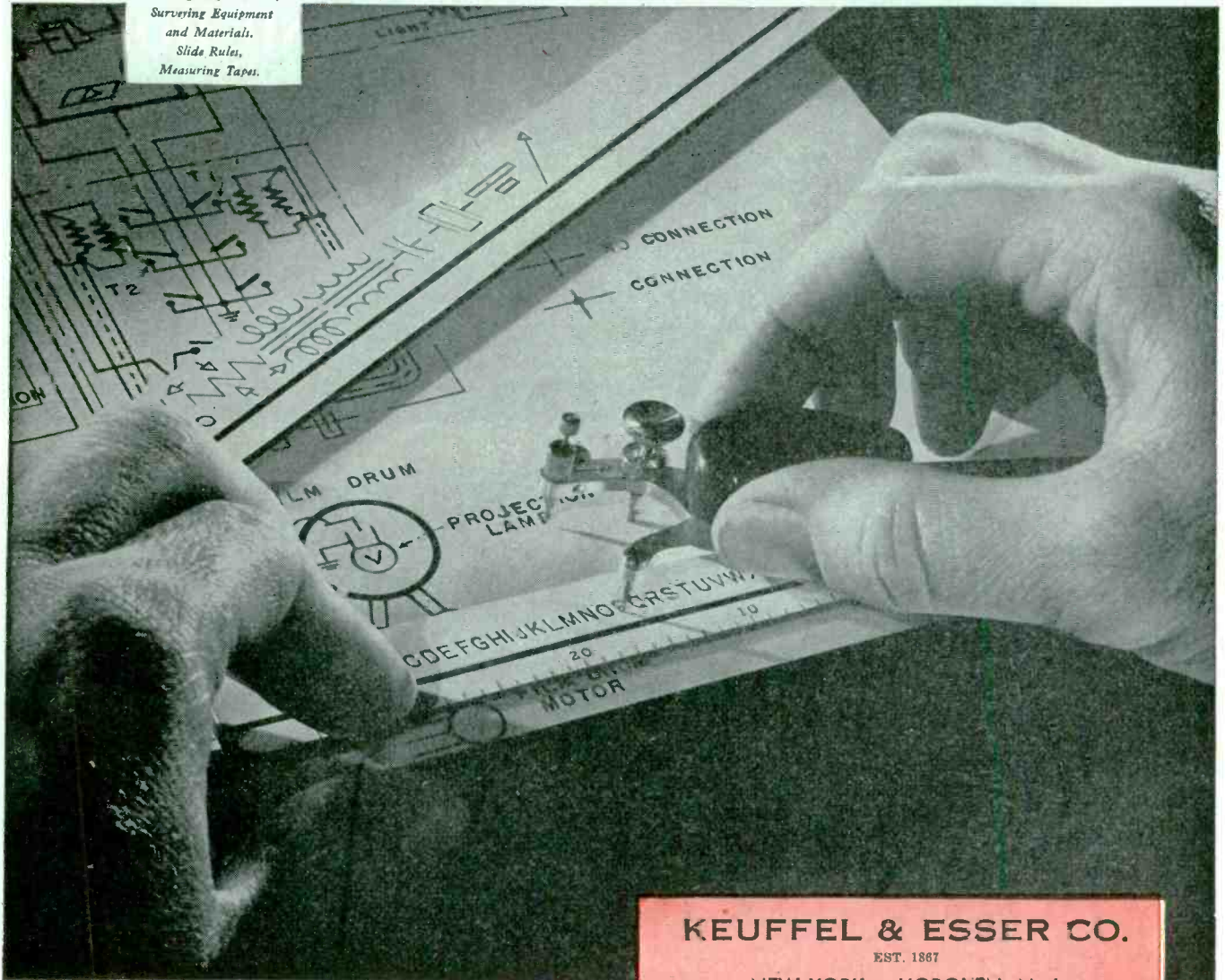

KEUFFEL & ESSER CO.

EST. 1887

NEW YORK • HOBOKEN, N. J.

CHICAGO • ST. LOUIS • DETROIT • SAN FRANCISCO
LOS ANGELES • MONTREAL

Western Electric announces a complete

DIRECT RADIATORS



728B—12" direct radiator.



756A—10" direct radiator



755A—8" direct radiator.

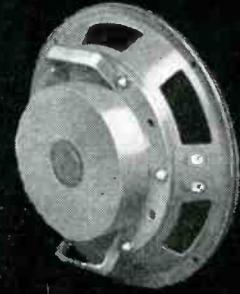

754A—12" direct radiator.
754B (not shown) 12" direct
radiator for outdoor use.

HIGH FREQUENCY RECEIVERS AND HORNS



713B & C—High frequency
receivers

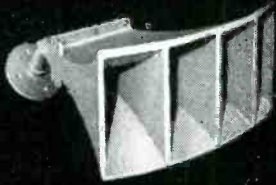

KS-12024—Sectoral high frequency
horn. 50° coverage angle.

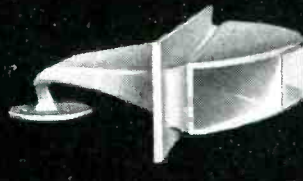

KS-12027—Sectoral high fre-
quency horn. 90° coverage angle.



KS-12025—Sectoral high frequency
horn. 80° coverage angle.

COMBINATIONS . . .

757A—dual unit
system.

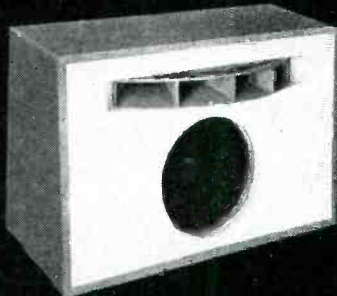

HIGH LEVEL SYSTEMS
for indoor and outdoor use.



Distributed by
Graybar
OFFICES IN 95 PRINCIPAL CITIES

— QUALITY COUNTS —

line of High Quality, wide range loudspeakers

- 1 Sizes and combinations to meet every sound radiation problem . . .
- 2 Power capacities from 8 to 120 watts . . .
- 3 Frequency ranges as wide as 60-15,000 cycles . . .
- 4 All units designed by Bell Telephone Laboratories . . .

IT'S a thrilling, satisfying experience to listen to reproduced sound that is truly *high quality*. The new line of wide range Western Electric loudspeakers was designed to make that experience available to all . . . to provide a complete line of loudspeakers with the ability to reproduce sound of unmatched brilliance and tone.

Whatever your loudspeaker needs, there's a Western Electric loudspeaker to meet them . . . to provide you with sound that's based on a whole new concept of high quality reproduction. Examine the following table to see how your requirements are met, or mail the coupon below for literature describing this new line of equipment.

HERE'S HOW YOUR QUALITY REQUIREMENTS ARE MET

TYPE	POWER HANDLING CAPACITY	FREQUENCY RESPONSE (cycles)	INPUT IMPEDANCE	COVERAGE ANGLE	EFFICIENCY (Sound Level of 30' on Axis)	WEIGHT	SPEAKER DIMENSIONS	ENCLOSURE REQUIRED	RECOMMENDED CABINET DIMENSIONS (Sloping front)
755A 8" direct radiator	8 watts	70-13,000	4 ohms	70°	81.5 db above 10 ⁻¹⁶ watts per sq. cm. at 8 watts input	Speaker—4½ lbs.	Dia.—8½" Depth—3½" Baffle Hole Dia.—7"	2 cu. ft.	Width—16" Height—21" Top Depth—9½" Bottom Depth—12"
756A 10" direct radiator	20 watts	65-10,000	4 ohms	60°	89.5 db above 10 ⁻¹⁶ watts per sq. cm. at 20 watts input	Speaker—10 lbs.	Dia.—10½" Depth—3½" Baffle Hole Dia.—8½"/16"	2½ cu. ft.	Width—19" Height—22" Top Depth—8½" Bottom Depth—11½"/16"
728B 12" direct radiator	30 watts	60-10,000	4 ohms	50°	93.5 db above 10 ⁻¹⁶ watts per sq. cm. at 30 watts input	Speaker—17 lbs.	Dia.—12½"/32" Depth—3½"/12" Baffle Hole Dia.—11"	3 cu. ft.	Width—21" Height—23½" Top Depth—9½" Bottom Depth—12½"
754A 12" direct radiator	15 watts	60-10,000	4 ohms	50°	94 db above 10 ⁻¹⁶ watts per sq. cm. at 15 watts input	Speaker—17 lbs.	Dia.—12½"/32" Depth—3½" Baffle Hole Dia.—11"	3 cu. ft.	—
754B 12" direct radiator (outdoor type)	50 watts	60-10,000	4 ohms	50°	94 db above 10 ⁻¹⁶ watts per sq. cm. at 50 watts input	Speaker—17 lbs.	Dia.—12½"/32" Depth—3½" Baffle Hole Dia.—11"	2½ cu. ft.	—
757A 2 unit system	30 watts	60-15,000	4 ohms	90°	93 db above 10 ⁻¹⁶ watts per sq. cm. at 30 watts input	82 lbs. including cabinet	Composed of 1-728B low frequency unit and 1-713C high frequency receiver with KS-12027 horn	Enclosure furnished with system	Width—30½" Height—20" Top Depth—11¼" Bottom Depth—13¼"
713B high frequency receiver	25 watts	With horns KS-12024-5-7 800-15,000	4 ohms	(See specifications for horns)	With KS-12024—100 db KS-12025—98 db KS-12027—97 db	8 lbs.	Dia.—4½"/16" Depth—4½"	—	—
713C high frequency receiver	25 watts	With horns KS-12024-5-7 800-15,000	4 ohms	(See specifications for horns)	With KS-12024—97 db KS-12025—95 db KS-12027—94 db	8 lbs.	Dia.—4½"/16" Depth—4½"	—	—
KS-12027 high frequency horn	—	With 713C Receiver 800-15,000	—	90° horizontal 90° vertical	—	10 lbs.	Length—13½" Width—19½"/16" Height—2½"/16"	—	—
KS-12024 high frequency horn	—	With 713C Receiver 800-15,000	—	50° horizontal 40° vertical	—	7 lbs.	Length—16½" Width—13½"/16" Height—6½"	—	—
KS-12025 high frequency horn	—	With 713C Receiver 800-15,000	—	80° horizontal 40° vertical	—	12 lbs.	Length—19" Width—23½"/32" Height—6½"	—	—
High Level Speaker Systems (For indoor or outdoor use)	Range from 30 to 120 watts in single units	60-10,000	Depends on Components	Range from 50° to 100°	Depends on Components	Range from 140—380 lbs.	Systems composed of 754A or 754B low frequency units, 713B high frequency receivers, and KS-12024 or KS-12025 horns	Enclosures furnished with systems. Include low frequency horns	Range from 50" x 26" x 48" to 78" x 52" x 48"

SEND FOR COMPLETE INFORMATION →

Graybar Electric Co.
420 Lexington Ave., New York 17, N. Y.
Gentlemen: Please send me literature describing the new line of Western Electric loudspeakers.

Name _____
Company _____
Address _____

Where SPACE and
PERFORMANCE are Vital
DUMONT OFFERS

The
TINYMITE

SMALLEST PAPER
CAPACITOR . . .
yet 100%
MOISTUREPROOF

TYPE
P5N

600V

600V

TYPE
P4N

CLOCK
RADIO

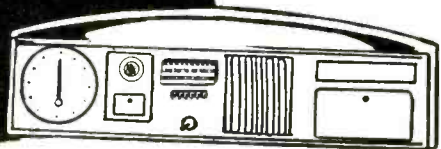

AUTO RADIOS

FEATURES

1. Bakelite Resinoid Ends. Lead wire cannot pull out, even under hot conditions.
2. Non-Inductive.
3. Excellent Temperature Coefficient.
4. Very high leakage Resistance.
5. Fine Power-Factor.
6. Range from 20 MMFD to .25 MFD.
From 150 volts to 600 volts.
7. Extremely moisture proof.
8. Heat-proof.

PAT.
PENDING

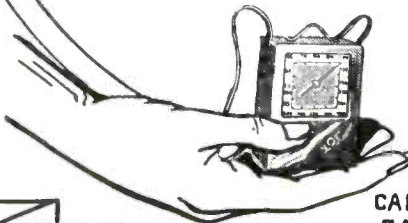

CARRYING
RADIOS



HEARING
AIDS

**DUMONT
ELECTRIC CORP.**

MFR'S OF
CAPACITORS FOR EVERY REQUIREMENT
34 HUBERT STREET NEW YORK, N. Y.

SAMPLES AND PRICE LIST ON REQUEST

*Meet sudden change-orders without
tying up Press Production*

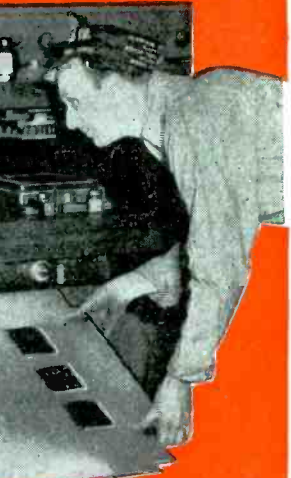
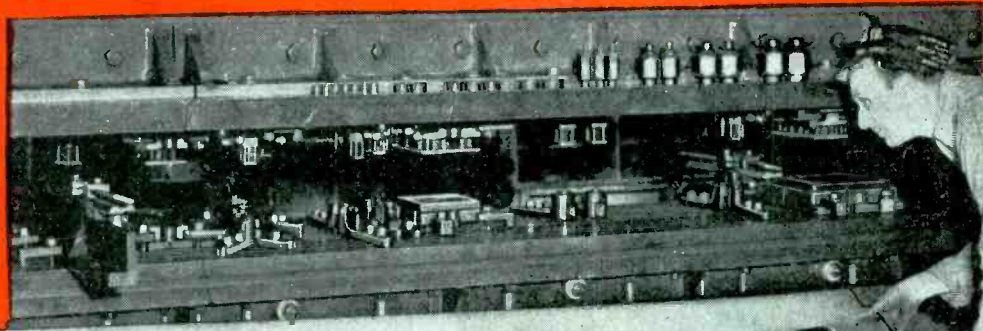

WHISTLER ADJUSTABLE PERFORATING DIES

**quickly and easily
rearranged**



Change-orders from the engineering department usually cause plenty of headaches in production... particularly where die piercing operations are involved.

But... if you're using Whistler Adjustable Dies, there is no lost time—no waiting—no extra die expense. The same dies are easy to rearrange to the new design. Add units from stock, or delete sizes and shapes no longer required. Arrange the new set-up right on the press.

Consider the savings in production time alone. Then think how continued re-use of the same dies in subsequent jobs writes off first cost.

Whistler Dies can be used in practically any press. All parts are interchangeable. Precision is assured on long or short runs. Closer centers permit fewer press operations.

Deliveries are quick... little or no waiting. Standard round punches and dies up to 3" are available from stock. Ovals, squares, rectangles and special shapes can be made up in a few days. Write for the Whistler Catalogs today and get all the facts.



See Us at Booth 301, National Metals Show, Chicago, October 18th to 24th

S. B. WHISTLER & SONS, INC.
746 MILITARY ROAD BUFFALO 17, NEW YORK

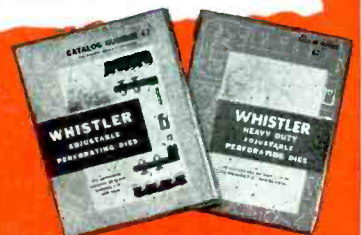

You're Looking at the Finest—



—a complete Hammarlund station

An HQ-129-X receiver, the choice of thousands of well-satisfied owners. And a Four-20 Transmitter with its companion Four-11 Modulator, a combination that is getting out all over the world. R9+ reports from China, Argen-

tina, Hawaii, Australia . . . coming in to the many amateurs now using the Four-20 on the air.

You, too, can be in this picture . . . Equip yourself with a complete Hammarlund station.

There will be no new Hammarlund receiver in the price range of the HQ-129-X until the spring of 1948 at the earliest.



HAMMARLUND

THE HAMMARLUND MFG. CO., INC., 460 W. 34TH ST., NEW YORK 1, N.Y.
MANUFACTURERS OF PRECISION COMMUNICATIONS EQUIPMENT



Write for Descriptive Booklet

the **LITTLE**
differences

We know that our brazing techniques are as good as can be . . . but we also know that you can't always be sure of perfect heat conduction through the brazed metals.

For that reason, we've developed a method of cutting our radiators for the 8002-R out of a solid chunk of metal; giving us a perfect heat conducting path between the core and its fins. This prevents "spot heating" of the tube's copper anode.

It's quite a trick to slice those cooling fins so that they radiate equally from the center and do not vary in thickness. But we mastered it!

And we have hundreds of other "little differences" in the design and construction of the many, many types of transmitting, rectifying and special purpose tubes that comprise the extensive Amperex line.

It's these little differences that combine to make the **BIG** difference when you

re-tube with Amperex

make the **BIG**
difference

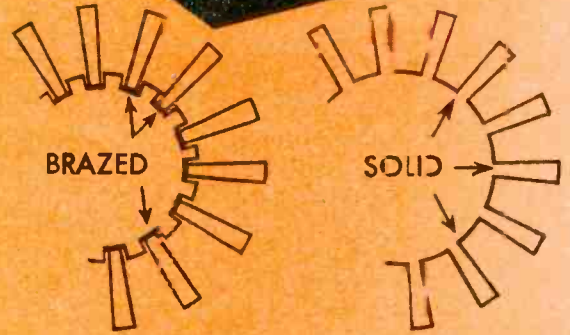

**AMPEREX
ELECTRONIC
CORPORATION**



25 WASHINGTON STREET, BROOKLYN 1, N. Y.
In Canada and Newfoundland: Rogers Majestic Limited
11-19 Brentcliffe Road, Leaside, Toronto, Ontario, Canada

THE HIGH STANDARD OF YOUR NAME
IS ASSURED WHEN YOU BUILD IN

Potter & Brumfield Relays

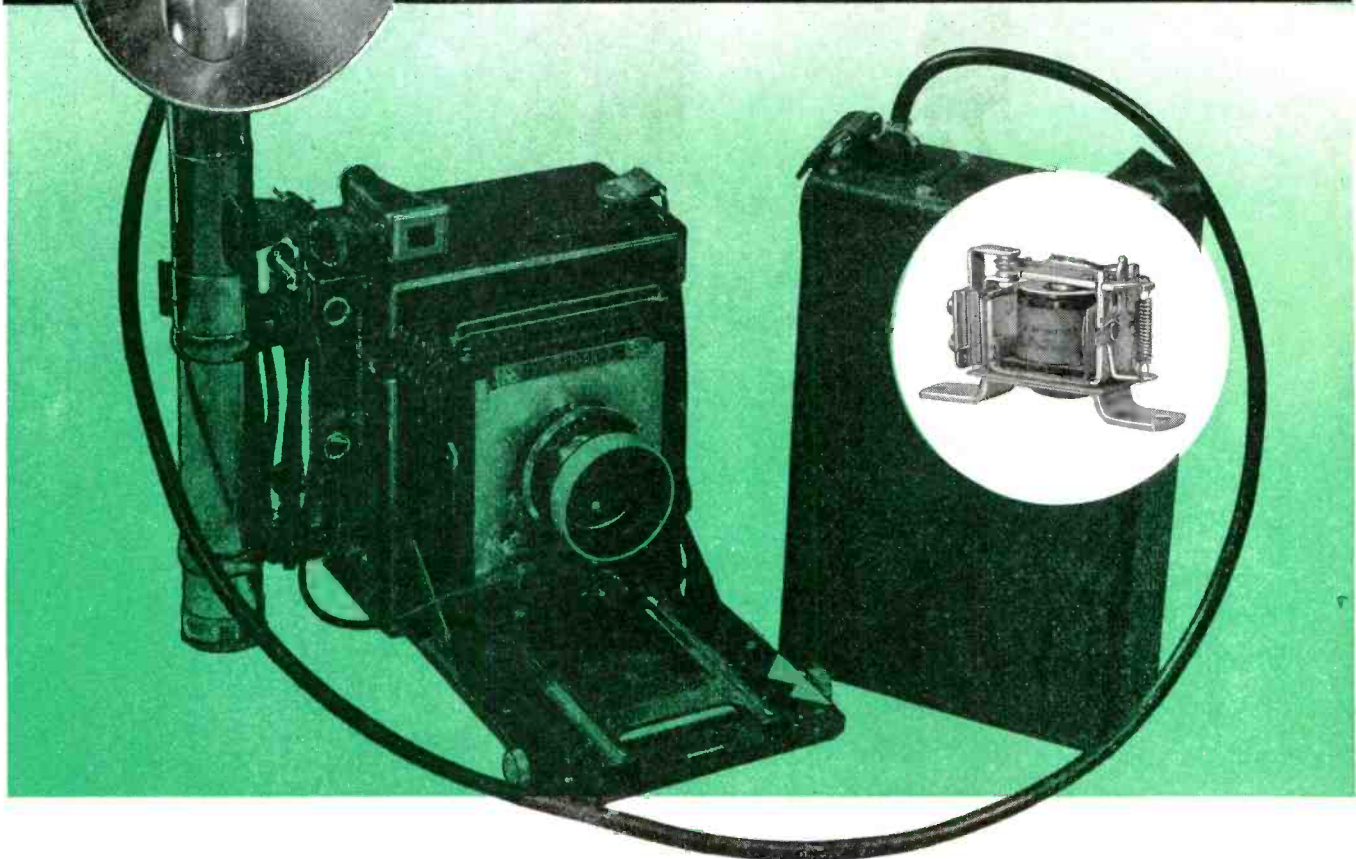

● **For Uniform Repetitive Accuracy In Transit Time And For High Surge Current, The Triumph Speed Flash Unit Depends On A Specially Designed Potter & Brumfield Relay.**

Here is another example of Potter & Brumfield performance engineering to meet inflexible requirements upon which the satisfactory operation of the end product is dependent.

This product is a high voltage actuated xenon gas ultra-high speed photo-flashlight unit. For acceptable performance, the relay must be even more uniformly repetitive than the precision shutter of a fine camera. When energized by a manual switch on the "flash gun" the relay discharges 2,500 volts from a saturated condenser in 1/10,000 second in synchronization with the shutter of the camera (approximately 48.6 watt seconds energy). Unfailingly positive contact is vital to

synchronization and uniformity of color temperature. Contacts developed specially for this application carry this high surge current without sticking, burning or pitting. This relay has capably proven its ability in the field to take wide ranges of temperature, humidity and shock, in its stride. It is being supplied well within the customer's cost allowance.

POTTER & BRUMFIELD engineers are always available to design special relays to the performance requirements of your new or unusual applications—for low production cost. Your inquiries are solicited and assured of prompt attention.

POTTER & BRUMFIELD also offers a complete line of stock relays in power, midget, latching, leaf, plate-circuit, telephone, shock-proof and motor-starting types. Complete data on these standard assemblies is available in the comprehensive, illustrated P&B catalog. Write for your copy.

YOUR LOCAL ELECTRONICS PARTS DISTRIBUTOR STOCKS STANDARD P&B RELAYS



POTTER & BRUMFIELD SALES COMPANY

549 W. WASHINGTON BLVD., CHICAGO 6, ILLINOIS • FACTORY AT PRINCETON, INDIANA
Export: 2020 Engineering Building, Chicago 5, Illinois

Erase PROBLEMS like these-

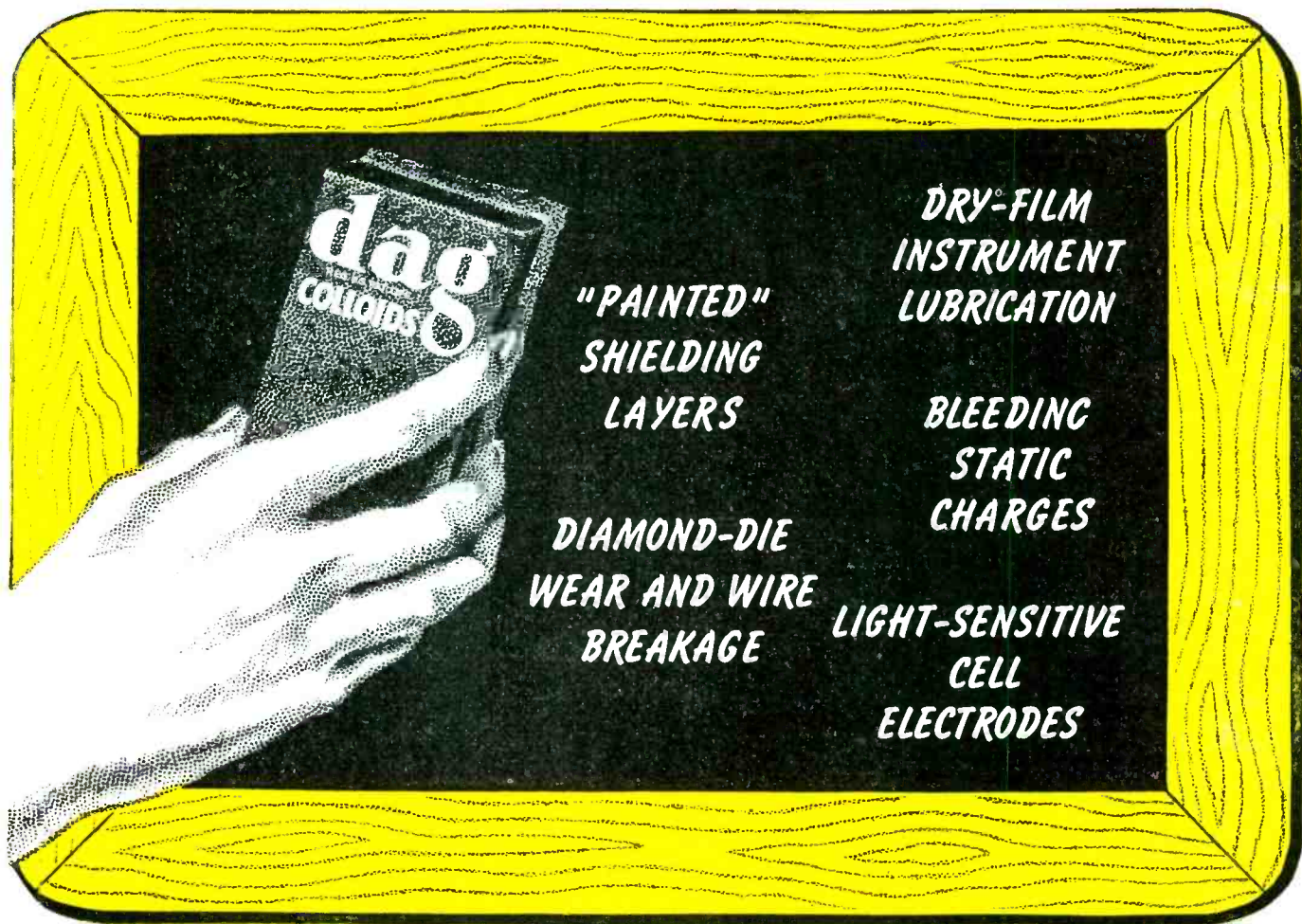

"PAINTED" SHIELDING LAYERS

DIAMOND-DIE WEAR AND WIRE BREAKAGE

DRY-FILM INSTRUMENT LUBRICATION

BLEEDING STATIC CHARGES

LIGHT-SENSITIVE CELL ELECTRODES

You can easily eliminate these annoying and costly problems in your industry if you will call on "dag" for help.

Many years of experience in the development of new uses for "dag" colloidal graphite have given Acheson Colloids Corporation the knowledge and skill to help you solve these and many other troublesome problems. There are 18 different dispersions of "dag" colloidal graphite, one or more of which

will surely be useful to you. The properties of "dag" colloidal graphite are perfectly suited for forming electrically conductive films, for coating and impregnation, for conduction of heat and electricity, for resistance to high temperature, and for many other purposes.

Why not send in the coupon below for these fact-filled booklets and discover for yourself what versatile "dag" colloidal graphite can do for you?

ACHESON COLLOIDS CORPORATION, Port Huron, Michigan

This new literature on "dag" colloidal graphite is yours for the asking:

- 460** A data and reference booklet regarding "dag" colloidal graphite dispersions and their applications. 16 pages profusely illustrated.
- 421** Facts about "dag" colloidal graphite for ASSEMBLING AND RUNNING-IN ENGINES AND MACHINERY.
- 422** Facts about "dag" colloidal graphite as a PARTING COMPOUND.
- 423** Facts about "dag" colloidal graphite as a HIGH TEMPERATURE LUBRICANT.
- 431** Facts about "dag" colloidal graphite for IMPREGNATION AND SURFACE COATINGS.
- 432** Facts about "dag" colloidal graphite in the FIELD OF ELECTRONICS.

ACHESON COLLOIDS CORPORATION
PORT HURON, MICHIGAN DEPT. J-5

JMLcoA-C-1

Please send me without obligation, a copy of each of the bulletins checked:

NAME _____
 POSITION _____
 FIRM _____
 ADDRESS _____
 ZONE No. _____ STATE _____
 OUR PRESENT OIL SUPPLIER IS _____

(Lubricants containing "dag" colloidal graphite are available from major oil companies.)

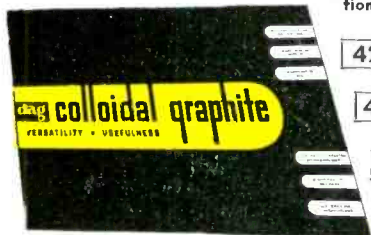

PROFESSIONAL PERFORMANCE — that keeps the original sound alive!

**Stop
WOW!**



—with a positive drive at 33.3 and 78 rpm

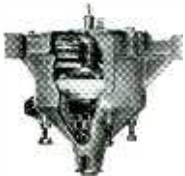

Remember this: When a listener becomes dissatisfied with the quality of your programs, he simply twists a dial. And in doing so, he also tunes out his pocketbook. So why jeopardize what is probably your best source of revenue—*your recorded programs!*

Professional recording and playback should be, and can be, 'WOW'-free. How? With the time-tested Fairchild direct-from-the-center turntable drive, shown above. It eliminates all variations in turntable speed. Evenness of speed is obtained by a carefully calculated loading of the drive mechanism to keep the motor pulling constantly; by careful precision control of all drive alignments that might cause intermittent grab and release; by carefully maintained .0002" tolerances in all critical moving parts.

Further aid to 'WOW'-free performance is provided by a perfectly balanced turntable with extra weight in the rim and a turntable clutch that permits smooth starting, stopping and shifting from 33.3 to 78 rpm in operation.

Fairchild's 'WOW'-free performance is available on professional Transcription Turntables, Studio Recorders and Portable Recorders. For complete information—and prompt delivery—address: 88-06 Van Wyck Blvd., Jamaica 1, New York.



Transcription Turntables
Studio Recorders
Magnetic Cutterheads
Portable Recorders
Lateral Dynamic Pickups
Unitized Amplifier Systems



Fairchild

CAMERA

AND INSTRUMENT CORPORATION

SOUND EQUIPMENT



This Single Instrument...!

**SAVES EXPENSIVE ENGINEERING TIME, INCREASES
ACCURACY, ELIMINATES EXTRA EQUIPMENT**

Vacuum-tube voltmeter:
standardized voltages,
150v to 50mv

Vacuum-tube voltmeter
measures any external
voltage

Frequency range, 20 cps to
20 kc. No zero-setting
required



.110 db attenuation of output
signal, 1 db steps

5 watts output; less than 1%
distortion

50, 200, 600, 5000 ohm
output impedance



205AG AUDIO SIGNAL GENERATOR

Here's the compact precision instrument that gives you the measuring capacities and scope of 6 individual instruments, yet occupies bench space of but one! This famous *-hp-* 205AG provides typical *-hp-* accuracy and ease of operation (no zero-set, for example) for almost any test job from 20 cps to 20 kc. It delivers 5 watts power with less than 1.0% distortion at the commonly-used impedance levels of 50, 200, 600, and 5000 ohms. Meter calibration, in volts and db, is based on a 600 ohm level, to conform with RMA standards. The instrument's output voltage ranges from 150 volts to 50 microvolts. Where input vacuum tube voltmeter is not required, the *-hp-* 205A is available. This instrument is identical in other characteristics to the 205AG. And, for supersonic measurements, the *-hp-* 205AH is provided. This instrument covers a frequency range of 1 kc to 100 kc and is similar to the *-hp-* 205A. For full details of any of these rugged, long-lasting *-hp-* instruments, write or wire today.

Hewlett-Packard Company • 1452A Page Mill Road • Palo Alto, Calif.

MAKE THESE MEASUREMENTS WITHOUT EXTRA APPARATUS

Frequency Response

•
Audio Gain

•
Filter Transmission
Characteristics

•
Audio Frequencies

•
Voltage Measurements

•
Speaker Tests (No
amplifiers needed)

or
Drive Electro-Mechanical
Equipment

1452

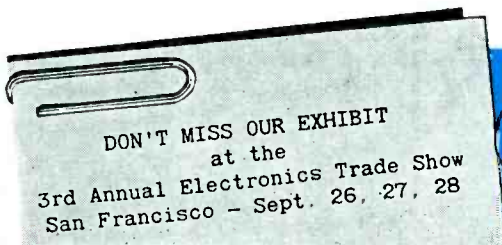

hp laboratory instruments
FOR SPEED AND ACCURACY

THESE *-hp-* REPRESENTATIVES ARE AT YOUR SERVICE

CHICAGO 6, ILL.: Alfred Crossley, 549 W. Randolph St., State 7444 • HOLLYWOOD 46, CALIF.: Norman B. Neely Enterprises, 7422 Melrose Ave., Whitney 1147
HIGH POINT, N. C.: Bivins & Caldwell, 134 W. Commerce St., High Point 3672 • NEW YORK 7, N. Y.: Burlingame Associates Ltd., 11 Park Place, Worth 2-2171
DENVER 10, COLO.: Ronald G. Bowen, 1886 S. Humboldt St., Spruce 9368 • TORONTO 1, CANADA: Atlas Radio Corp. Ltd., 560 King St. West, Waverley 4761
DALLAS 5, TEXAS: Earl W. Lipscomb, 4433 Stanford Street, Logan 6-5097

Centralab reports to

SEPTEMBER 1947

Many possible mechanical variations of popular "M" Radiohm serve to keep down inventory, step-up production.

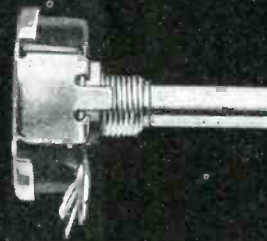

1. Single "M" Radiohm with solid shaft.

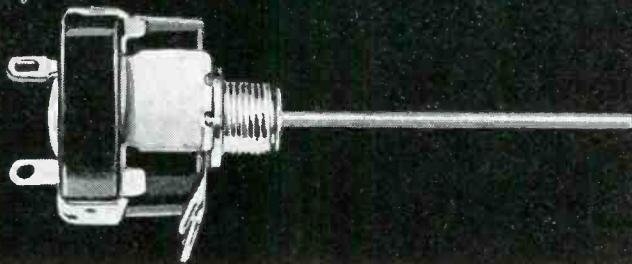

2. Single Radiohm, line switch and detachable shaft.

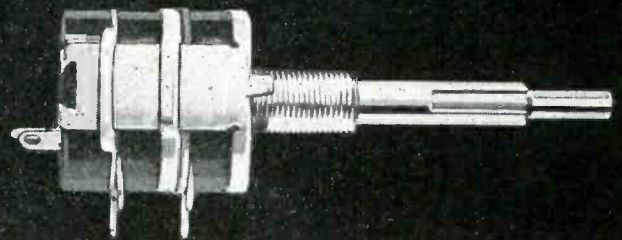

3. Twin Radiohm, line switch and dual shaft.

I Take a look at the many variations you can have from Centralab's single, model "M" Radiohm. Can be "twinned" or "tripled", with or without line switch. Your choice of solid, detachable and dual shafts gives you new versatility, maximum convenience

... helps keep down inventory, step-up production of electronic equipment. Guaranteed minimum life test of 10,000 cycles (control resistance). Available with shaft and bushing lengths to meet your needs. Send for bulletin 697-A.



2 Like all Centralab Radiohms, the model "M" combines the finest in engineering and research... 100% tested and inspected.

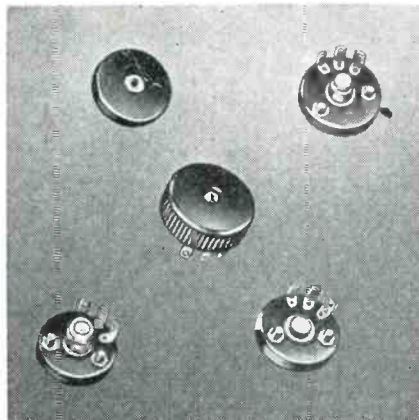

3 Here's Centralab's newest control for miniature receivers, amplifiers. No bigger than a dime, high quality performance is assured.

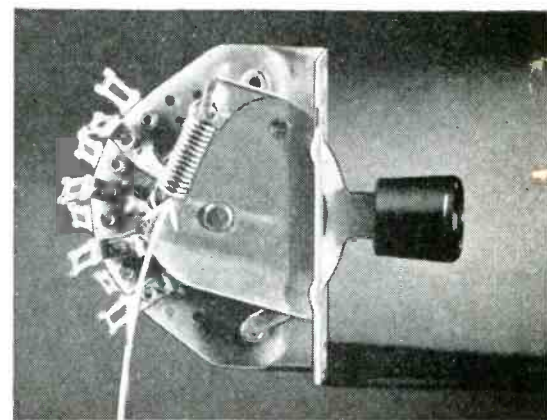

4 CRL's revolutionary new *Lever Switch* features exclusive coil spring design with cam and roller, guaranteed minimum life of 25,000 cycles. Write for bulletin 970.

Electronic Industry

Cutaway view shows integral ceramic construction

Solid brass terminals, soldered directly to electrodes.

Metallic silver electrodes fired directly to high dielectric constant Ceramic-X.

Low loss, mineral filled phenolic resin.

Three terminal types for strong, fast connections.

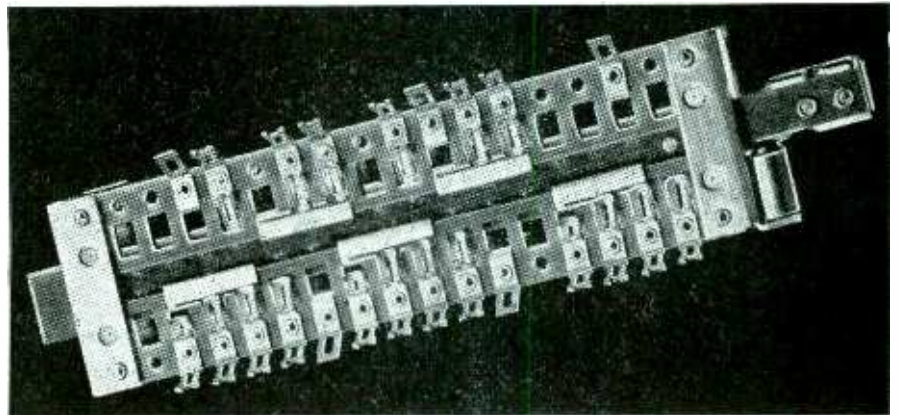
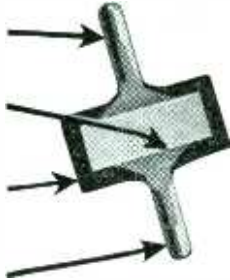

5 CRL *Hi-Vo-Kaps* combine high voltage and small size for television applications. For use as filter and by-pass capacitors in video amplifiers. Write for bul. 946.

6 Centralab's new *Slide Switch* promises improved AM and FM performance! Flat horizontal design saves valuable space, allows short leads, convenient location to coils, reduced lead inductances for increased efficiency in low and high frequencies. Designed for maximum reliability and long service life. Write for bulletin 953.

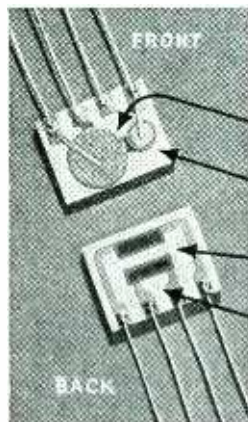

NOW SEE HOW THIS REPLACES THIS

C₁—Coupling Capacitor, .01 mfd. is standard

C₂—Plate R.F. By-Pass Capacitor, 250 mmf. \pm 20% is standard

R₁—Plate Load Resistor, 250,000 Ohms \pm 20% 1/5 watt is standard

R₂—Grid Resistor, 500,000 Ohms \pm 20% 1/5 watt is standard

Other Values Available

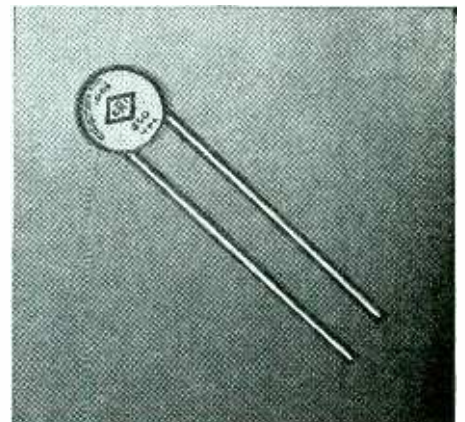
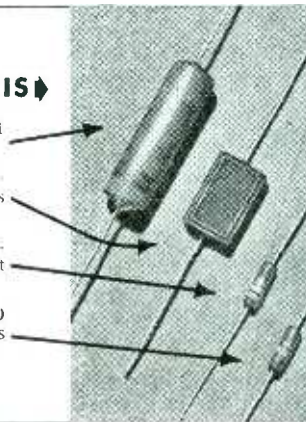

7 First commercial application of the "printed circuit", CRL's new *Couplate* offers a complete interstage coupling circuit consisting of an integral assembly of *Hi-Kap* capacitors and resistors closely bonded to a steatite ceramic plate, and mutually connected by metallic silver paths "printed" on the base plate.

8 CRL *Hi-Kaps*, miniature ceramic disc capacitors, offer utmost reliability in small physical size and low mass weight. Write for bulletin 933.

Look to Centralab in 1947! *First in component research that means lower costs for electronic industry. If you're planning new equipment, let Centralab's sales and engineering service work with you. Get in touch with Centralab!*

Centralab

DIVISION OF GLOBE-UNION INC., MILWAUKEE, WIS.

SANGAMO

SANGAMO *Type G* **CAPACITORS**

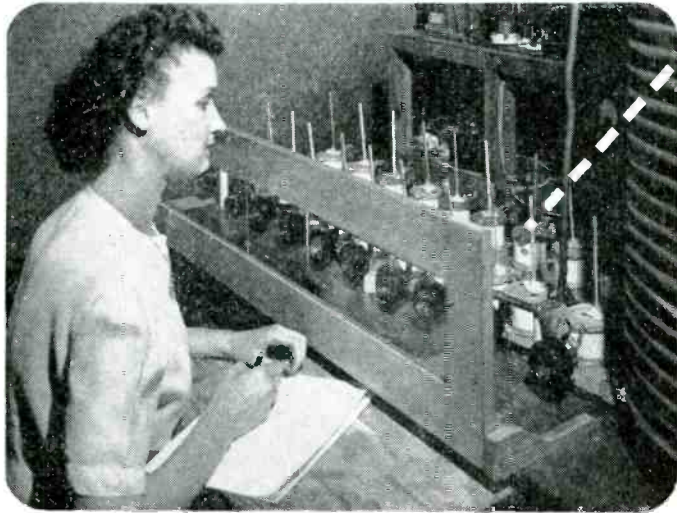

Correctly Designed Precision-Built R-F Tested...

Checking Type G capacitors for current-carrying ability on high frequency.

Sangamo Type G Mica Capacitors are built to rigid Sangamo specifications, of the best materials obtainable and with the most precise production methods. They are correctly engineered to assure high current-carrying ability, to hold losses to a minimum, and to provide maximum safety. Every Type G capacitor is individually tested for temperature rise at maximum R. F. current in order to insure the high standard of Sangamo Quality inherent in all Sangamo Capacitors.

Designed for service where highest voltage and R. F. current ratings are required, such as in commercial transmitting, aircraft control, induction heating and X-ray equipment applications;

Sangamo Type G Capacitors can provide the answer to your post-war electronic capacitor needs.

Detailed information and current ratings of these capacitors will be supplied upon request.

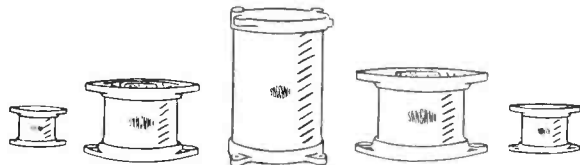

SC476

SANGAMO
ELECTRIC COMPANY
SPRINGFIELD • ILLINOIS

Eliminate costly hand assembly

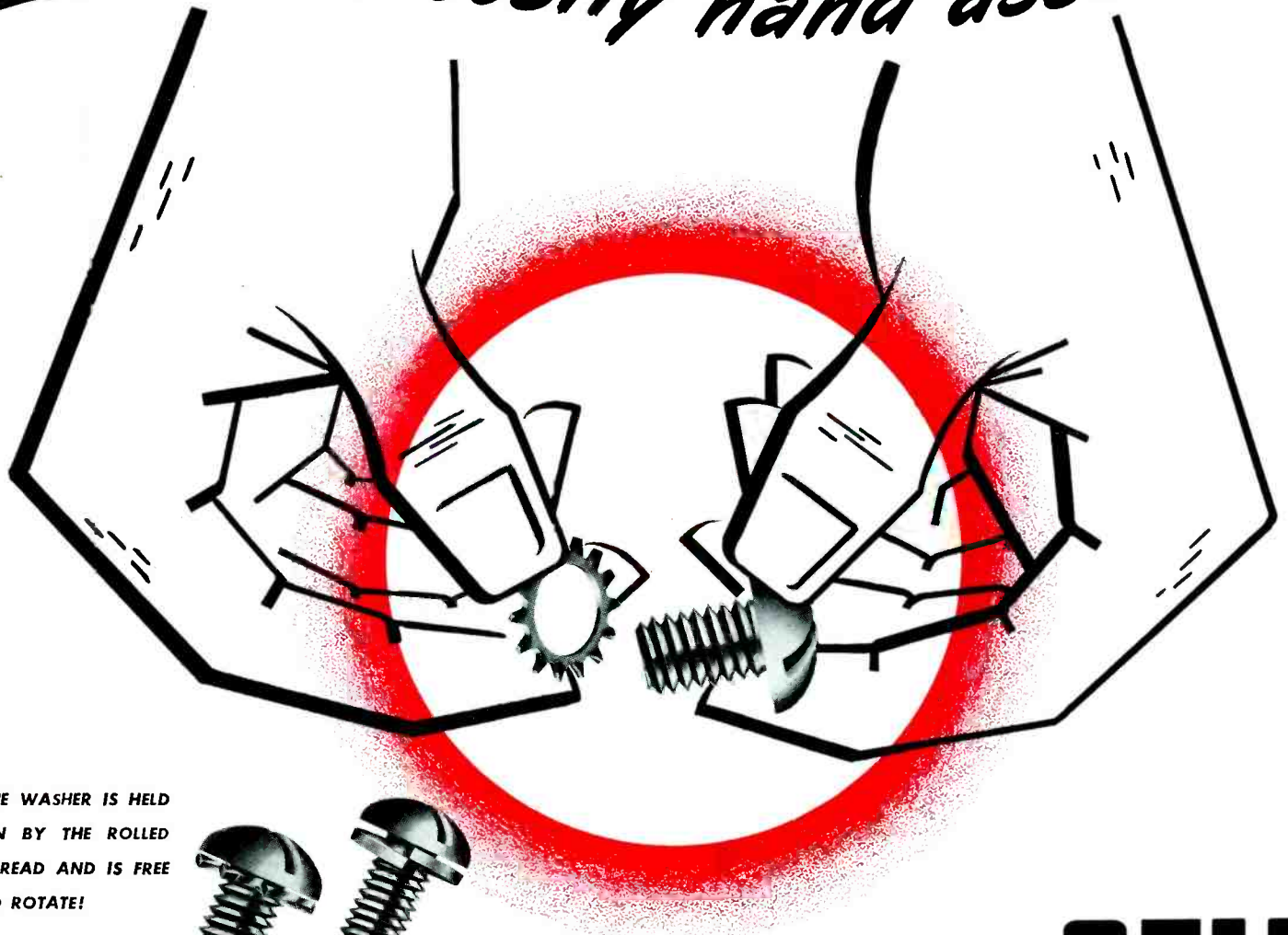

THE WASHER IS HELD
ON BY THE ROLLED
THREAD AND IS FREE
TO ROTATE!



save money with

SEMS

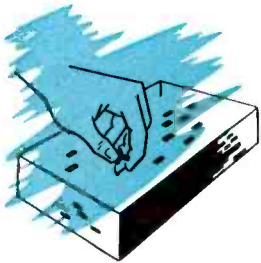

TWO PARTS PRE-ASSEMBLED; ONLY ONE
UNIT TO ORDER, STOCK AND HANDLE.

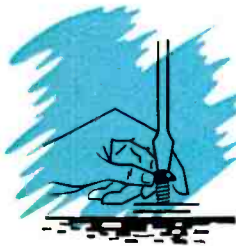

DRIVING IS EASIER, FASTER. SEMS ARE
PERFECT FOR HARD TO REACH PLACES.



NO DROPPED OR WASTED WASHERS.
ASSEMBLY MOVES SMOOTHLY.

ANY OF THESE MANUFACTURERS WILL SEND YOU THE SEMS DATA BOOK, FREE!

Eaton Manufacturing Co.
Reliance Division
Massillon, Ohio

The Lamson & Sessions Co.
Cleveland, Ohio

National Lock Co.
Rockford, Illinois

The National Screw & Mfg. Co.
Cleveland, Ohio

New England Screw Co.
Keene, N. H.

Pheoll Manufacturing Co.
Chicago, Illinois

Russell, Burdsall & Ward
Bolt & Nut Co.
Port Chester, N. Y.

Scovill Manufacturing Co.
Waterville Division
Waterville, Conn.

Shakeproof Inc.

Division of Illinois Tool Works
Chicago, Illinois

Steel Co. of Canada, Ltd.
Hamilton, Ont., Can.

Stronghold
Screw Products Inc.
Chicago, Ill.

American Screw Co.
Providence, R. I.

Central Screw Co.
Chicago, Ill.

Chandler Products Corp.
Cleveland, Ohio

Continental Screw Co.
New Bedford, Mass.

Corbin Screw Division
The American Hardware Corp.
New Britain, Conn.

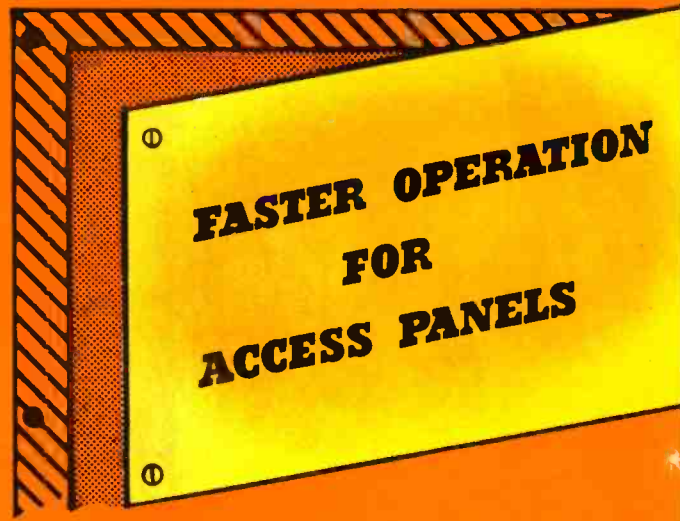
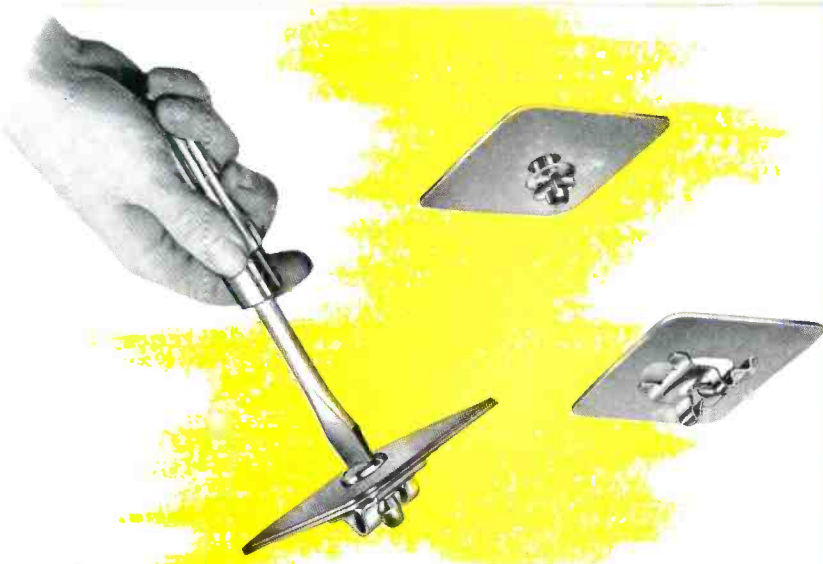

1/4 TURN OPENS OR LOCKS
SHAKEPROOF
Q-FASTENERS

Shakeproof Q-Fasteners have been developed around the cam locking principle to combine secure locking of cover plates and panels with the easiest possible access to the housed units. These special fasteners eliminate the possibility of accidental opening or loosening . . . eliminate rattles and provide a clean smooth appearance since only the stud head is visible on the exposed surface.

Q-1 Fasteners, illustrated at right, are designed for use where extreme loads are encountered. Their design provides a powerful lock which when assembled also has great structural strength. Installation is easy as there are only 3 parts—stud, cross pin and spring receptacle.

Q-2 Fasteners are similar in action to the Q-1 but the design has been simplified to speed up assembly and reduce costs. Where loads are not extreme the Q-2 provides fast locking and unlocking with long dependable performance assured.

Add the convenience of fast operation to the panels, doors and covers of your product. Write for Shakeproof Engineering Data Bulletin No. S-75 today!



Division of ILLINOIS TOOL WORKS
 2501 North Keeler Avenue, Chicago 39, Illinois
 Offices in Principal Cities

Plants at Chicago and Elgin, Illinois • In Canada:
 Canada Illinois Tool, Ltd., Toronto, Ontario

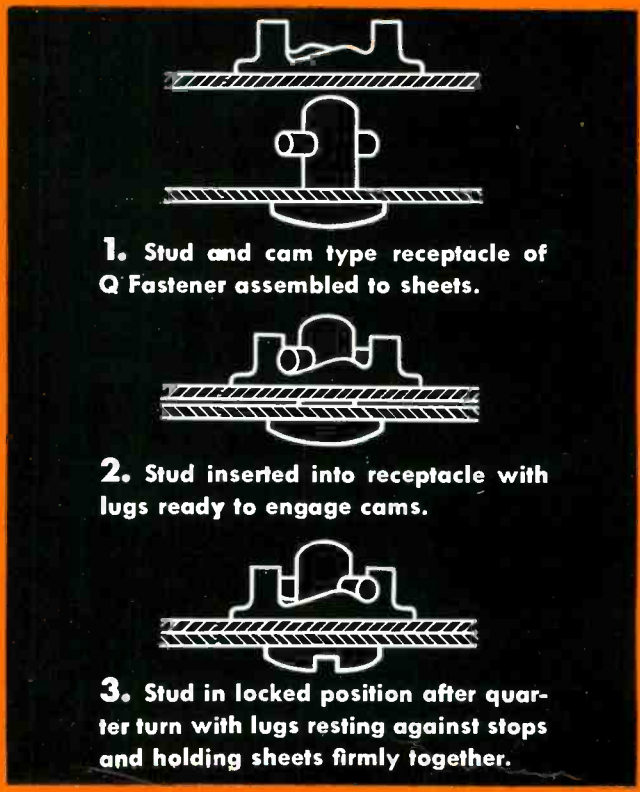

TWO STANDARD TYPES





TYPE GL-5545
 ... for armature control, involving low inductive loads. New gas-filled thyatron.

TYPE GL-3C23
 ... for field control, where inductive loads are heavy. A gas-and-mercury-vapor tube.

Available ... THE RIGHT G-E THYRATRON for every motor-control application!

Typical of General Electric's extensive and complete line of thyratrons are the two tubes shown here—each designed for a specific socket in a motor-control panel, and built to perform its assigned task better and more dependably than another type.

Why is mercury vapor also needed in a field-control thyatron with inert-gas content for quick heating? ... Because, due to the high inductive field load, current momentarily flows through the tube after the anode voltage has gone negative. Consequently, at the time the current stops, negative voltage across the thyatron causes bombardment of the metal tube parts by positive gas ions left in the tube. This results in gradual absorption of the gas. To compensate, mercury vapor is added as a conducting medium, in the form of a supply that constantly is being replenished from free mercury within the envelope.

The lower inductive load in armature-control work ordinarily causes minimum gas absorption ... there-

fore, a quick-heating thyatron such as the GL-5545, with inert-gas content only, is more efficiently employed for this service than other tubes of similar ratings, by reason of greater compactness of design and smaller over-all dimensions.

Every requirement of motor-control circuits now on your drawing-boards, is met by a G-E tube with the correct design and ratings. Nor is this "tailored-to-measure" selection confined to thyratrons! General Electric also builds and supplies the receiving-type tubes needed for your control panels—for example, the 6SN7-GT and 6AQ7-GT for use as d-c amplifiers.

G-E tube engineers are expert in aiding equipment designers to choose the tubes that will perform best and most economically in motor-control and other circuits. This friendly service is available to you on request! Phone or write your nearest G-E electronics office, or Electronics Dept., General Electric Company, Schenectady 5, N. Y.

RATINGS		
	GL-3C23	GL-5545
Filament voltage	2.5 v	2.5 v
current	7 amp	21 amp
heating time	15 sec	60 sec
Anode peak voltage, forward and inverse	1,250 v	1,500 v
peak current	6 amp	80 amp
avg current	1.5 amp	6.4 amp

GENERAL ELECTRIC

162-F4-8880

FIRST AND GREATEST NAME IN ELECTRONICS

MIRAGLAS IS THE NAME FOR VARNISHED TUBINGS THAT MEET OR EXCEED SPECIFICATIONS

SET BY VARNISHED TUBING ASSOCIATION AND
AMERICAN SOCIETY FOR TESTING MATERIALS



MIRAGLAS (FIBERGLAS) VARNISHED TUBINGS ARE MADE IN FOUR GRADES:

STANDARD GRADE for maximum flexibility, has little varnish and is recommended for high temperatures where dielectric strength is not a factor

DOUBLE SATURATED has all qualities of the Standard Grade but with additional coats of varnish to bring the dielectric rating up to 1500 volts.

TRIPLE STRENGTH is built up with coats of especially flexible insulation varnish for dielectric rat-

ings up to 2500 volts and is particularly suited where assembly operations include the possibility of rough handling.

IMPREGNATED is the Optimum in Superiority for high gloss, non-hydroscopic, resistance to high temperatures, oils, acids, etc. IMPREGNATED has a dielectric rating beyond 7000 volts and is unequalled for Long Life Under Most Severe Conditions. *Write For Samples.*

FOR USERS OF COTTON YARN VARNISHED TUBINGS The Mitchell-Rand MIRAC and HYGRADE Varnished Tubings of long staple fiber yarn are comparable to Fiberglas Tubings in dielectric ratings, tensile strength, flexibility and long life. *Write For Samples.*

Write today for your free copy of the M-R WALL CHART with its engineering tables, electrical symbols, carrying capacities of conductors, dielectric averages, thicknesses of insulating materials, tubing sizes, tap drills, etc.

M - R THE
ELECTRICAL
INSULATION
HEADQUARTERS
FOR 58 YEARS.



MITCHELL-RAND INSULATION CO. Inc.

51 MURRAY STREET • COrtlandt 7-9264 • NEW YORK 7, N. Y.

A PARTIAL LIST OF M-R PRODUCTS: FIBERGLAS VARNISHED TUBING, TAPE AND CLOTH • INSULATING PAPERS AND TWINES • CABLE FILLING AND POTHEAD COMPOUNDS • FRICTION TAPE AND SPLICE • TRANSFORMER COMPOUNDS • FIBERGLAS SATURATED SLEEVING • ASBESTOS SLEEVING AND TAPE • VARNISHED CAMBRIC CLOTH AND TAPE • MICA PLATE, TAPE, PAPER, CLOTH, TUBING • FIBERGLAS BRAIDED SLEEVING • COTTON TAPES, WEBBINGS AND SLEEVINGS • IMPREGNATED VARNISH TUBING • INSULATED VARNISHES OF ALL TYPES • EXTRUDED PLASTIC TUBING

PROGAR

(PROgram GuARDian)

the only limiter with a memory!

PROGAR* is a new instrument... Not just a Limiting or Governing amplifier, but a new device incorporating a *Guardian Memory circuit (Level Restoring Action)* with improved **PEAK LIMITING**.

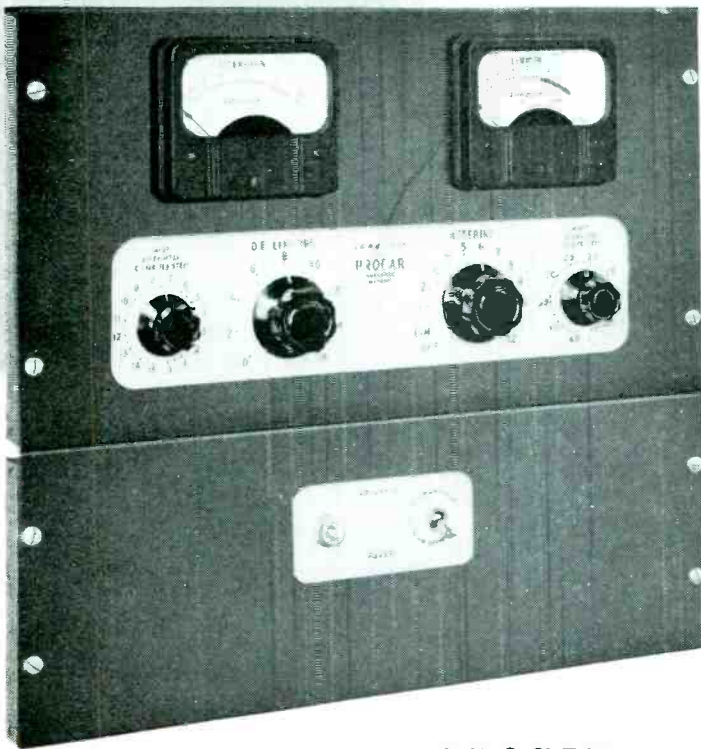

Dynamic expression is preserved in the PROGAR by the Memory (time delay) circuit in the Guardian. When the program level decreases this Memory Portion holds the gain constant for a predetermined adjustable period of time and then lets the Guardian slowly act to restore the program level to its original value.

The Guardian in the PROGAR precedes the Peak Limiting... therefore a regulated signal is fed into the limiter... maintaining consistent, pre-set peak limiter action and assuring a higher percentage of modulation than can be obtained with a limiter alone.

*Reg. U. S. Pat. Off.

**For Complete PROGAR information write for Bulletin #1011.
Shipments are being made now.**

Langevin Manufacturing Corporation

BROADCAST AUDIO FACILITIES • SOUND SYSTEMS • INDUSTRIAL CONTROLS

37 WEST 65TH STREET, NEW YORK 23, N. Y.

PDWG

means

better performance

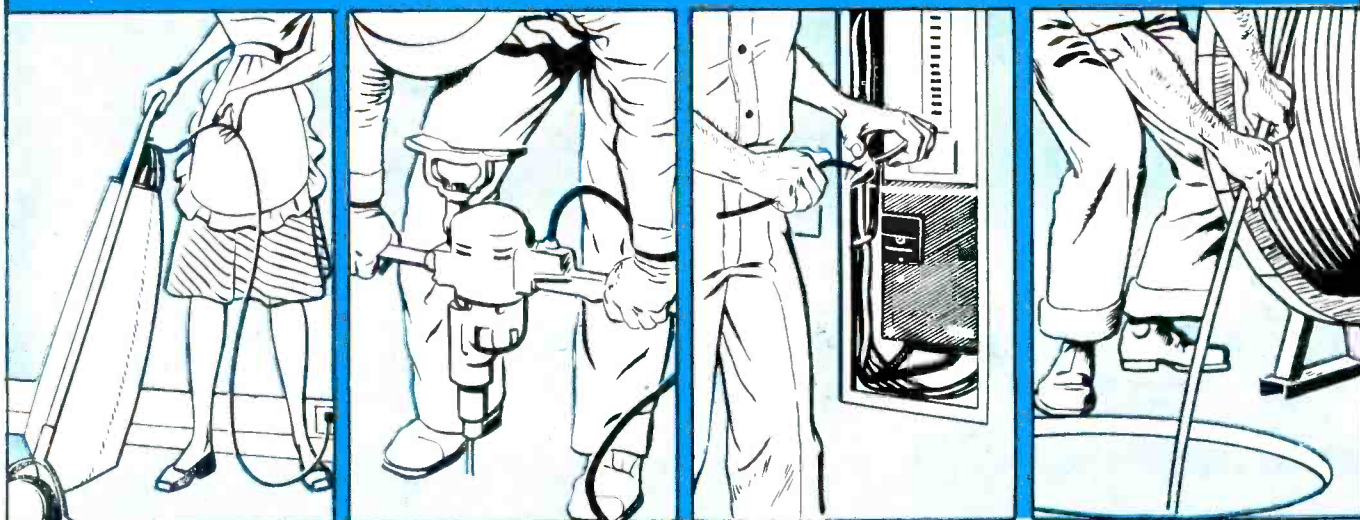



If you get PWC products when you buy cord sets, flexible cords, building wire, power cables, telephone wire, control cables or any other of the many PWC products, you get *all* the important advantages of electrical insulation.

Leading engineers specify PWC for all applications. Immunity to most hazards and uniform high quality of workmanship means greater dependability, uninterrupted service, longer life, lower maintenance and replacement costs.

Plastic Wire & Cable Corporation is the world's leading exclusive manufacturer of plastic insulated wire and cable, a pioneer in development of plastic insulations for dozens of new applications.

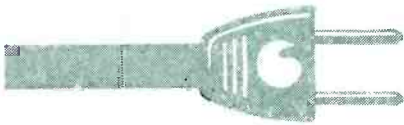

Our technical bulletin, packed with facts and figures on the advantages of plastic insulated wire and cable, is yours for the asking. Or send us your requirements and let our engineers show you how well PWC products will meet your needs. Write Plastic Wire & Cable Corp., 408 East Main St., Jewett City, Conn.

PWC

MEANS

10 WAYS BETTER

1. Superior dielectric strength.
2. Can't fray, crack or rot.
3. Low moisture absorption.
4. Greater mechanical strength.
5. Higher abrasion resistance.
6. Flexible over wide temperature range.
7. High chemical resistance.
8. Wide range of permanent, gem-like colors.
9. Non-combustible.
10. Lasting appearance.

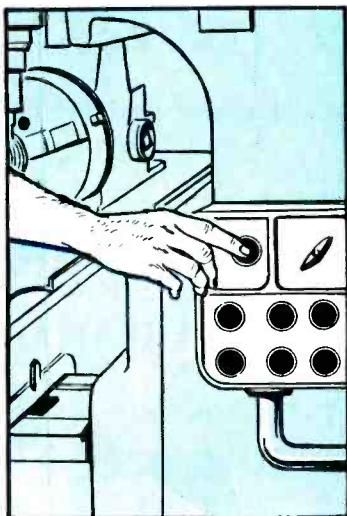

PLASTIC WIRE & CABLE CORP.

Jewett City, Conn.

World's leading exclusive manufacturer of plastic insulated wire and cable

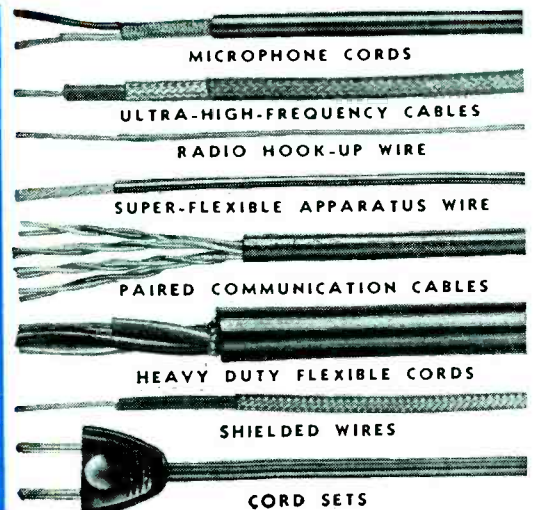

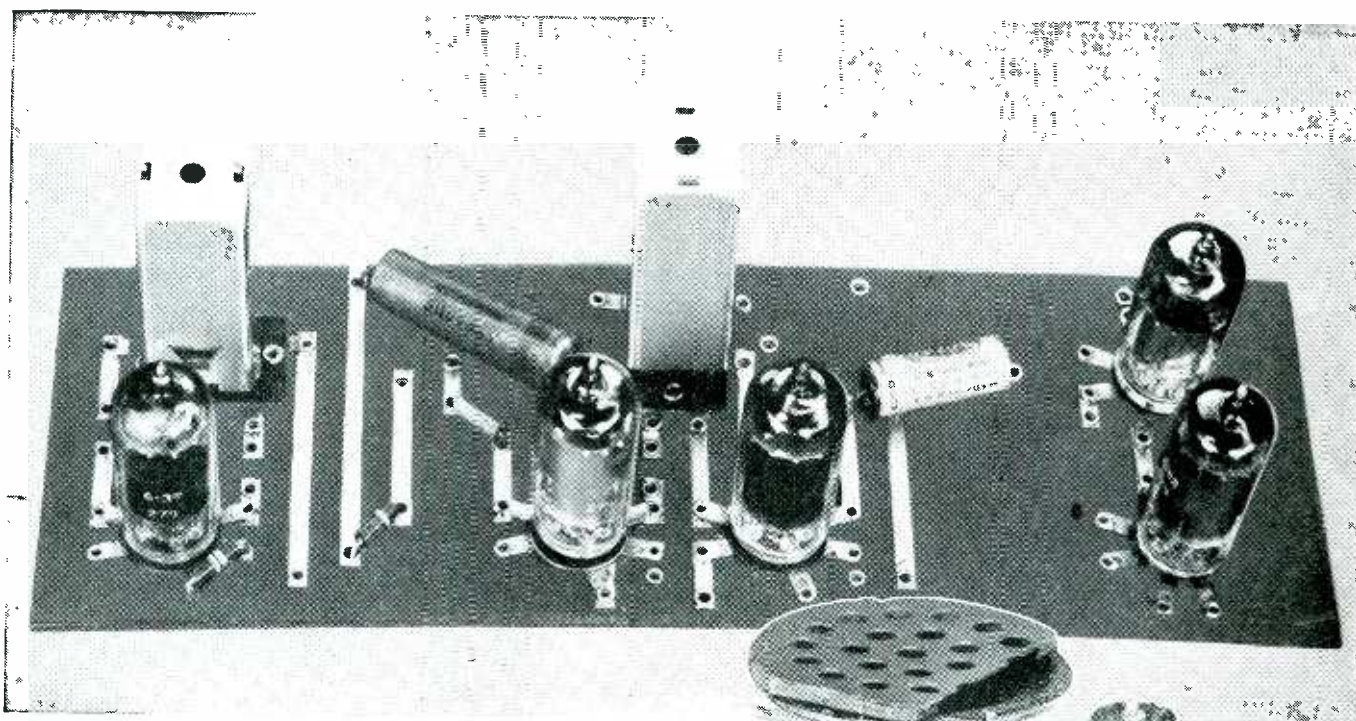

Stamped wiring deck, with tubes, transformers, capacitors and resistors, ready for assembly in metal chassis. This is a development of the Franklin Airloop Corp., New York City.

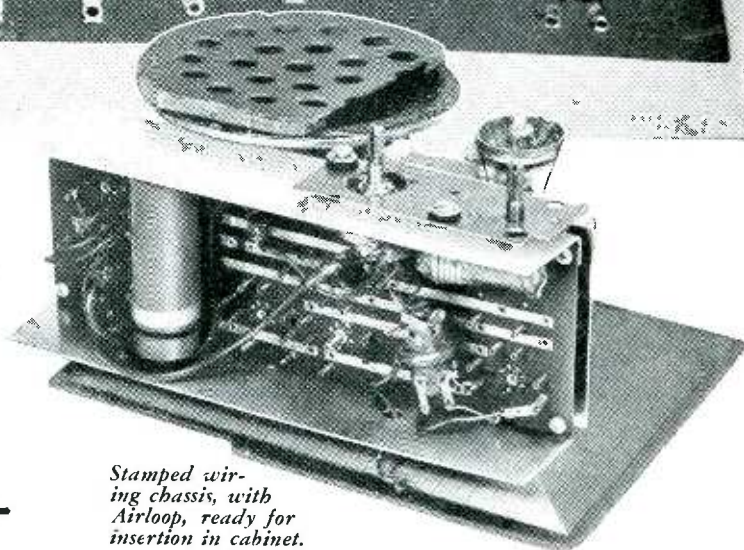

Stamped wiring chassis, with Airloop, ready for insertion in cabinet.

**Once again,
REVERE says—**

"Copper is the Metal of INVENTION"

STAMPED wiring offers new proof of the complete adaptability of copper to the development of new ideas. In this type of wiring, copper strips are stamped into both sides of an insulating sheet, the strips on one side running at right angles to those on the other. Connections between the two sides can be made by eyelets, pins, or other simple methods. It is estimated that with this system it should be possible to stamp about 90% of the wiring in the average radio or other electronic device. Thus many operations such as cutting, skinning, cabling and soldering wires should be almost completely eliminated. This new idea, though still in the development stages, will also make possible large economies in the telephone and communications fields, and for measuring instrument panelboards of airplanes, ships, and automobiles. The copper used is Revere OFHC.

Revere produces many metals, and is glad to collaborate with the electronic industry in such matters as

selection and fabrication. These metals are available in mill products, as follows: *Copper and Copper Alloys:* Sheet and Plate, Roll and Strip, Rod and Bar, Tube and Pipe, Extruded Shapes, Forgings; *Aluminum Alloys:* Tube, Extruded Shapes, Forgings; *Magnesium Alloys:* Sheet and Plate, Rod and Bar, Tube, Extruded Shapes, Forgings; *Steel:* Electric Welded Steel Tube.

REVERE

COPPER AND BRASS INCORPORATED

Founded by Paul Revere in 1801

230 Park Avenue, New York 17, New York

Mills: Baltimore, Md.; Chicago, Ill.; Detroit, Mich.; New Bedford, Mass.; Rome, N. Y.—Sales Offices in Principal Cities, Distributors Everywhere.

Airtronics

DUAL PREHEATERS

Get These Three Plus Values
with

FEDERAL'S 7C25 Power Triode

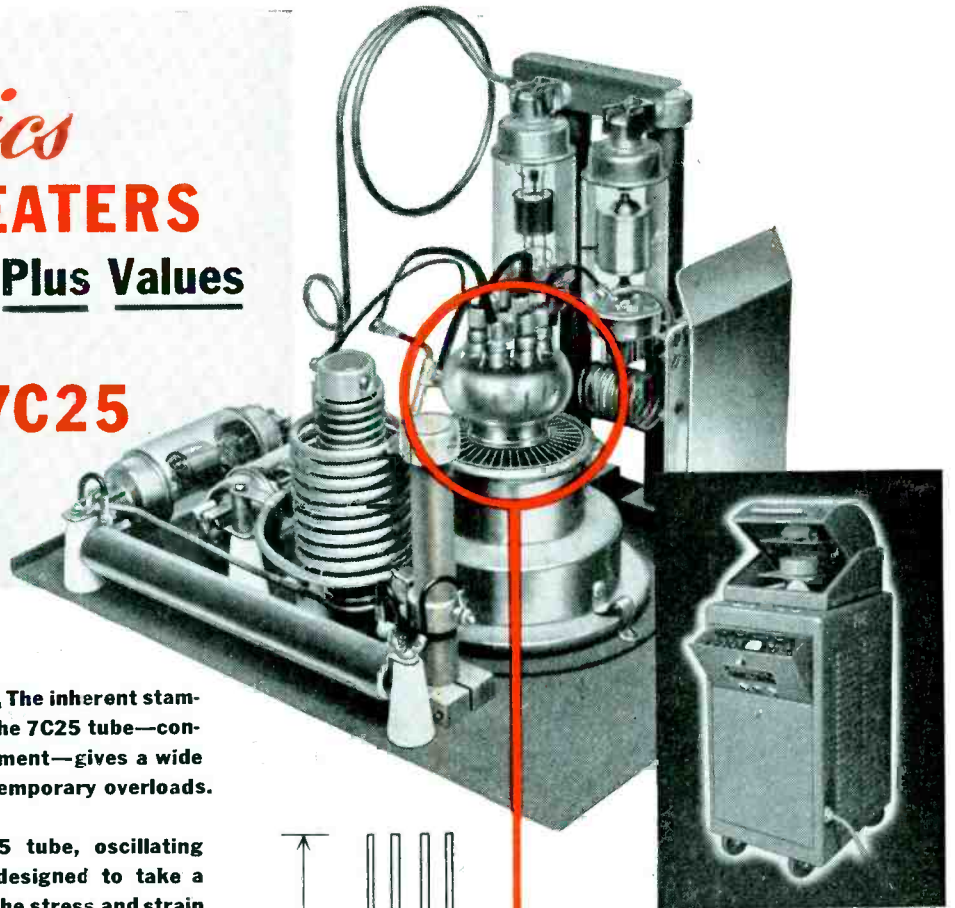

- 1 Extra Reserve Power.** The inherent stamina and overload capacity of the 7C25 tube—conservatively rated in the equipment—gives a wide margin of reserve power for temporary overloads.
- 2 Longer Life.** The 7C25 tube, oscillating heart of the equipment, is designed to take a beating—to last longer under the stress and strain of heavy duty service.
- 3 Smaller Size.** The 2.5 KW Dual Preheater measures only 18"x22"x36"—small enough to locate almost anywhere in crowded molding plants.

On today's hard-hitting production lines, electronic equipment—like this Airtronics dielectric heating unit—has to take plenty of abuse. The terrific strains of sudden load changes, mechanical shock and vibration are just part of the day's work—a hard life for any electronic tube. But the 7C25, like all Federal industrial tubes, is built for just this kind of service—to give high-frequency power, plus an ample margin of emergency overload capacity.

Internal elements are widely spaced and ruggedly constructed to fortify against vibration. Flexible leads simplify installation—and very little unshielded glass is used, minimizing possibility of breakage. Every tube is thoroughly checked for perfection of performance and construction—including *three* X-ray tests to seek out hidden flaws. These exacting requirements assure longer tube life on the production line—fewer replacements—lower up-keep costs.

For complete information and prices, write Federal today — Dept. L713.

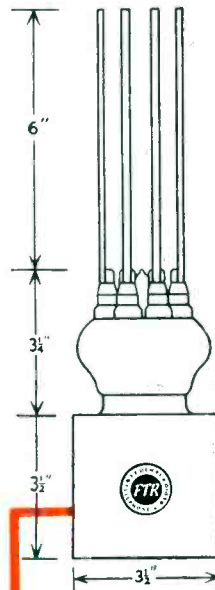

Model DH, 2.5-Kw, 27.4-megacycle dielectric preheater, made by the Airtronics Manufacturing Co., of N. Y., Chicago and Los Angeles. Enlarged view shows 7C25 tube in grounded-anode oscillator. Airtronics Dual Preheaters are also available in 5 Kw rating, Model EK, using two 7C25's in parallel.

DATA FOR 7C25 TUBE

Filament voltage	11.0 volts
Filament current	27.5 amp.

Maximum Ratings for Maximum Frequency of 50 Mc

DC Plate voltage	4500 volts
DC Plate current	1.25 amp.
Plate dissipation	2500 watts
Type of cooling	Forced air



KEEPING FEDERAL YEARS AHEAD... is IT&T's world-wide research and engineering organization, of which the Federal Telecommunication Laboratories, Nutley, N. J., is a unit.

Federal Telephone and Radio Corporation

100 KINGSLAND ROAD CLIFTON, NEW JERSEY

In Canada: — Federal Electric Manufacturing Company, Ltd., Montreal.
Export Distributors: — International Standard Electric Corp., 67 Broad St., N. Y. C.

SOLITE*

SPACE-SAVING SELF-HEALING CAPACITORS

SOLITE metallized paper capacitors are the most important capacitor development in years

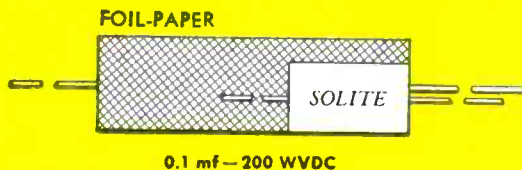

These truly tiny capacitors, with their unique self-healing properties, are the answer to many problems facing designers of modern electronic equipment.

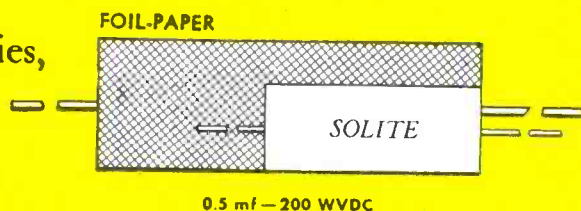

Their small size, long life, and excellent r-f characteristics are unequalled by comparable conventional foil-paper capacitors.

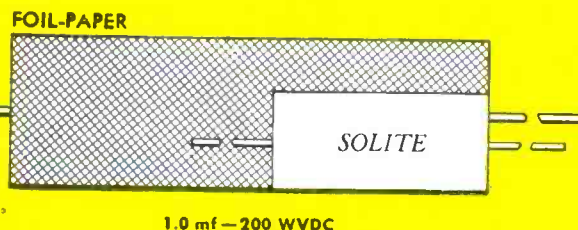

SOLITE Capacitors are now being shipped in ever increasing quantities.

For full details write today for Bulletin SPD-110 to

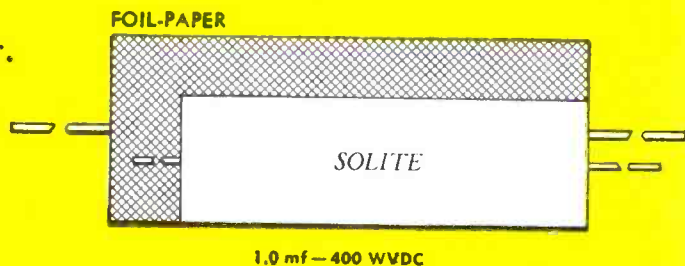

Solar Manufacturing Corporation
1445 Hudson Blvd., North Bergen, N. J.

WHEN SPACE IS TIGHT, USE SOLITE

*Trade Mark Solite Capacitors are fully protected by U. S. letters patent and patents pending.



SOLAR CAPACITORS
"Quality Above All"

Centralab Announces a New and Revolutionary

LEVER SWITCH

With a Minimum Life Test of 25,000 Cycles!

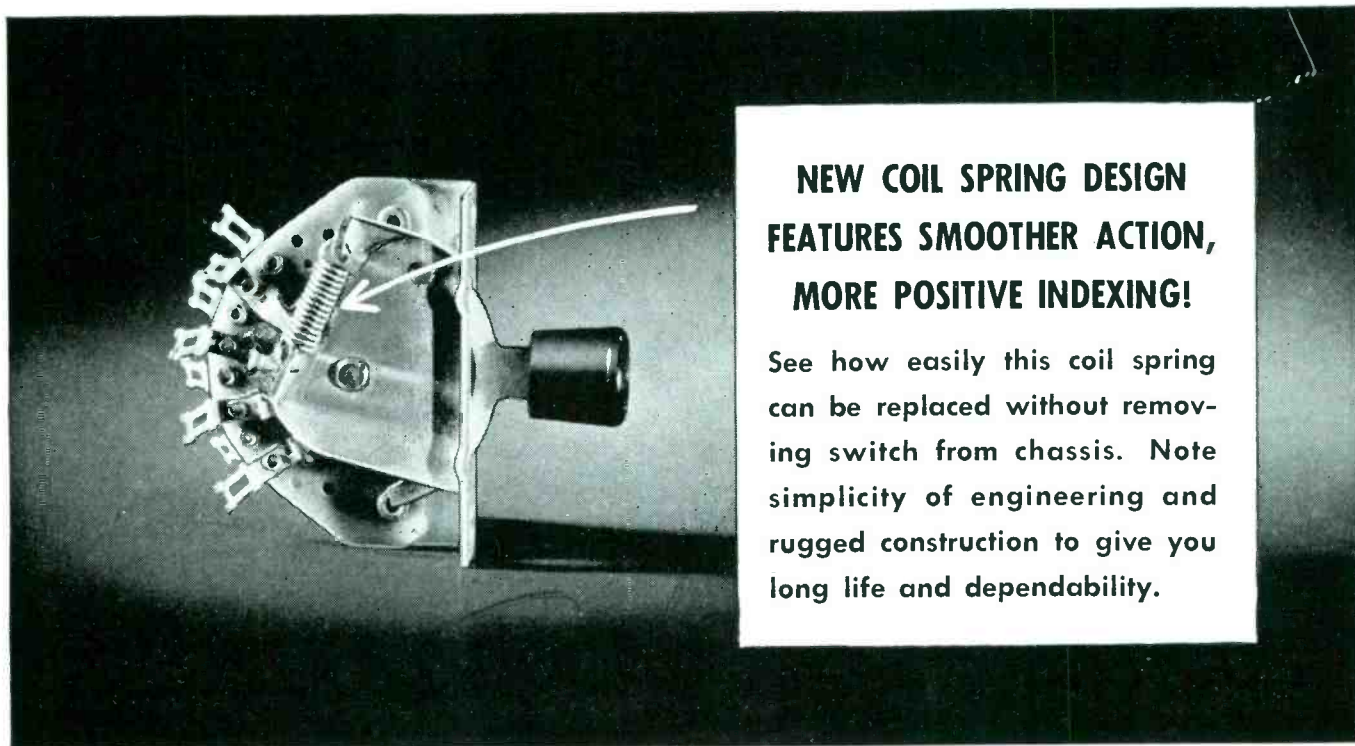

**NEW COIL SPRING DESIGN
FEATURES SMOOTHER ACTION,
MORE POSITIVE INDEXING!**

See how easily this coil spring can be replaced without removing switch from chassis. Note simplicity of engineering and rugged construction to give you long life and dependability.

8 Basic Combinations of Indexing Available!

COMPARE the outstanding features of Centralab's new lever switch, and you'll see why it's the finest product of its kind available today!

New, exclusive coil spring design with cam and roller offers you new dependability, long life and resistance to hard service for inter-com and test equip-

ment use. Guaranteed minimum life of 25,000 cycles.

Combinations of spring return and positive indexing provide a flexibility which makes it adaptable to almost any circuit requirements. Available with shorting or non-shorting contacts, or combination of both. Low capacity. 30 degree indexing. Rated at 6 watts. Brass silver-plated clips and contacts. All other metal parts cadmium-plated steel.

Send today for complete information and bulletin number 970.



Ceramic Trimmers
Bulletin 630



Ceramics
Bulletin 720



Variable Resistors
Bulletin 697



Ceramic Capacitors
Bulletin 630



Selector Switches
Bulletin 722

Centralab
Division of GLOBE-UNION INC., Milwaukee

IT'S THIS EASY TO INSTALL A

MERELY CHOOSE THE
COUNTER MEETING YOUR
REQUIREMENTS OF SPEED AND
TOTAL COUNT

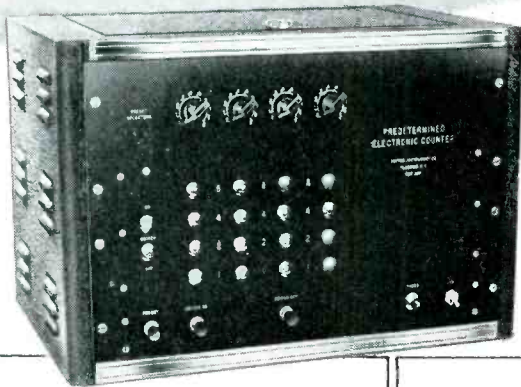

HIGH SPEED POTTER PREDETERMINED ELECTRONIC COUNTER

Potter Predetermined Electronic Counters extend the field of automatic counting and control far beyond the scope and capabilities of existing mechanical devices. Completely electronic in operation they eliminate errors usually caused by wear, slippage and inertia. Counting rates are in excess of 20,000 per second, control speeds up to 15,000 per minute. Accuracy is absolute. Potter counters are available in many types and sizes all designed for many years of service.

To Count Small Objects of Varying
Size, Shape and Opacity—

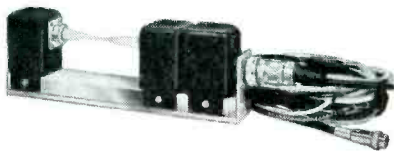

Potter photoelectric count detectors are available in two types: Model 600, high resolution type illustrated counts small objects of any shape including 10 mill jewelers screws. It responds to changes in light as small as 20 percent therefore complete separation of articles to be counted is not required. Model 602 (not shown) counts large objects—cartons, bottles, etc.

To Count Shaft Rotation, Coil Turns
or for Linear Measurement as a
Function of Rotation—



The electro-magnetic pick-up coil is readily arranged to count shaft rotation. A steel slug is mounted on the shaft. This slug intercepts the airgap of the pick-up coil once per revolution and injects a pulse into the counter. Higher definition of fast rotation can be obtained by mounting several slugs on the shaft to provide multiple counts per revolution.

For Counting or Measuring Velocity
of Fast Moving Objects Such as
Bullets or Projectiles—



These photoelectric screens are widely used to measure small arms projectile velocities. The light source, a lumiline lamp is built into the top. The bottom houses a photoelectric cell, amplifier and power supply. A missile passing through any portion of the screen generates a count pulse for the Potter Timer or Counter.

USE ONE OF THESE EASY-TO-APPLY METHODS OF ELECTRONIC COUNT DETECTION

For High Speed Counting of Stacked
Paper or Other Sheet Material

The stylus count detector consists of detector head and stylus point. By running the point over the side of a stack of cards, paper, envelopes, etc., an accurate count is rapidly obtained. This method can also be used to check the surface quality of materials.

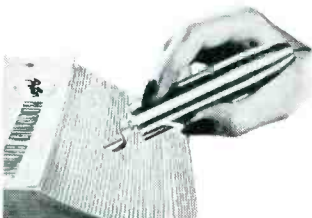

What Is Your Problem?
Potter Equipment Counts Anything—



These detectors, and many other types available, make it possible to count any moving object irrespective of size, shape, material or speed. It is also possible to measure the velocity or magnitude of any motion—reciprocating, rotary or linear. Accuracy is absolute. It is a simple matter, with Potter equipment, to convert these counts and measurements into automatic control action.

Write for these Informative
Data-Catalog Sheets—



For consultation on any high speed counting
timing or control problem, address Dept. 6-D

POTTER INSTRUMENT CO.
INCORPORATED
136-56 ROOSEVELT AVENUE • FLUSHING • NEW YORK



WILCOX AIRBORNE COMMUNICATION EQUIPMENT

*Protected against
destructive Vibration*

with the **LORD**

VIBRATION CONTROL SYSTEM

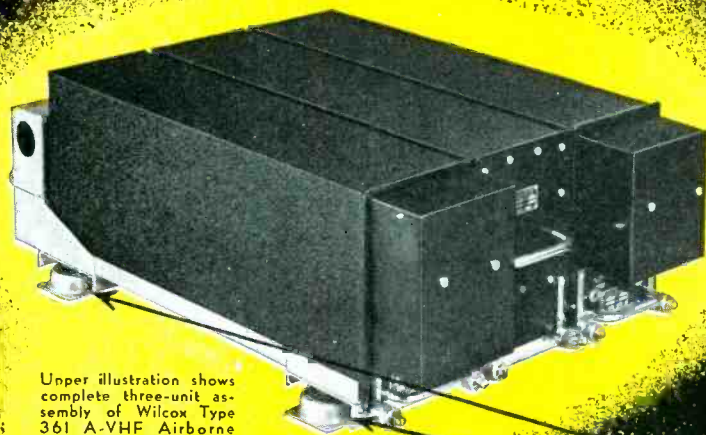

Upper illustration shows complete three-unit assembly of Wilcox Type 361 A-VHF Airborne Communications equipment.

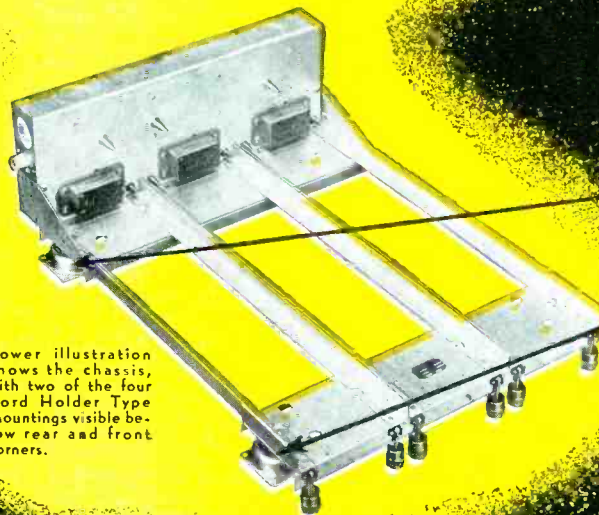

Lower illustration shows the chassis, with two of the four Lord Holder Type Mountings visible below rear and front corners.



Thorough engineering characterizes this Wilcox Airborne Communications unit. Customers like its unit construction . . . provision for quick, easy removal of individual units for servicing . . . the positive protection of vital parts obtained by its Lord Vibration Control System.

Like other progressive manufacturers, Wilcox Electric Co., Inc. considers vibration control an essential part of good design. Delicate parts last longer . . . require less maintenance and adjustment . . . operating characteristics are stabilized . . . all these features contributing to lasting customer satisfaction.

Whether you make electronic equipment or any other product, you can increase your sales by eliminating costly, destructive vibration. It will pay you to consult Lord . . . make us your headquarters for product improvement through Vibration Control.

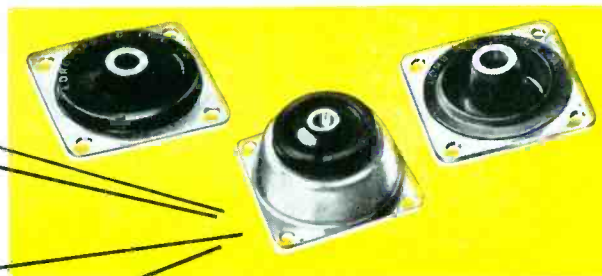

Get positive protection from vibration in communication-radio equipment and instruments with LORD Mountings.

The Lord line of mountings covers a complete range of styles, shapes, and sizes to fill your mounting requirements. Literature and information available on request. Or contact your Lord Field Engineer—he'll assist in selecting mountings for your product.



MAKE GOOD PRODUCTS BETTER

with *Vibration Control*

LORD MANUFACTURING CO. • ERIE, PA.

Field Offices: Detroit • Chicago • New York • Washington, D.C.
Providence, R. I. • Burbank, Cal. • Philadelphia, Pa.

Canadian Representative: Railway & Power Engineering Corp., Ltd.

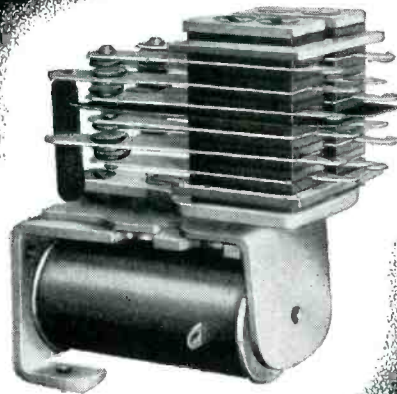

ALLIED UA and UB *Versatile Power Relays*

With these versatile relays you can eliminate the trouble and expense of applying many different relays on equipment where one basic type can be used. The Allied UA with light arm contacts, and the Allied UB with heavy arm contacts and higher dielectric strength and creepage distances, make standardization practical and inexpensive.

Accurately machined iron-to-iron hinge piece means lower magnetic loss and machine-ground pole-piece provides perfect armature seating.

Other features of these versatile Allied power relays:

- Fine silver contacts that handle any load from 3 to 15 amperes at 24 volts D.C. or 110 volts A.C. (non-inductive).
- Operating coil voltages up to 220 volts A.C. and 120 volts D.C.
- Variety of contact arrangements . . . from single-pole to four-pole double-throw.
- Either horizontal or vertical mounting-frame for maximum adaptability.

Write for detailed information.

DIMENSIONS

Length 2 1/2"
 Height 2 1/4"
 Width 1 1/4"

AL-115



ALLIED CONTROL COMPANY, INC.
 Dept. B, 2 East End Avenue • New York 21, N. Y.



For **Blue Ribbon Quality**
in
Sheet Metal Housings

Send Your **Blueprints** to **Karp**

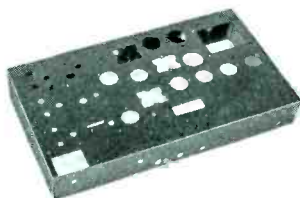
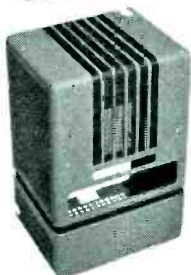
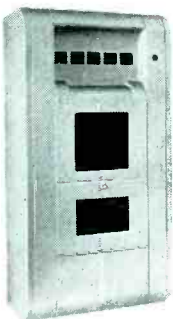

When manufacturers of electronic, radio and electrical apparatus, situated as far as **2000 miles** and more from our plant, insist on Karp sheet metal craftsmanship, there must be good and profitable reasons.

One important reason is that Karp-constructed cabinets, enclosures, housings and chassis are **custom-built to individual requirements**; so precisely and uniformly made that time and money are saved on your assembly line. Another reason is that Karp builds good looks and streamlined styling into the product, giving you added sales and profit advantages.

Remember the Karp blueprint man symbolizes blue ribbon quality in **cabinets, housings, enclosures and chassis**. Tell us your needs. Get our quotations.



- Any metal
- Any gauge
- Any size
- Any quantity
- Any finish

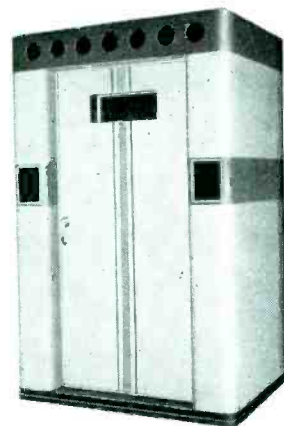
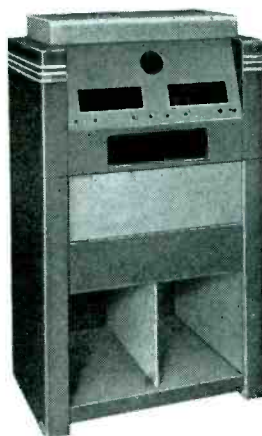

KARP METAL PRODUCTS CO., INC.

124 - 30th STREET, BROOKLYN 32, NEW YORK

Custom Craftsmen in Sheet Metal

FOR SPECIALIZED APPLICATIONS...

THE NEW BASIC CATHODE-RAY INDICATOR Type 281



Type 281 as an independent unit

- A basic instrument for needs too specialized or advanced for equipment hitherto available.
- Choice of 4 kv or 8 kv accelerating potential; self-contained power supplies.
- Recordable writing rates of single transients exceed 4 in./ μ s.
- No amplifiers or time base, but coupling to all deflection plates, grid and cathode on front panel; direct connection to deflection plates on top of instrument.
- Relay-rack or cabinet mounted.

ITS NEW SUPPLEMENTARY HIGH-VOLTAGE POWER SUPPLY Type 286



Type 286 as an independent unit

- Exceptionally safe for operator.
- Output potential continuously variable between + 18 kv and + 25 kv.
- Regulation within 5% for $\pm 10\%$ line voltage change or 0 to 500 ma. load variation.
- Direct-reading output voltmeter accurate within $\pm 2\%$ of full scale.
- Used in standard relay-rack or own dust-proof cabinet.
- May be fastened to Du Mont Type 281.

When combined

- FULL capabilities of the high-voltage Type 5RP-A Cathode-Ray Tube are realized.
- Excels the cold-cathode continuously-evacuated type tubes for photographic recording.
- Writing rate for the Type 5RP-A Tube now exceeds 400 in./ μ s.! Note unretouched photo of single transient containing writing rates of 400 in./ μ s. at right.

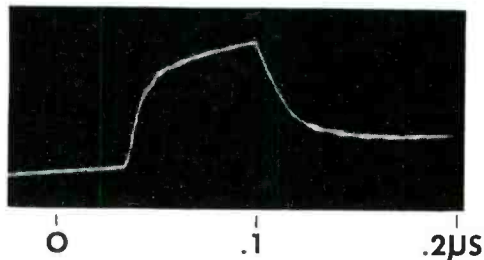

► Details on request

© ALLEN B. DUMONT LABORATORIES, INC.

DUMONT

Precision Electronics & Television

ALLEN B. DUMONT LABORATORIES, INC., PASSAIC, NEW JERSEY • CABLE ADDRESS: ALBEEDU, PASSAIC, N. J., U. S. A.

400 INCHES IN A MILLIONTH OF A SECOND!

From 4000 to 29,000 accelerating volts applied by means of the new special-application indicator combination—Type 281 Indicator and Type 286 High-Voltage Power Supply—shown below.



THE IDEAL COMBINATION!

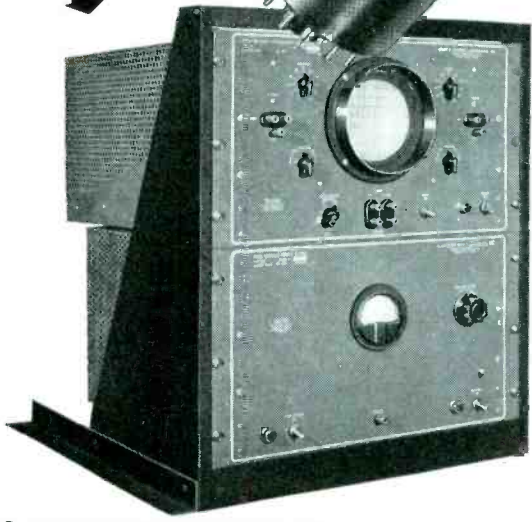

A spot moving at this speed may now be photographed with the

DU MONT Type 5 RP-A CATHODE-RAY TUBE

▶ Du Mont Type 5RP-A, the very latest thing in high-voltage cathode-ray tubes, may now be exploited to its fullest capabilities for a performance that equals or even excels the cold-cathode, continuously-evacuated, bulky and costly cathode-ray tube. This means that writing rates of 400 in./ μ s. may now be recorded. A special indicator combination of the Du Mont Type 281 Cathode-ray Indicator and the Type 286 High-Voltage Power Supply provides accelerating potentials up to 29 kv. Thus the Du Mont Type 5RP-A tube now extends the range of cathode-ray oscillography into an unlimited field of advanced applications.

▶ Details on request

© ALLEN B. DU MONT LABORATORIES, INC.

DU MONT Precision Electronics & Television
ALLEN B. DUMONT LABORATORIES, INC., PASSAIC, NEW JERSEY • CABLE ADDRESS: ALBEEDU, PASSAIC, N. J., U. S. A.



117 V
A-C SUPPLY

30 TO 50
M F

TO CONVENTIONAL
DIVIDER AND
FILTER

THE NEW GENERAL ELECTRIC SELENIUM RECTIFIER

Typical diagram for radio receivers with the new General Electric selenium rectifier. A ballast resistor "R" is usually provided, to limit the output voltage of the rectifier to that required by the particular circuit. The value of "R" is usually between 25 and 50 ohms, but may be modified to meet any particular circuit requirements.

☆
is a space saver

☆
is a cost saver

☆
is a time saver

Here's important news for designers and manufacturers of small radio sets. Now your problems of designing assemblies for small cabinets can be simplified with this new General Electric selenium rectifier.

It takes up *less than one cubic inch* of space, and can be used in cramped quarters where sockets and tubes just won't fit.

It requires no socket or filament circuits. Only two soldering operations and a minimum of mounting hardware are required, and the job is done at a fraction of the usual installation cost.

It is compact, to permit the design of smaller assemblies and smaller cabinets, and to provide more room for other parts. And, best of all, it is available to you now.

These new General Electric selenium rectifiers are made in two small sizes. They are suited for use in radio receivers and in other electronic equipment. If you wish more information on the application of these rectifiers to your designs, or if you would like additional specification data, write to Section A91-931, General Electric Company, Bridgeport 2, Connecticut.



Other Important Features

Ample Current Capacity — Will safely withstand the inverse peak voltages obtained when rectifying (half-wave) 110-125 volts, rms, and feeding a capacitor as required in various radio circuits.

Withstands Ambient Temperatures of 50 C to 60 C — Ratings are based on the ambient temperatures usually encountered in the cabinets of small radio receivers.

Moisture-resistant — Each complete rectifier assembly is coated with a moisture-resistant varnish, to provide protection from humidity and condensation.

Strongly Built for Reliable Service — Constructed to provide constant and uniform spring-contact pressure on the cells, regardless of temperature variations, General Electric selenium rectifiers will give long, dependable performance.



GENERAL ELECTRIC

A Statement of Facts re "Permanent" Points

By MAXIMILIAN WEIL

The term "permanent", as applied to a reproducing needle, has always seemed to me unfortunate. The fact that there is no such thing as a "permanent" point makes the question of whether or not a reproducer has a replaceable stylus point vastly important.

The idea of not having to make needle changes, or of making such changes as seldom as possible, has always had a strong appeal; but the very nature of a stylus and a record surface—and their inevitable reaction, one upon the other—preclude indefinite plays without changing—that is, if any semblance of high grade reproduction and the records themselves are to be preserved.

You know what would happen to a stylus if it were held in contact with a grindstone for, say, an hour or so (which represents just about one dozen 12-inch disc plays).

That is just about what happens when a jewel point is played again and again and again! Dur-

ing the first few dozen plays, the physical shape of the stylus point is altered by the abrasive content of the record. From then on, the story gradually reverses and the stylus begins to take revenge on the record, by cutting down and eroding the glazed surface.

Thus, the longer one stylus be used—the more rapid the destruction of the disc.

A genuine Sapphire jewel point is the best stylus known, where any degree of permanency is desired. Such a point can bravely maintain its shape up to perhaps two hundred and fifty plays of commercial records. (Of course, this condition is much more favorable with acetate and better transcription records.)

The use of Diamond instead of Sapphire means only that it takes somewhat longer to grind a cutting edge on the stylus—then, being harder than Sapphire, the Diamond will erode record grooves at a faster rate. True, records can be and are be-

ing played, on and on, far beyond two hundred and fifty plays with the same stylus. However, by this slow and inexorable process, discs are progressively eroded by each play—till, finally, the greatly increased surface noise and distortion become all too evident—by which time it is too late to do anything about the damage to several hundred discs.

The foregoing assumes the use of a pick-up possessing the essentials demanded by modern records. Old type pick-ups would erode the discs much more rapidly.

A genuine jewel, then, is the best stylus, but, like everything else, has recognized limitations. By observing this fact, and periodically replacing the stylus about every four months, or whatever time it takes to play two hundred and fifty 12-inch discs in any given case—records can be preserved indefinitely. This, obviously, calls for a reproducing unit designed with a stylus **easily replaceable by the user.**

AUDAX engineers have worked on this problem for years. We now offer you TUNED-RIBBON, a reproducer that can, in every way, give you the performance expected from modern discs, and which, in addition, is equipped with a jewel point **READILY REPLACEABLE BY THE OWNER.** TUNED-RIBBON lets you change stylus, after the proper number of plays have been performed, without sending the unit back to us. Specifications:—adequate output without pre-amplification—near-zero mass—linear response to over 10 k. c.—point-pressure 24 grams, and less—no torsional action—exceptionally clean-cut *facsimile* performance. Investigate this revolutionary new system.

A Model For Every Purpose Listing at \$33 to \$195

AUDAK COMPANY

500 Fifth Ave.,

New York 18

CREATORS OF FINE ELECTRO-ACOUSTICAL APPARATUS SINCE 1915

lightweight • compact • built-in power-unit

Standard aircraft RADIO



V.H.F. TRANSMITTER
—RECEIVER

Employing

MINIATURE COMPONENTS

and

**MINIATURE
TECHNIQUE**

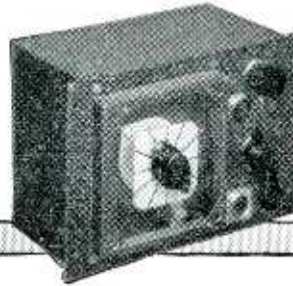

STR 12

12 spot frequencies

A lightweight, high performance transmitter/receiver with twelve 'switch-and-talk' channels.

WEIGHT : 20 lb.

TOTAL INPUT : Transmit-165 W } at 26.5V.
 Receive - 123 W }

FREQUENCIES : 12 Spot frequencies (12 send —12 receive), remotely selected in the band 118-132 Mc/s.

SERVICE : Telephony & M.C.W.

Standard Telephones and Cables Limited • TELECOMMUNICATION
ENGINEERS • OAKLEIGH ROAD • NEW SOUTHGATE • N11
LONDON

Problems solved by Richardson...in Plastics

2 - DESIGN OF A PLASTIC AIRCRAFT GEAR

PROBLEM: MAGNETO GEAR AS ORIGINALLY DESIGNED WAS A DISK OF INSUROK LAMINATED MATERIAL, BORED & THREADED ON THE INSIDE DIAMETER, & SCREWED ONTO A METAL SPIDER. AFTER WHICH, HOLES WERE DRILLED THROUGH THREADED SECTIONS, INTO WHICH METAL PINS WERE DRIVEN & RIVETED. THIS METHOD OF ASSEMBLY PROVED INEFFICIENT DUE TO THE STRENUOUS STRESSES REQUIRED FOR AIRCRAFT, & DISKS HAD TENDENCY TO LOOSEN. THUS THE PROBLEM WAS TO SECURE A PERMANENT MOUNTING WHICH COULDN'T BE LOOSENED FROM THE SPIDER.

SOLUTION: RICHARDSON PLASTICIANS RECOMMENDED ADOPTION OF MOLDED PROCEDURE. INSTEAD OF THREADING THE SPIDER, THIS SECTION WAS DEEPLY KNURLED & A CENTRAL GROOVED RECESS WAS CUT AFTER KNURLING. THE SPIDER WAS MOUNTED IN A SUITABLE MOLD & DISKS OF SATURATED MATERIALS WERE MOLDED INTO PLACE. MATERIAL FILLED RECESS & KNURLED PORTIONS TO GIVE PERFECT BONDING.

WHEN ELECTRICAL FLASH-OVERS OCCURRED AT LATER DATE, MOLD WAS CHANGED TO PERMIT INCLUSION OF SATURATED DISKS TO COVER METAL WHERE FLASH-OVERS OCCURRED. THIS DESIGN CHANGE ELIMINATED ALL PREVIOUS DIFFICULTIES.

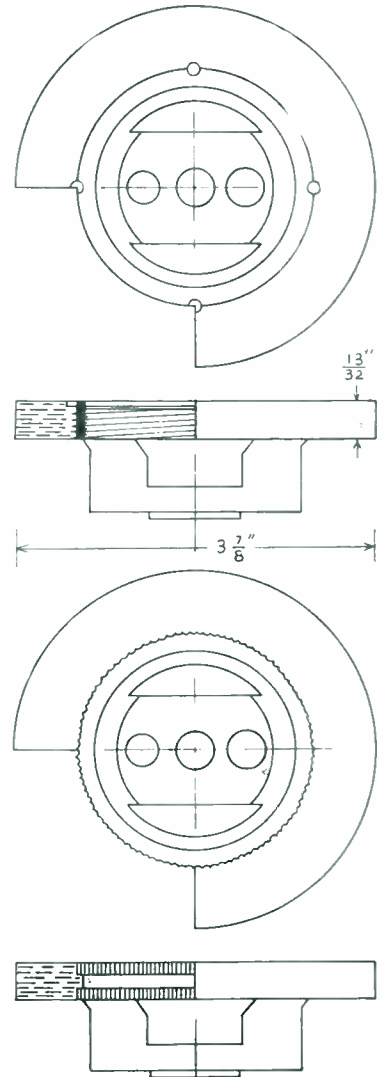

INSUROK Precision Plastics

INSUROK is the family name of a great variety of laminated and molded plastic products produced by Richardson. Laminated INSUROK is available in sheets, rods, tubes, punched and machined parts, made with paper, fabric, glass, etc. Molded INSUROK products are made from Beetle, Bakelite, Plaskon, Tenite, Styron, Durez, Lucite, etc., by compression, injection and transfer molding.

The RICHARDSON COMPANY

Sales Headquarters: MELROSE PARK, ILL. FOUNDED 1858 LOCKLAND, CINCINNATI 15, OHIO
NEW YORK 6, 75 WEST STREET ROCHESTER 4, N. Y., 1031 SIBLEY TOWER BLDG.
PHILADELPHIA 40, PA., 3728 NO. BROAD STREET MILWAUKEE 3, WIS., 743 NO. FOURTH STREET
CLEVELAND 15, OHIO, 326-7 PLYMOUTH BLDG. ST. LOUIS 12, MO., 5579 PERSHING AVENUE
DETROIT 2, MICH., 6-252 G. M. BLDG. INDIANAPOLIS, IND.
Factories: MELROSE PARK, ILL. NEW BRUNSWICK, N. J.

RICHARDSON MEANS *Versatility* IN PLASTICS

A PERMANENT MAGNET OF INDALLOY MAY DO IT BETTER



Indalloy!

...newest SINTERED "PACKAGED ENERGY"

MATERIAL PRODUCED BY THE INDIANA STEEL PRODUCTS COMPANY

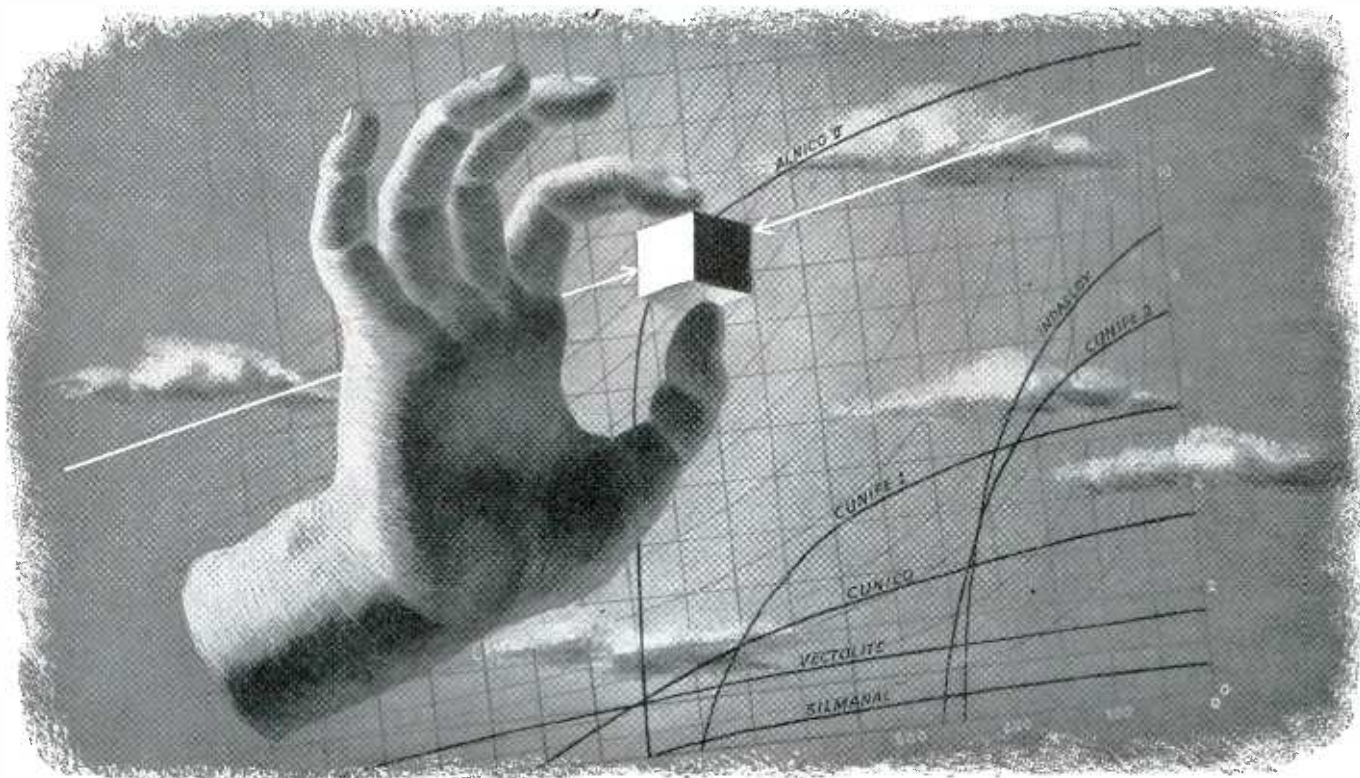

***Newest of the most modern magnetic materials— including the Alnicos, Cunico, Cunife, Vectolite and Silmanal— is INDALLOY, a sintered alloy of different permanent magnet components.**

Powdered metallurgy involved in the production of INDALLOY permits low-cost mass production of small magnets to comparatively close tolerances.

INDALLOY is another step forward. Today's frontiers in the field of magnetism are fast expanding as engineers and physicists are becoming aware of the potential of new materials like INDALLOY . . . which, because of their versatile structure, are now making possible functional new designs formerly too costly or mechanically impractical.

INDALLOY may do some job or process better in your industry. Our engineering staff welcomes your investigation into the use of modern magnetic materials. As evidence of our faith in the future applications, our Chauncey, N. Y. plant, newest of its kind in the world today, is devoted to the exclusive production of these new magnet materials. Magnets of the future are today being fashioned from "Packaged Energy" materials.

For complete details on INDALLOY and the famous family of new, functional permanent magnet materials, please write for our new, free ENGINEERING BULLETIN EBM-102.

★ THE INDIANA STEEL PRODUCTS COMPANY ★

PRODUCERS OF "PACKAGED ENERGY"
6 NORTH MICHIGAN AVENUE • CHICAGO 2, ILL.



SPECIALISTS IN PERMANENT MAGNETS SINCE 1910
PLANTS { VALPARAISO, INDIANA
CHAUNCEY, WESTCHESTER COUNTY, N. Y.

©1946 The Indiana Steel Products Co

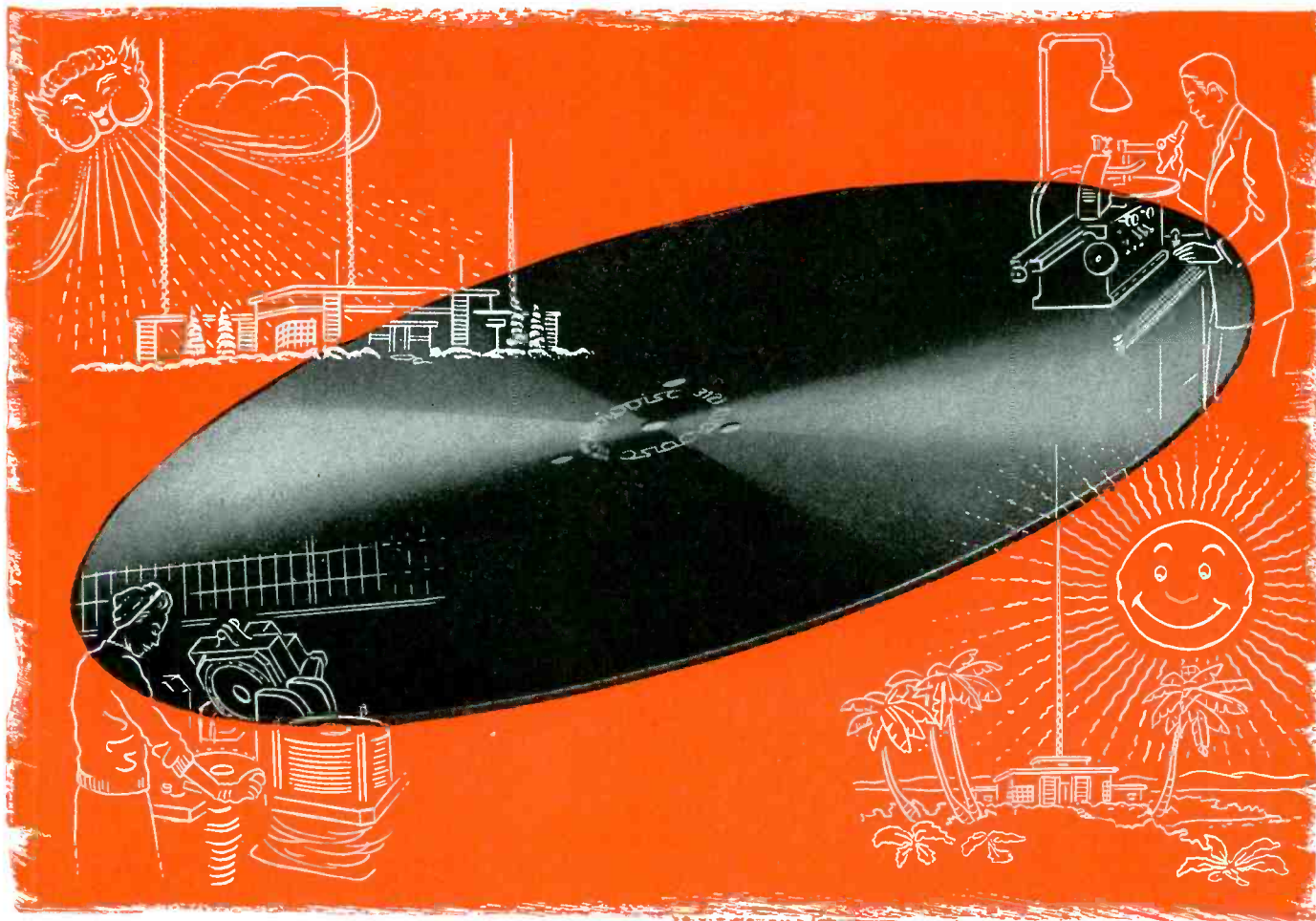

they speak for...

audiodiscs*

Audio Devices is continually receiving letters from broadcasting stations and recording studios giving unsolicited commendations on Audiodiscs. These come from all sizes of studios and from all climates in the United States and abroad. A few excerpts from typical letters recently received follow:

"AUDIODISCS have proven their worth at our station. We are for them one hundred percent." ...A 5,000 WATTER

"It may be of interest to you to know that for a long time we tried all makes of transcription blanks and long ago decided to use nothing but AUDIODISCS. We find them most satisfactory." ...A 1,000 WATTER

"It will interest you to know that we use only AUDIODISCS." ...A 10,000 WATTER

"We use AUDIODISCS exclusively and find them everything your research engineers have claimed." ...A RECORDING STUDIO

"We have found AUDIODISCS superior to any other disc tested, and consequently we have been using AUDIODISCS exclusively for quite some time." ...A 5,000 WATTER

"We have been users of AUDIODISCS since they were first produced by your company and have always found them satisfactory." ...A 50,000 WATTER

"We use AUDIODISCS exclusively when they are available. It is our experience that there is less drying effect in this climate, as well as less static trouble with AUDIODISCS than with other brands." ...A 5,000 WATTER

"In passing, I might say that we use Audio Red Label exclusively. AUDIODISCS are our favorite. We have found them to be uniformly satisfactory." ...A 1,000 WATTER

"Of all discs we have tried, AUDIODISCS are our standard and whenever supreme quality of reproduction of instantaneous recording is desired, it's AUDIODISCS for us." ...A RECORDING STUDIO

"We use AUDIODISCS exclusively and have been doing so for many years. After exhaustive tests we have found them hard to beat and we are pleased to mention this fact at this time." ...A 5,000 WATTER

"Our station has used AUDIODISCS practically exclusively since their introduction about ten years ago. Our recording engineers appreciate their high uniform quality." ...A 50,000 WATTER

"We have never used any other than AUDIODISCS except for a few times during the war when AUDIODISCS were not available." ...A 250 WATTER

AUDIO DEVICES, INC., 444 Madison Avenue, New York 22, N. Y.

Export Department: Rocke International Corp., 13 E. 40th Street, New York 16, N.Y.

Audiodiscs are manufactured in the U.S.A. under exclusive license from PYRAL, S.A.R.L., Paris

* REG. U.S. PAT. OFF.



they speak for themselves **audiodiscs**

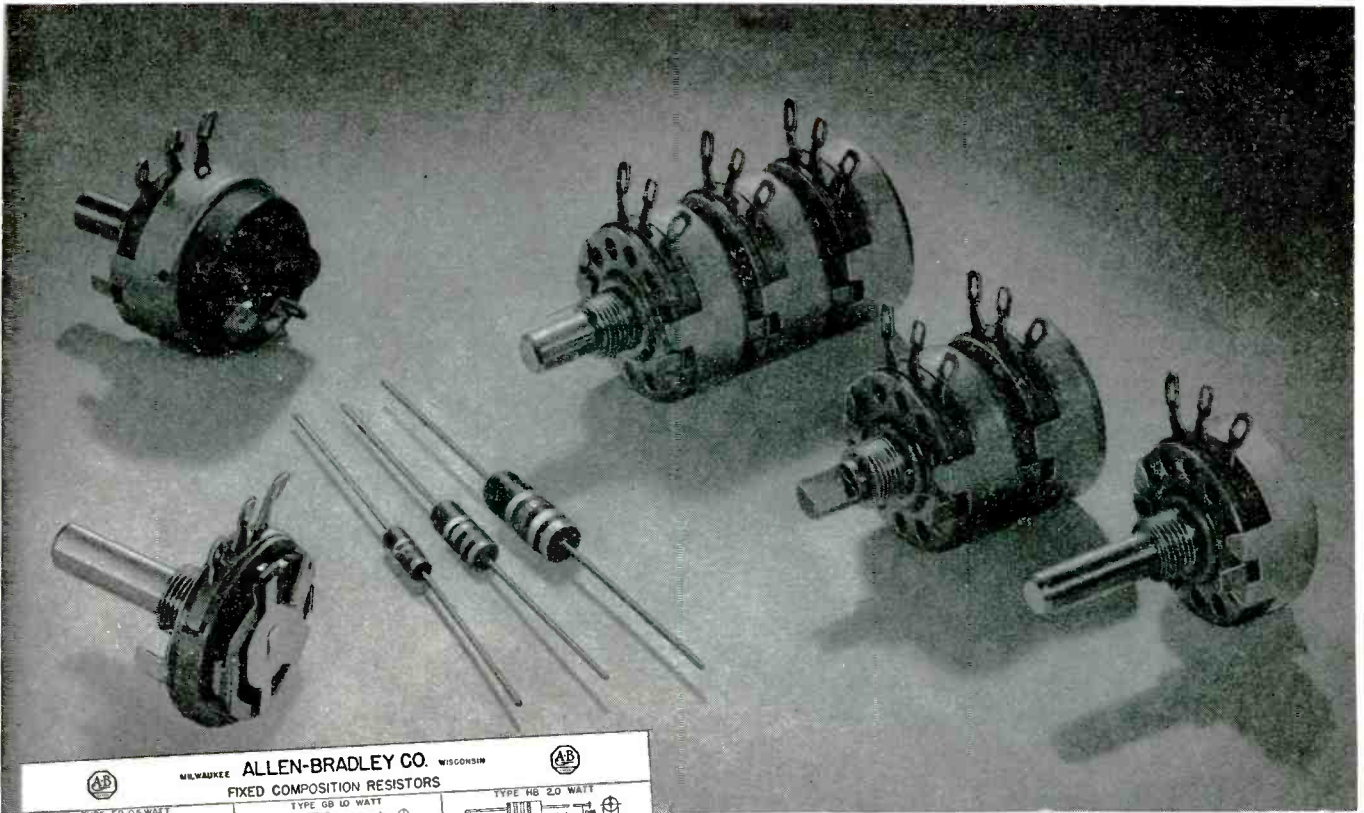

ALLEN-BRADLEY CO. WISCONSIN
MILWAUKEE

FIXED COMPOSITION RESISTORS

TYPE EB 0.5 WATT TYPE GB 10 WATT TYPE HB 2.0 WATT

MAX. CONTINUOUS RATING AT 70°C. MAX. 0.5 WATT OR 150 VOLTS MAX. CONTINUOUS RATING AT 70°C. MAX. 10 WATT OR 500 VOLTS MAX. CONTINUOUS RATING AT 70°C. MAX. 2.0 WATT OR 1000 VOLTS MAX.

ALL THE RESISTORS ABOVE ARE AVAILABLE AS STANDARD IN THE RMA. RESISTANCE VALUES AND TOLERANCES AS INDICATED BY ALLEN-BRADLEY PART NUMBERS IN THE FOLLOWING TABULATION. NOTE: CERTAIN VALUES ARE STANDARD ONLY IN 1% TOLERANCE OTHERS IN 5% AND 10%.

RESISTANCE VALUE	RESISTANCE TOLERANCE	WATTAGE	VOLTAGE	TEMPERATURE COEFFICIENT	TEMPERATURE RANGE	RESISTOR TYPE	RESISTOR CODE
10	±5%	0.5	150	±100 ppm/°C	-55 to +125	EB	10-5-150-100-100-100
10	±10%	0.5	150	±100 ppm/°C	-55 to +125	EB	10-5-150-100-100-100
10	±1%	0.5	150	±100 ppm/°C	-55 to +125	EB	10-5-150-100-100-100
10	±5%	10	500	±100 ppm/°C	-55 to +125	GB	10-10-500-100-100-100
10	±10%	10	500	±100 ppm/°C	-55 to +125	GB	10-10-500-100-100-100
10	±1%	10	500	±100 ppm/°C	-55 to +125	GB	10-10-500-100-100-100
10	±5%	2.0	1000	±100 ppm/°C	-55 to +125	HB	10-20-1000-100-100-100
10	±10%	2.0	1000	±100 ppm/°C	-55 to +125	HB	10-20-1000-100-100-100
10	±1%	2.0	1000	±100 ppm/°C	-55 to +125	HB	10-20-1000-100-100-100

ALLEN-BRADLEY SOLID MOLDED FIXED RESISTORS

SEND FOR THIS HANDY RESISTOR CHART

RESISTORS

for INDUSTRIAL ELECTRONIC APPLICATIONS

FIXED RESISTORS—Available in ½-watt, 1-watt, and 2-watt ratings from 10 ohms to 22 megohms in all RMA standard values. Will sustain an overload of ten times rating for several minutes without failing. The leads, tempered near the unit to prevent sharp bends, are easily soldered. Conveniently packed in honeycomb cartons that speed up your assembly line operations.

ADJUSTABLE RESISTORS—The Type J Bradleyometers are the only continuously adjustable composition resistors with a 2-watt rating and high safety factor. Solid molded element—not a film, paint, or spray type. A high-quality adjustable resistor that is ideal for important industrial, radar, and other electronic equipment. Stands up in severe service. Unaffected by heat, cold, moisture, or age.

Allen-Bradley Co., 110 W. Greenfield Ave., Milwaukee 4, Wis.

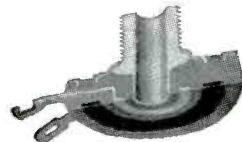

Type J Bradleyometer provides any Resistance-Rotation Curve

The resistor of the Type J Bradleyometer is a solid molded ring. During manufacture the resistor material is varied throughout the circumference of the molded ring to provide any desired resistance-rotation curve.

The resistor unit is molded as a one-piece ring with terminals, face plate, and threaded bushing imbedded in the ring. The contact between brush and resistor unit improves with age.

ALLEN-BRADLEY

---RESISTORS---RELAYS---



QUALITY

Dependable VHF Radio Reception

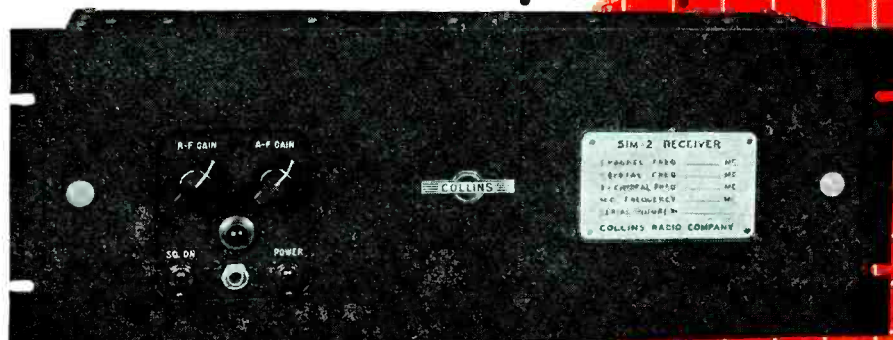

The Collins 51M-2
VHF Receiver

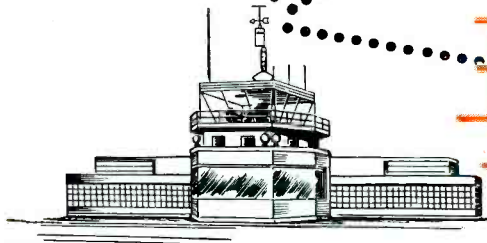

for Municipal Towers

Remote Operation

The many inherent advantages of very high frequency radio communication between control towers and aircraft can be realized with Collins equipment. The Collins 51M-2 VHF radio receiver for ground stations provides continuous, reliable reception on any one frequency between 118 megacycles and 136 megacycles. It can be installed in a remote location and left unattended, with all necessary control circuits and audio output connected by telephone line to the operator's position.

Million-to-One AVC Range

A carrier operated audio muting circuit is provided; thus background noises can be greatly

reduced during the absence of radio signals. The muting threshold is adjustable. Automatic volume control maintains an essentially constant audio output even though the strength of the r-f input signal varies over a million-to-one ratio.

No Spurious Responses

High sensitivity, signal to noise ratio, and rejection of spurious signals contribute to the superior performance. Use a 51M-2 for each frequency you wish to monitor. You can mount them all in a single cabinet and utilize a single antenna without interaction.

Let us send you an illustrated bulletin giving detailed specifications of this new receiver.

IN RADIO COMMUNICATIONS, IT'S . . .



COLLINS RADIO COMPANY, Cedar Rapids, Iowa

11 W. 42nd Street, New York 18, N. Y.

458 South Spring Street, Los Angeles 13, Calif.

KENYON T-LINE ADDITIONS

For Amateur and Industrial Use!



KEN-O-TAP UNIVERSAL DRIVER TRANSFORMERS

500 Ohm Line to any Class B Grids

Primary to Secondary Ratio Variable from 1:13.3 to 1: .7

Type	Power Rating	Case No.	Weight	List Price
T-261	7 Watts	3A	2¾ lbs.	\$ 9.70
T-262	18 Watts	4A	5¼ lbs.	13.20

Any Line or Single or Push Pull Plates to Class B Grids

Primary to ½ Secondary Ratio Variable from 7.0:1 to 1:9.0

Type	Audio Rating	Case M Size	Max. Pri. D.C.	Max. Sec. D.C.	Weight	List Price
T-264	7 Watts	3A	100 MA	100 MA	2¾ lbs.	\$ 9.95
T-263	18 Watts	4A	200 MA	200 MA	5¼ lbs.	15.25

FILAMENT TRANSFORMERS

Primary 115 Volts, 50 to 60 Cycles

Type	Sec. Rating	Insul. Test	Case No.	Weight	List Price
T-393	5/5.1/5.25 V. — 26 ACT	2000 V.	5A	9½ lbs.	\$17.30
T-394	5/5.1/5.25 V. — 32 ACT	2000 V.	5A	10½ lbs.	18.65
T-395	6.3 V. — 20 ACT	2000 V.	5A	9 lbs.	15.30
T-396	6.3 V. — 30 ACT	2000 V.	5½A	12 lbs.	21.00
T-397	6.3 V. — 12 ACT	2000 V.	4A	5¾ lbs.	10.90

PLATE TRANSFORMERS

Primary 115 Volt, 50 to 60 Cycles

Type	Primary Conn.	Secondary Volts		M.A. D.C.	Case No.	Weight	List Price
		D.C.	A.C.				
T-673	High	3000	3400-0-3400	400	10A	82 lbs.	\$110.00
	Low	2500	2840-0-2840	500			
T-674	High	3000	3400-0-3400	800	Special End Castings	135 lbs.	155.00
	Low	2500	2840-0-2840	1000			

These Units are designed for Continuous Duty on Low Voltage Taps at 85% of D.C. Current Rating.

REACTORS

Type	Inductance At Rated D.C.	Rated D.C. MA.	D.C. Resistance	Insul. Test	Case No.	Weight	List Price
T-180	10	500 MA.	60	7000 V.	8A	26¼ lbs.	\$43.00
T-181	5	1000 MA.	18	7000 V.	9A	50 lbs.	63.00
T-530	6/20	500/50 MA.	60	7000 V.	8A	26¼ lbs.	43.00
T-531	3/10	1000/100 MA.	18	7000 V.	9A	50 lbs.	63.00

KEN-O-TAP MODULATION TRANSFORMERS

Type	Audio W. Pri.	Class C W. Sec.	Max. Pri. D.C.	Max. Sec. D.C.	Max. D.C. Voltage	Primary Range Ohms	Sec. Range Ohms	Case No.	Weight	List Price
T-441	125	250	250 MA.	250 MA.	1500	2000-20000	200-20000	6A	15½ lbs.	\$25.20
T-442	600	1200	400 MA.	400 MA.	3000	500-18000	200-19000	9A	45 lbs.	67.50

YOUR INQUIRIES ARE INVITED. WRITE TODAY FOR FURTHER DETAILS.

KENYON TRANSFORMER CO., Inc. 840 BARRY STREET
NEW YORK 59, N.Y.

**I make a bond that's strong and fast
A metal joint that's bound to last**



**With many laboratory checks
And strict control I'm held to specs**



**With each re-order, pound or ton
My composition varies none**



SO WHAT?...

Just this... I'm a Federated solder... and that means my composition is identical whether I am shipped from San Francisco in June or from Chicago in December. Uniformity in the solder you use saves production headaches.

Federated can supply you *promptly* with the best in solders — acid core, rosin core, solid wire, bar, and body. For unusual applications *any* solder can be alloyed to your specific requirements. When you need him the friendly Federated service man is ready to answer your solder questions, or help you with any non-ferrous problem. Federated Metals Division, American Smelting and Refining Company, 120 Broadway, New York 5, New York.

JMLco F-11 28



Federated METALS DIVISION
AMERICAN SMELTING AND REFINING COMPANY

They're
Cost-Controlling
and "See-Worthy"

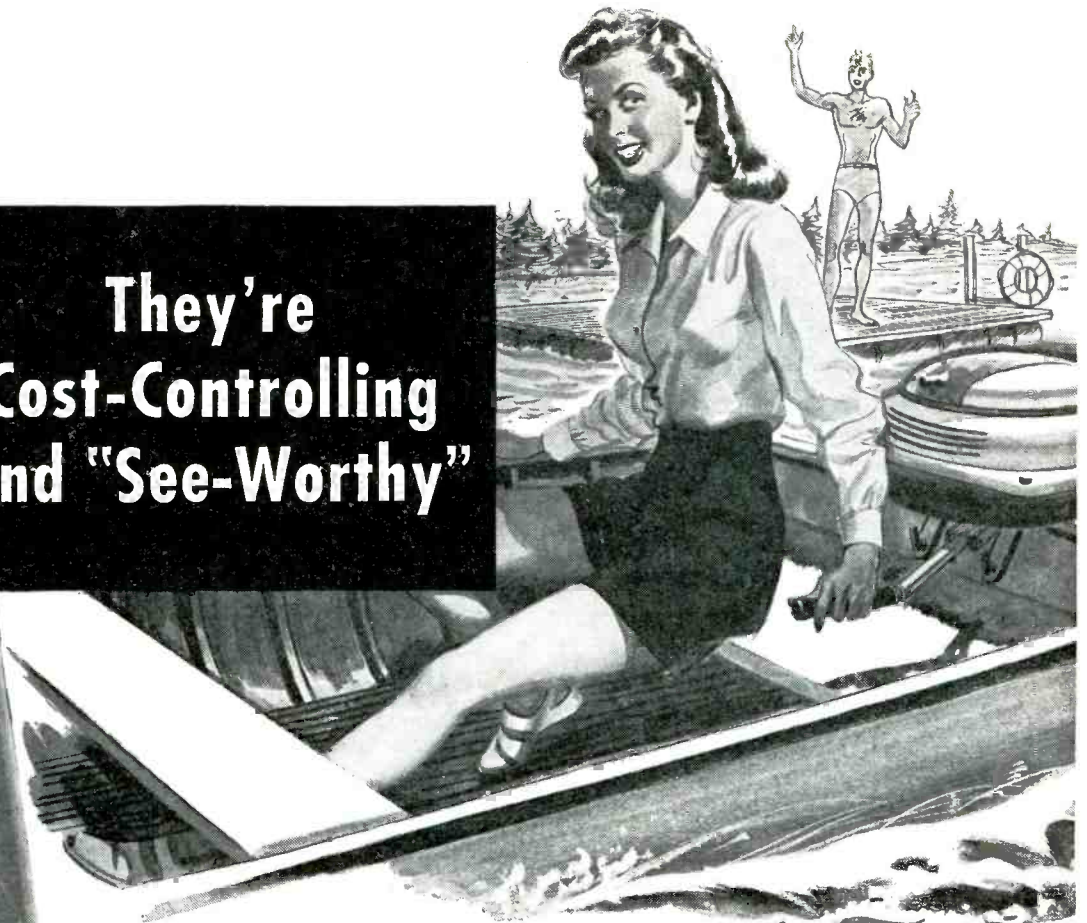

... that's why Outboard Motor Builders and Owners "go Overboard"
for **AMERICAN PHILLIPS SCREWS**

"MORE POWER TO YOU" IN PRODUCTION -- Assembly speeds skyrocket with fumble-proof, slip-proof, burr-proof and damage-proof American Phillips Screws — they're automatically straight to drive. Makers of motors, boats, planes, appliances, furniture, radios and other products who have set their sights for volume production and lower costs earn time-savings UP TO 50%.

"MORE POWER TO YOU" IN PROMOTION — In the showroom, American Phillips Screw-Fastened products have a sturdy, ship-shape, modern look. Everywhere the decorative, straight set heads of American Phillips Screws tell a sales story to the customer of quality workmanship and fastening that stays put! Is *your* product collecting on this *money-saving* and *money-making* combination of advantages? Write American for complete details.

AMERICAN SCREW COMPANY, PROVIDENCE 1, RHODE ISLAND
Chicago 11: 589 E. Illinois St. Detroit 2: 502 Stephenson Building

4-WINGED DRIVER CAN'T SLIP OUT
OF PHILLIPS TAPERED RECESS

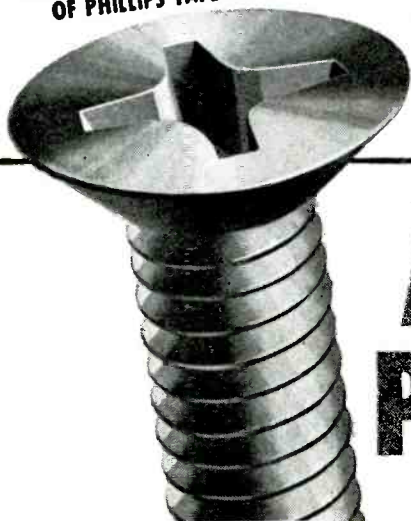

**AMERICAN
PHILLIPS** *Screws*



ALL TYPES
ALL METALS: Steel,
Brass, Bronze, Stain-
less Steel, Aluminum,
Monel, Everdur (sil-
icon bronze)

THORDARSON TRANSFORMERS

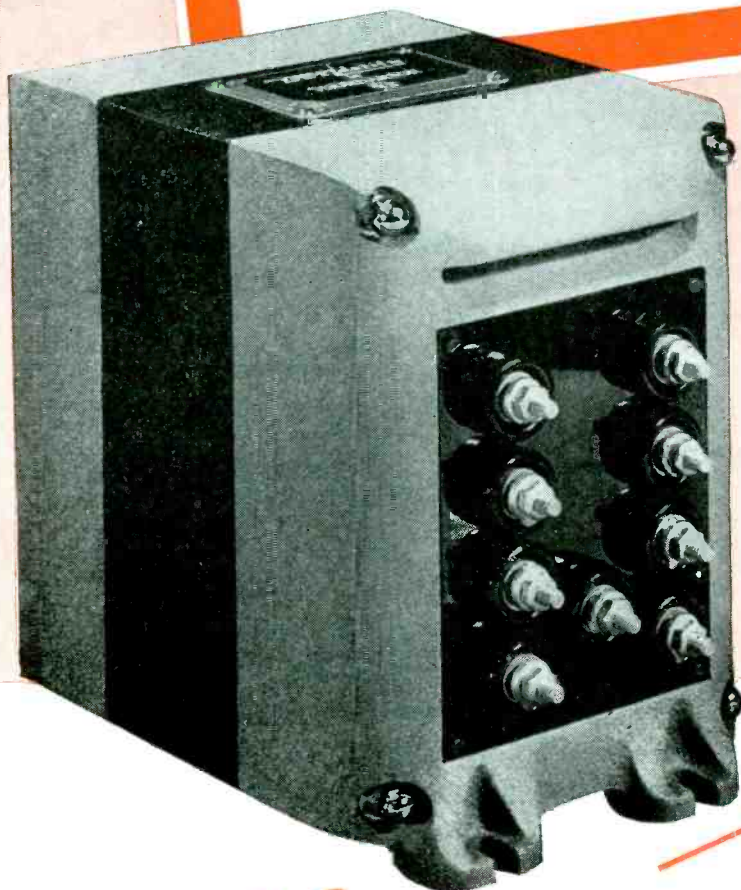

A GUARANTEE OF QUALITY PERFORMANCE FOR OVER HALF A CENTURY!

For over fifty years Thordarson has led the field in the development of fine transformer equipment. The first to build transformers for specific industrial applications, this company has also pioneered many improvements in manufacture, among them the superior coil and core materials used throughout its entire line. Thordarson's vigorous policy of research and development, together with an unusually high production standard, has made its name a guarantee of quality... an assurance of trouble-free performance among engineers everywhere.

Our technical staff is available to assist you with your transformer problems. We are especially equipped to handle those transformers which require a high degree of engineering skill and which must be manufactured to very rigid specifications. Send us full details as to your requirements today.

Thordarson

ELECTRONIC DISTRIBUTOR AND
INDUSTRIAL SALES DEPARTMENT

MAGUIRE INDUSTRIES, INCORPORATED
936 NORTH MICHIGAN AVE., CHICAGO 11, ILLINOIS
EXPORT ADDRESS • SCHEEL INTERNATIONAL, INC.
4237 NORTH LINCOLN AVE., CHICAGO 18, ILLINOIS
CABLE—HARSHEEL



"RAISED-LAY"*

The **NEW** material for
Electrical Bar Contacts

This new material consists of one or more strips of precious metal bonded to the base metal in the form of a ridge or bar.

This new method of lamination provides a great advantage to manufacturers of many contact assemblies, in that an arm or leaf can be blanked out with the contact already attached. The precious-metal ridge constitutes a bar-shaped contact.

By specifying the width and height of the precious-metal strip, any electrical current requirements can be met. Costly assembly operations are reduced to blanking costs. The precious metal that was wasted in the shank of a rivet can be saved.

We have standardized on a number of strip widths and thicknesses for both single, double and double-double combinations in "Raised-Lay." We are also prepared to furnish contact material in the form of "Inlay," "Edgelay," and "Overlay." In addition to supplying these materials, we offer a blanking service to your specifications.

Your inquiries are cordially invited.

*Patents applied for covering both the material and the method of manufacture.



START
RIGHT
with

D. E. MAKEPEACE COMPANY

Main Office and Plant, ATTLEBORO, MASSACHUSETTS

New York Office, 30 Church St.

Chicago Office, 55 East Washington St.

LAMINATED PRECIOUS METALS
SHEET • WIRE • TUBING
FABRICATED PARTS AND ASSEMBLIES
BAR CONTACT MATERIAL
PRECIOUS METAL SOLDERS

There's More to Spring Design than Spring Designing

Example: One of the bugaboos of capacitor motor design is to switch out the starting winding at the right time . . . not too soon else the motor will jockey between starting and running windings . . . not too late or the starting winding may burn out.

Ordinarily, a tendency to switch out at the wrong speed is not apprehended before the motor is tested, and at that stage can be costly in terms of assembly time. If you are a motor manufacturer you can eliminate the possibility of trouble by using Hunter springs, quality-controlled and color-coded to match variations in your centrifugal mechanisms.

The centrifugal mechanism is not merely a riddle in spring design. It is more accurately a matter of engineering strategy. Hunter, has, in addition to its spring designers, a separate complement of *electrical* and *mechanical* engineers. These men can be maneuvered quickly into position to aid spring designers. Hunter also brings to bear on your problem the only testing equipment of its kind, especially devised by the Hunter Special Apparatus Division for attaining *your* objective.

More information about this special service for motor makers (or anyone with a similar centrifugal application) is yours on request.

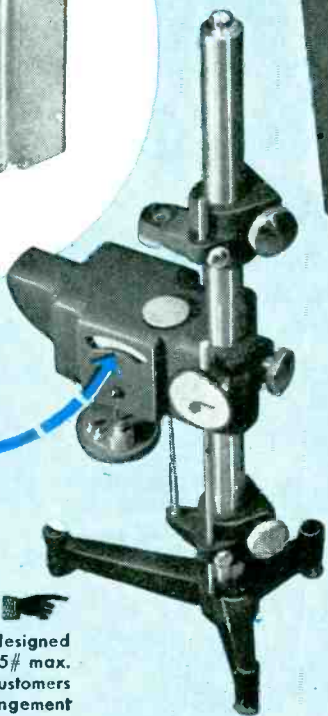
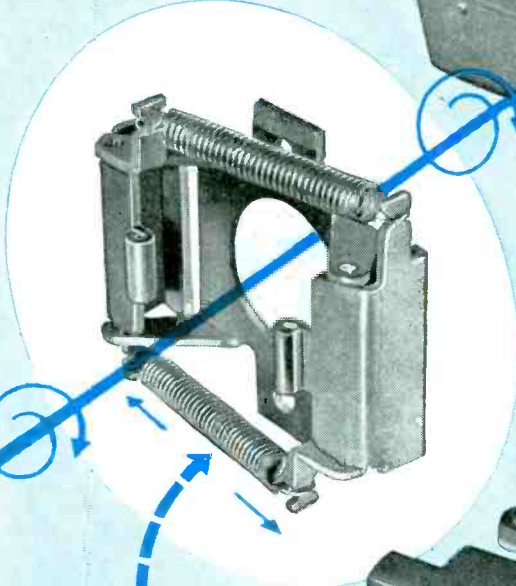
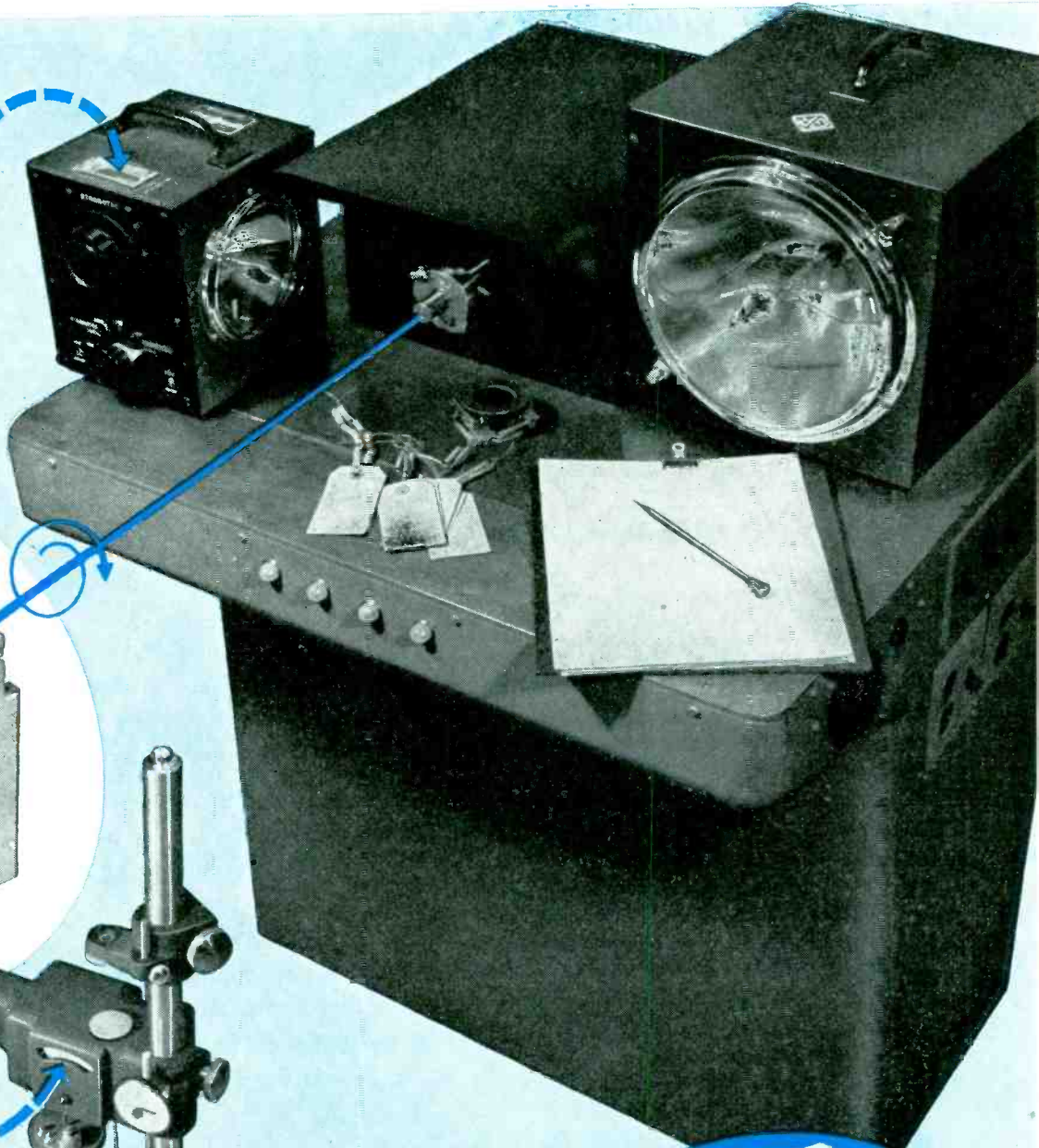
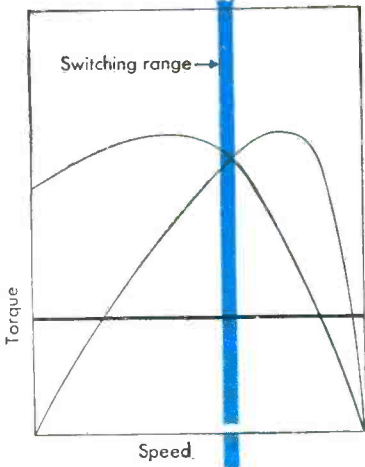

HUNTER PRESSED STEEL COMPANY
 LANSDALE, PENNSYLVANIA

Springs, Metal Stampings, Wire Forms, Mechanical and Electrical Assemblies

Now available, these Hunter designed and built Spring Load Testers (5# max. cap.) Supply limited to Hunter customers at present. Details of sales arrangement on request.

" We didn't know you
could do that with
Callite tube & lamp
components "



CALLITE'S "M" SHAPED FILAMENTS for high-power projection lamps. Employing a tungsten wire of .010" diameter wound on a .035 molybdenum mandrel for 55 turns per inch, its faster crystal growth produces interlacing crystals whose structure maintains the stability and non-warping property of the coil, thus withstanding elevated temperatures. Used for vacuum and incandescent lamps of high wattage and heat dissipation.



CALLITE'S CONE-SHAPED TUNGSTEN FILAMENT. This heater wire, .020" in diameter, is specially designed to produce lamp filaments that will maintain a constant lumen output because it permits very little distortion of the coils (despite their unusual pattern) during the life of the lamp. Used for special types of incandescent and gas filled lamps.



CALLITE'S COILED-COIL HEATER. Employs a .375 milligram tungsten wire heater wound on a .004 molybdenum mandrel for 800 turns per inch. The coil is then rewound on a .030 steel mandrel and skip turned every 68 t.p.i. Result: a highly efficient coiled-coil heater for miniature electron tubes with high emission properties equal in performance to larger envelope tubes.

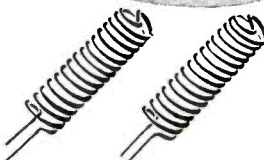

CALLITE'S MINIATURE DOUBLE HELICAL HEATER for radar and microwave transmitting tubes. This molybdenum-tungsten alloy filament, .0048" in diameter and 133 mm. in length, is coated with aluminum. Evenly wound, of high tensile strength, good ductility and uniform resistance, this filament is particularly adaptable for high and ultra-high frequencies in restricted spaces.

THE CALLITE COMPONENTS featured above indicate the kind of engineering ingenuity and production proficiency with which Callite serves the lamp and tube industry. For 26 years Callite has supplied standard and special shapes in every industry where lamp and tube components are used. The same ingenuity and flexibility of the Callite organization is at your command for any component problem requiring quick, efficient solution. Callite Tungsten Corporation, 544 Thirty-ninth St., Union City, N. J. Branch Offices: Chicago, Cleveland.



Callite

TUBE & LAMP COMPONENTS

Hard glass leads, welds, tungsten and molybdenum wire, rod and sheet, formed parts and other components for electron tubes and incandescent lamps.



write for
Catalog #156.

OVER 26 YEARS OF PIONEERING IN TUNGSTEN METALLURGY

this is the house . . .

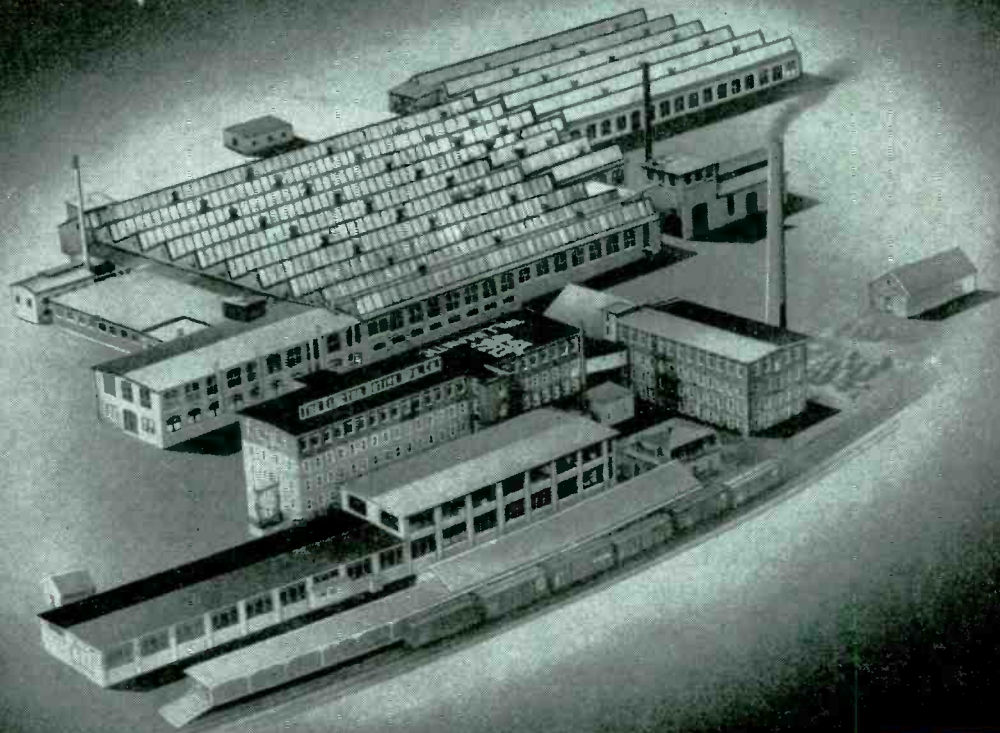

. . . that El-Menco built!

Size is not necessarily a sign of greatness. But when size is the result of consistently steady growth, based on an ever-widening demand for a product, then it is truly indicative of outstanding quality.

Year after year, in more and more instances, El-Menco Capacitors become first choice with manufacturers who are proud of their products.

Send for samples and complete specifications.

Foreign Radio and Electronic Manufacturers communicate direct with our Export Department at Willimantic, Conn., for information.

THE ELECTRO MOTIVE MFG. CO., Inc., Willimantic, Conn.



Write on firm letterhead
for samples and
catalog.



MOLDED MICA

El-Menco
CAPACITORS

MICA TRIMMER

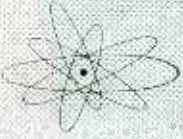

Designers

More energy storage per cubic inch



with these **NEW G-E**

DISCHARGE CAPACITORS

If you are trying to squeeze a lot of energy-storage capacity into a small space to reduce the size or weight of your equipment, General Electric's new Pyranol† discharge capacitors may be your answer. These new, smaller, lighter units give economical energy storage, fast discharge and service reliability.

Ambient temperature operating limits, at rated voltage, range from 0 to 50 C and the capacitance tolerances, measured at 25 C, are ± 10 per cent. The performance of these compact units has been thoroughly proved by several years of laboratory tests and actual operating experience in the field.

G-E light-duty energy-storage capacitors are particularly applicable to light-metal welding equipment and flash photography apparatus. Check the table below for ratings and dimensions of G-E discharge capacitors to fit your application . . . or mark Bulletin GEA-4646 on the coupon for more details. †Pyranol is G.E.'s nonflammable liquid dielectric.

PREFERRED RATINGS

D-C Voltage Rating	Muf	Watt-Seconds	Number of Bushings	Catalog Number	Height over Terminals $\pm \frac{1}{16}$ In.	Case Height $\pm \frac{1}{32}$ In.	Base Dimensions		Approximate Net Weight in Pounds
							$+ \frac{1}{8}, - \frac{1}{32}$ In.	$\pm \frac{1}{32}$ In.	
2000	25	50	*2	25F903	$5\frac{7}{8}$	$4\frac{1}{2}$	$3\frac{3}{4}$	$4\frac{9}{16}$	5.2
2000	28	56	*2	25F939	$5\frac{1}{4}$	$4\frac{3}{4}$	$3\frac{3}{4}$	$4\frac{9}{16}$	5.3
2000	40	80	1	25F910	$8\frac{1}{4}$	7	$3\frac{3}{4}$	$4\frac{9}{16}$	7.8
2500	25.5	80	1	25F911	$8\frac{1}{4}$	7	$3\frac{3}{4}$	$4\frac{9}{16}$	7.8
3000	60	270	2	14F312	$15\frac{1}{8}$	$13\frac{1}{8}$	4	8	26
3350	17.8	100	1	25F912	$8\frac{1}{4}$	7	$3\frac{3}{4}$	$4\frac{9}{16}$	7.8
4000	25/50	200/400	3	14F309	$15\frac{1}{8}$	$13\frac{1}{8}$	4	8	26
4000	100	800	2	14F311	$15\frac{1}{8}$	$12\frac{7}{8}$	$5\frac{1}{8}$	$13\frac{1}{2}$	56
4000	12.5	100	1	26F906	$6\frac{3}{4}$	$5\frac{1}{2}$	$3\frac{3}{4}$	$4\frac{9}{16}$	6
5000	25/50	313/625	3	14F305	$15\frac{1}{8}$	$13\frac{1}{8}$	$4\frac{1}{8}$	$13\frac{1}{2}$	46
6000	55	990	2	14F313	$16\frac{5}{16}$	$12\frac{7}{8}$	$5\frac{1}{8}$	$12\frac{1}{2}$	56
6000	25	450	2	14F314	$16\frac{5}{16}$	$13\frac{1}{8}$	4	8	26

* Cup-type bushings with solder lug terminals.

TWO NEW MOUNTINGS FOR GENERAL-PURPOSE RELAY

Two new mounting arrangements, this "plug-in" design and a "back-connected" design, have been added to General Electric's line of CR2790-E magnetic relays. These two new forms, plus the open and enclosed forms, make this general-purpose 10-amp relay useful in a wide variety of electronic applications.



Three contact arrangements—single-pole, single-throw; double-pole, single-throw; double-pole, double-throw—provide further design flexibility. Heavy silver contacts are rated 10 amps continuous at 115/230 volts, 60 cycles, and will safely close on 45 amps and open on 20 amps maximum. Check Bulletin GEA-4668 below for further details.

REMOTE POSITIONS THAT ARE ACCURATE

Here's a war baby that you can use. It's General Electric's d-c selsyn position-indicating equipment perfected for use in military aircraft. Transmitters will operate in ambient temperatures from -85 F to 158 F and are weather resistant. Indicators are available in two standard sizes: $1\frac{1}{8}$ -inch dial with 1 or 2 pointers, and $2\frac{3}{4}$ -inch dial with 1, 2, 3 or 4 pointers. Dial markings to meet your needs

GENERAL ELECTRIC



Digest

TIMELY HIGHLIGHTS ON G-E COMPONENTS

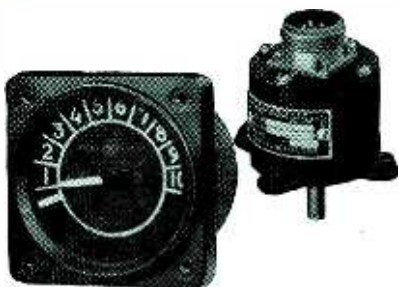

A single d-c selsyn indicating system consumes about 2 watts at either 12 or 24 volts. Any reasonable lead length may be used. Two indicating instruments can be operated from the same transmitter. Bulletin GET-1304 is a comprehensive application manual you'll find extremely helpful. Check it on the coupon.

COILS TESTED FAST ... INDUCTIVELY

High-speed production testing of small coils is possible with this General Electric low-voltage tester which shows the presence of short-circuited turns in unmounted coils and gives an approximate indication of the number of short-circuited turns. The coil to be tested is simply slipped over the core which projects from the top of the case; the coil's leads need not be connected.



This tester was designed for manufacturers who want accurate tests of coils before assembly in

small motors, relays, radios, transformers, instruments and other equipment. It is simple to operate, and connects to any 115-volt, 60-cycle supply. More information on this and another equipment for high-potential coil testing is included in Bulletin GEA-4539 . . . check it on the coupon below.

PRECISION RECTIFIER IN A SMALL PACKAGE

These new, small a-c to d-c power supplies are specially built for precision work with cathode-ray tubes, television camera tubes, radar indicator scopes, electron microscopes . . . or any job where good regulation, light weight and small size are primary considerations. These hermetically sealed, oil-filled power supplies will furnish up to 7 kv at 0.1 ma. They have a regulation of 3.5% per 0.1 ma d-c output, or better.



They easily meet Army and Navy specifications both in design and ability to withstand mechanical shock and operate continuously for long periods of time. Designed to

operate in ambient temperatures from -40°C to $+60^{\circ}\text{C}$. For quotation and further data, write General Electric Co., Section 642-15, Schenectady 5, N. Y., giving complete information on application proposed and specifications required.

25 G's WON'T BOTHER THIS SWITCHETTE

Shock, vibration, humidity and heat are all taken in stride by General Electric's tiny, light-weight Switchette. It is built to operate in ambient temperatures from 200°F to -70°F , and is tested at 95% relative humidity. Low-inertia moving parts, high contact force, and



double-break contact structure make it unusually resistant to vibration. Phenolic-resin operating button assures safety from live parts during operation.

The snap-action contact construction gives the Switchette a high current rating. Because of negligible contact bounce and lightness of moving parts, it is particularly well suited to application on electronic equipment. Bulletins GEA-3818 and GEA-4259 give electrical and mechanical details; check coupon below.

GENERAL ELECTRIC COMPANY, Sec. D 642-15
Apparatus Department, Schenectady 5, N. Y.

Please send me:

.....GEA-4646 (Discharge capacitors)GET-1304 (Position indicators)
.....GEA-4668 (Magnetic relays)GEA-3818 } (Switchettes)
.....GEA-4539 (Coil testers)GEA-4259 }

NOTE: More data available in Sweets' File for Product Designers

Name.....
Company.....
Address.....
City..... State.....

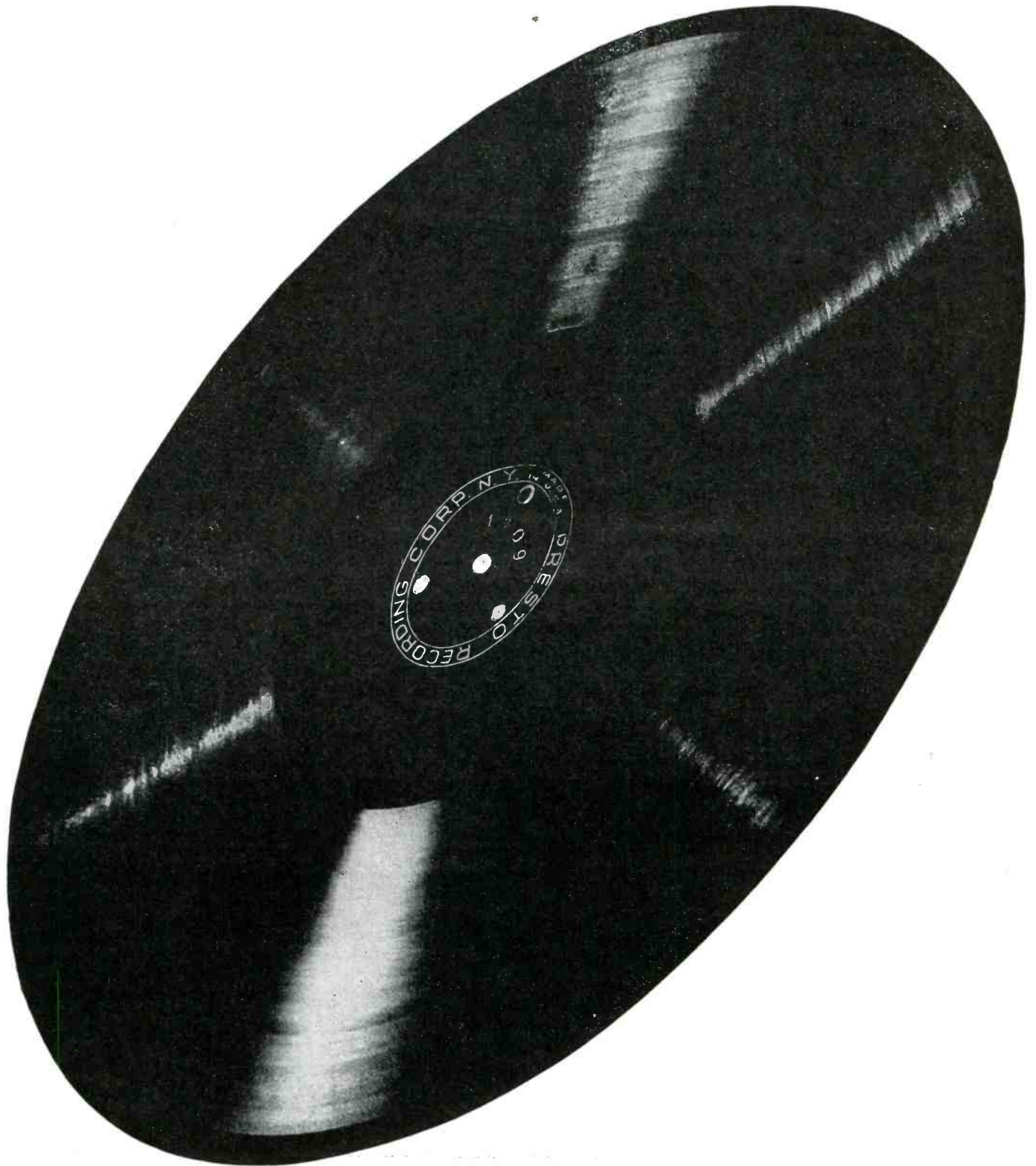

For true to life recording there has never been anything better than Presto Green Label Discs.



RECORDING CORPORATION • 242 WEST 55TH STREET • NEW YORK 19, N. Y.

Walter P. Downs, Ltd., in Canada

World's Largest Manufacturer of Instantaneous Sound Recording Equipment & Discs

From Elemental Fluorine...

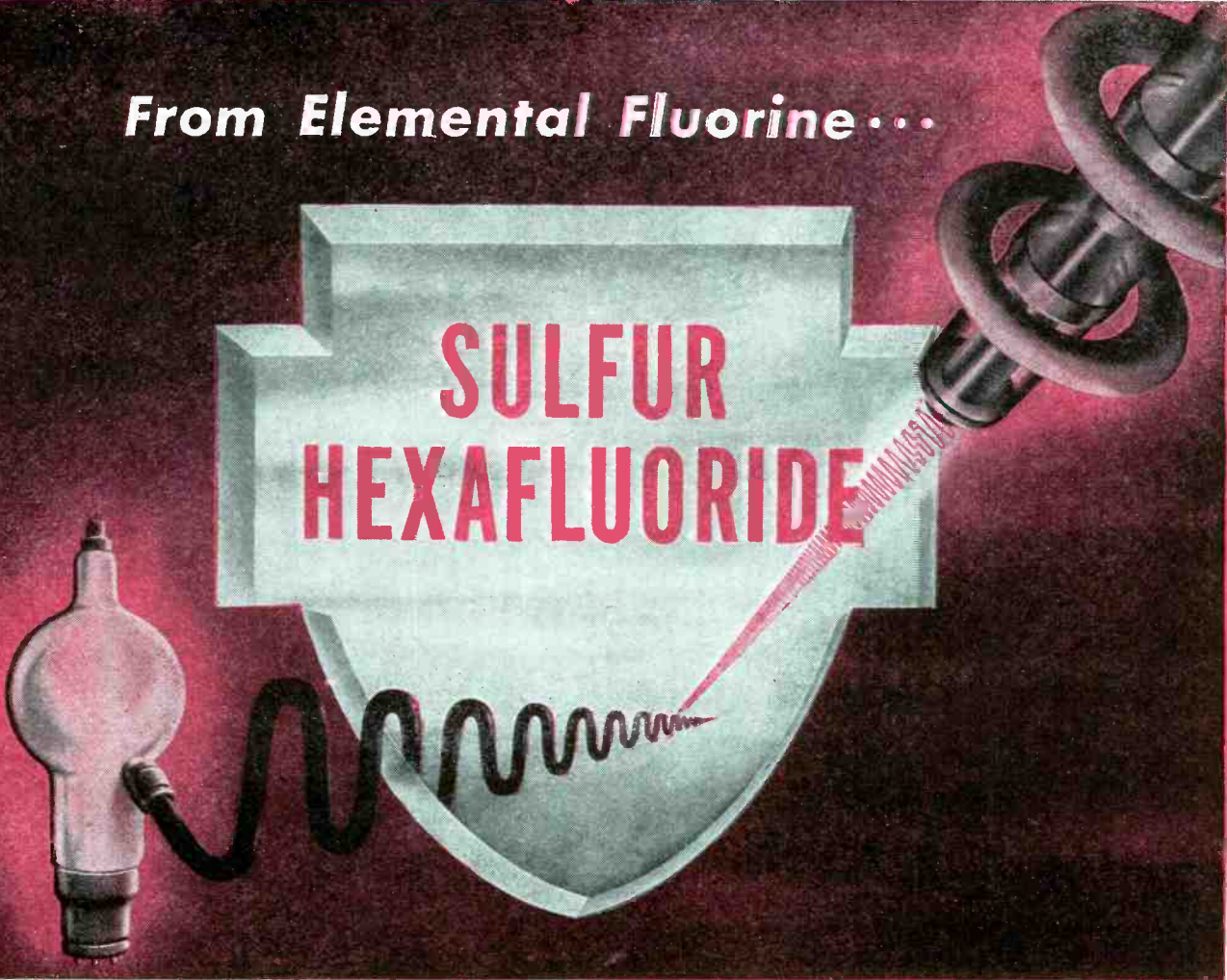

SULFUR HEXAFLUORIDE

A General Chemical Research Development +

SULFUR HEXAFLUORIDE

Formula: SF_6
Molecular Weight: 146.06
Melting Point: $-50.8^\circ C$
Sublimation Temperature: $-63.8^\circ C$
Critical Temperature: $45.6^\circ C$
Critical Pressure: 540 p.s.i.a.
Vapor Pressure:

Temp. ($^\circ C$)	Pressure (p.s.i.a.)
-80	5
-50	34
-20	102
+10	240
+40	481

In Sulfur Hexafluoride, General Chemical Research makes another important contribution to fluorine chemistry. This stable dielectric gas is the first commercial chemical produced from elemental fluorine to be offered Industry... and fore-runner of many similarly-made fluorine compounds awaiting introduction.

Sulfur Hexafluoride was discovered by Moissan and Lebeau in 1900 as the product of combustion of sulfur in fluorine. It has been found to be remarkably inert and to possess exceptional thermal stability. These characteristics,

together with its splendid electrical properties, have led to its present use as a gaseous dielectric in high-voltage equipment.

The physical data presented here may suggest other applications worthy of prompt investigation for your products and processes. For commercial quantities, experimental samples, or more detailed technical information, contact General Chemical Company, Research & Development Division, 40 Rector Street, New York 6, N. Y. Please use business letterhead when writing.

BASIC CHEMICALS



FOR AMERICAN INDUSTRY

GENERAL CHEMICAL COMPANY

40 Rector Street, New York 6, N. Y.

Sales and Technical Service Offices Serving Industry from Coast to Coast

In Canada: The Nichols Chemical Company, Limited, Sun Life Building, Montreal, Quebec

Siamese Twin Resistor

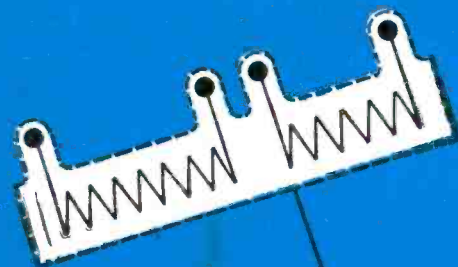

SAVES 40%

IN TELEVISION SET ASSEMBLY COST

DESIGN

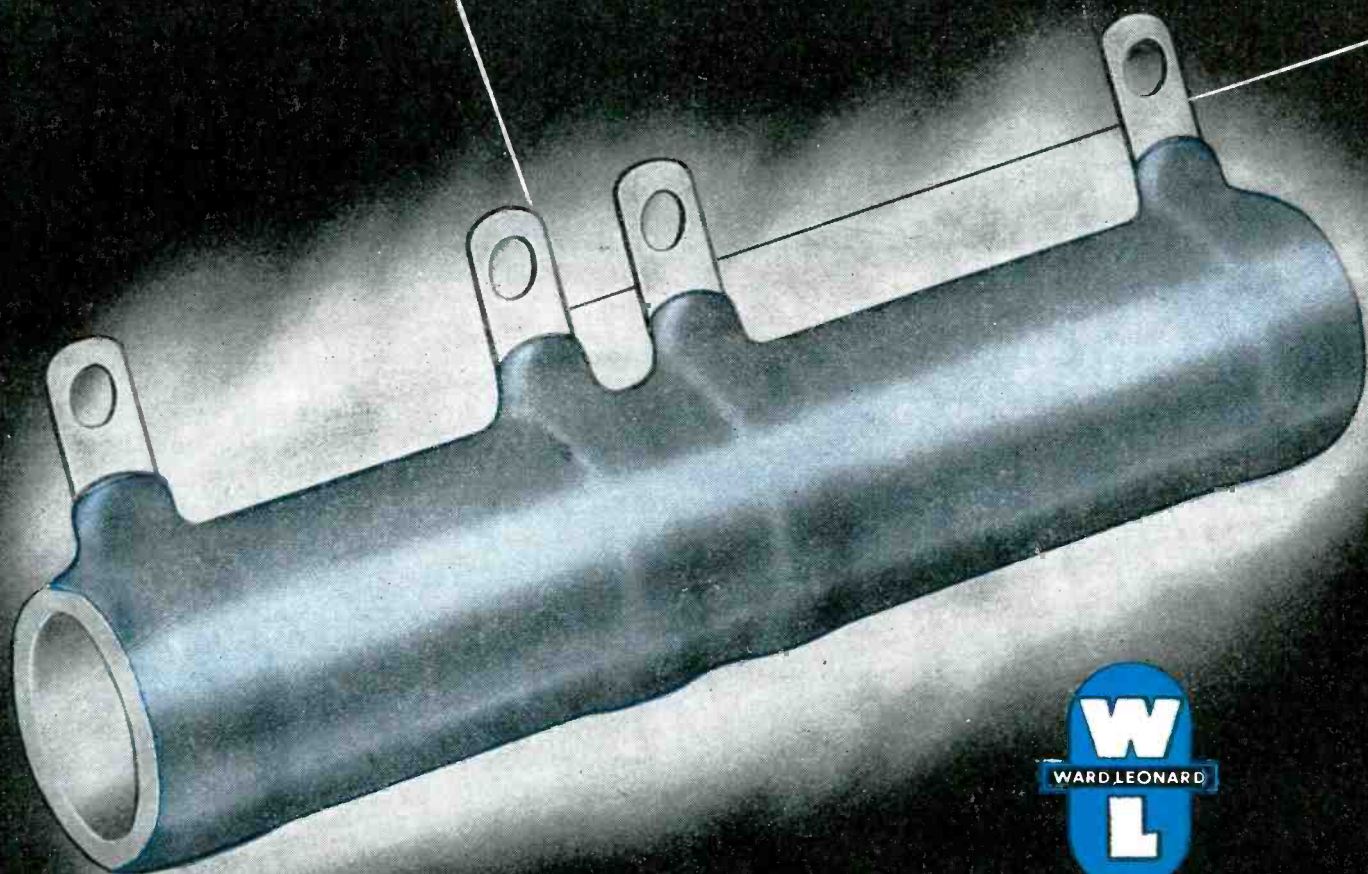

WARD LEONARD ELECTRIC CO.

Where Basic Designs in Electric Controls

In a television receiver circuit, two power wound resistors were needed, but the space for mounting them was hard to find.

So Ward Leonard suggested: instead of two separate resistors, each requiring individual mounting and installation, let's make a single Vitrohm unit with two *electrically independent* resistance windings. This unit is mounted just like any single resistor.

RESULT: less space needed . . . assembly cost cut 40%!



FOR YOUR PRODUCT'S
FASTER ASSEMBLY...
OR BETTER PERFORMANCE—
PUT THE PROBLEM THROUGH

Result - **E**ngineering

As this case shows, it often happens that by a slight modification of a basic design or by use of a certain manufacturing method, Ward Leonard can give you the *exact* result you need—without the extra cost of a *special* design.

Before you decide to “make the best” of a “standard” component, or pay a premium for a “special”, submit the problem to Ward Leonard. At no obligation, see if “Result-Engineering” can't work out the solution for you.

Blue means “Result-Engineering” in resistors, rheostats, relays and other electric controls. The distinctive blue identifies Ward Leonard “Result-Engineering”

FREE BULLETINS ON “Result-Engineered” Resistors. (Please request on business letterhead, mentioning your title.) WARD LEONARD ELECTRIC CO., Mount Vernon, New York. Offices in principal cities of U. S. and Canada.



**CRAZELESS ENAMEL
CHASES HEAT**

VITROHM Resistors are processed with a special vitreous enamel of Ward Leonard's own manufacture. VITROHM—tough, hard, moisture and acid resisting—fuses tightly to base (a) terminal connection (b) and wire (c) providing a medium (d) for quickly dissipating heat and protecting the resistance element.

Result: wire and surface temperatures maintained within close range.

RESISTORS • RHEOSTATS
RELAYS • CONTROL DEVICES

are **R**esult-**E**ngineered for You

KEEPING X-RAYS WHERE THEY BELONG

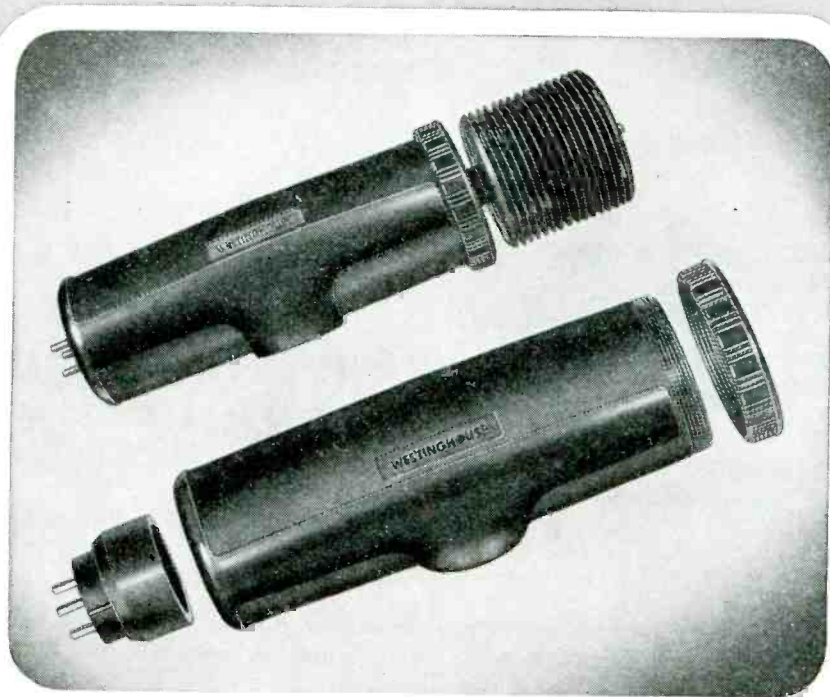

X-ray apparatus is afforded a maximum of safety and flexibility with this ray-proof plastic housing molded by Shaw. It consists of three molded pieces, integrated to form a structure of great strength and durability. The plastic used was Bakelite XM-7436, a material which combines opacity to X-rays and high voltage insulation properties.

On all plastics applications involving

special functional problems, Shaw's experience assures you of the right selection of materials and correct molding methods. With Shaw, you have behind you a skilled technical staff and a plant equipped to cope intelligently and imaginatively with the most complicated plastics assignments. This means top performance for your product and a maximum of economy in making it.



SHAW INSULATOR COMPANY

MOLDERS  SINCE 1892
160 COIT STREET IRVINGTON 11, N. J.

PLASTICS LITERATURE AVAILABLE

Shaw engineers have prepared a variety of literature, study of which might help you to a decision. Simply write a note about what phases of plastics especially interest you.

Or, you may prefer at once to call in a Shaw engineer, and present your problems for his study. This company's fifty-five years of plastics experience gives him a rich background from which you can draw.

Between the resources of Shaw and the Plax Corporation, Hartford 5, Conn., you can obtain assistance in almost all plastics methods and materials.

REGAL BUT ECONOMICAL PACKAGING



Products packaged in Plax Polyflex* Sheet are displayed in a setting that can't be matched for smart, crisp, distinctive simplicity—and for low cost.

Plax Polyflex Sheet can be adapted to standard packaging methods, and it is ideally suited to display. Free of discoloration, its natural brilliance is not affected by exposure to light or temperature change.

Inherently strong and flexible, it retains its freshness under normal handling and storage conditions.

Here is a versatility that package designers can use to good advantage, in protecting, presenting and displaying products. Here is packaging material that makes a product gleam in the customer's eye. Write Plax for complete details.

*U.S. REG. U.S. PAT. OFF.

WRITE FOR THIS POLYSTYRENE DATA

How to Machine Plax Polystyrene Products.
How to Use Coolants with Plax Polystyrene Products.
How to Cement Plax Polystyrene Products.
How to Polish Plax Polystyrene Products.
Notes on Design and Assembly of Plax Polystyrene Products.
Die-cut Parts from Plax Polystyrene.
How to Form Plax Polystyrene Rod.

AND THIS PRODUCT INFORMATION

Data Sheets on Plax Cellulose Acetate, Cellulose Acetate Butyrate, Methacrylate, Polyethylene, Polystyrene and Ethyl Cellulose Products.
Article on Plax's Blown Products.
New special plastic shapes by Plax.



133 WALNUT STREET ★ HARTFORD 5, CONNECTICUT

MAKING TUBES IS EASY..

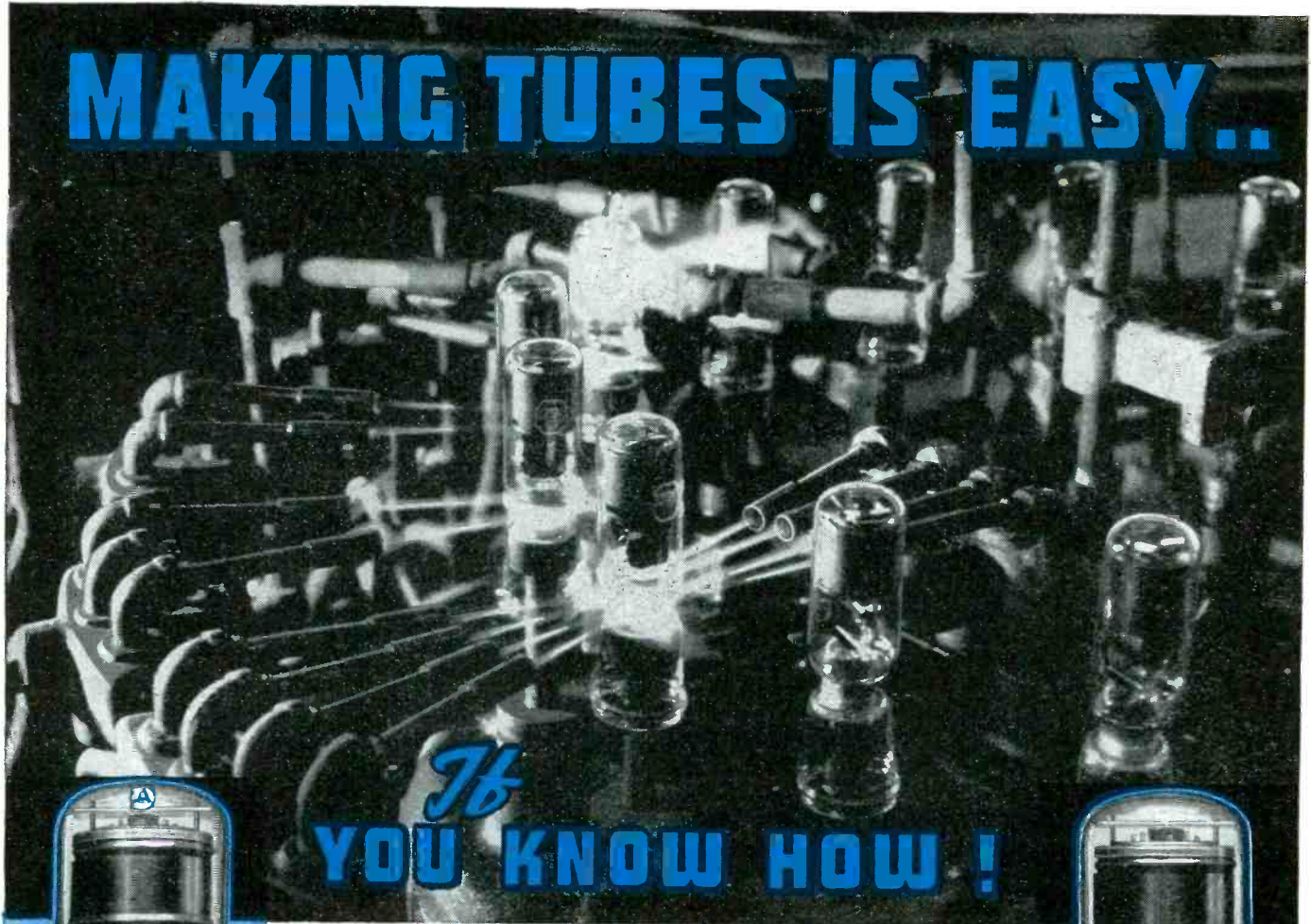

Hy
YOU KNOW HOW!

GLASS—FLAME—SEAL

Glass — flame — seal. Sounds easy. Just slip a glass bulb down over the mount assembly. Then by cleverly directed gas flames seal bulb and stem flare together.

Yes, there is a catch in it. A directed flame applied to glass may cause severe thermal shock. Local expansion and contraction then result in strain or fracture. Such thermal shock must be avoided by gradually raising the temperatures of both bulb and stem before hitting them with intensely hot flames. Without scientific control, permanent strains would be set up which might cause cracks — immediately or at some future time. The finished tube would become an "air leaker" and useless.

As this multihead rotary sealing machine indexes, fingers of gas flame — mixed with air delicately proportioned to achieve the proper temperature — warm, shape, and seal bulb to flare. Because it is shielded from the flames by the bulb, the stem is preheated before loading. This preheat temperature is maintained throughout sealing by hot air blown up under the flare. The continual stream of hot air also shapes the seal. Concentrated flames cut off the bulb cullet. In high speed operations, the sealing and subsequent exhaust operations are performed on the same machine.

A precision machine carefully controlled by the glass expert makes this working with glass easy. Gives you a combination which assures you once again of trouble-free performance from your Hytron tubes.

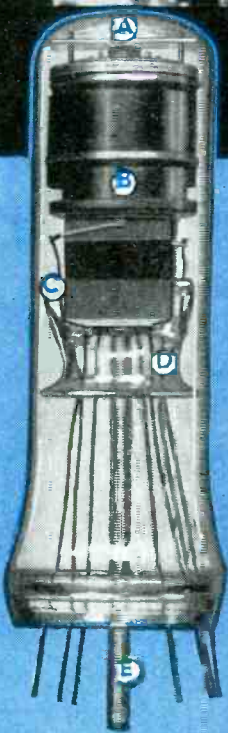

- A Outer bulb
- B Mount
- C Stem
- D Flare
- E Exhaust tube

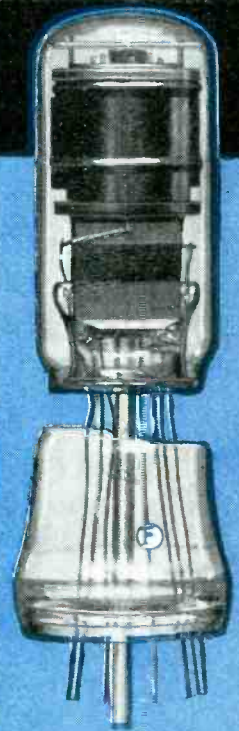

Sealed-in mount ready for exhaust. Cullet (F) cut off by gas flames is discarded.

SPECIALISTS IN RADIO RECEIVING TUBES SINCE 1921

HYTRON

RADIO AND ELECTRONICS CORP.

MAIN OFFICE: SALEM, MASSACHUSETTS



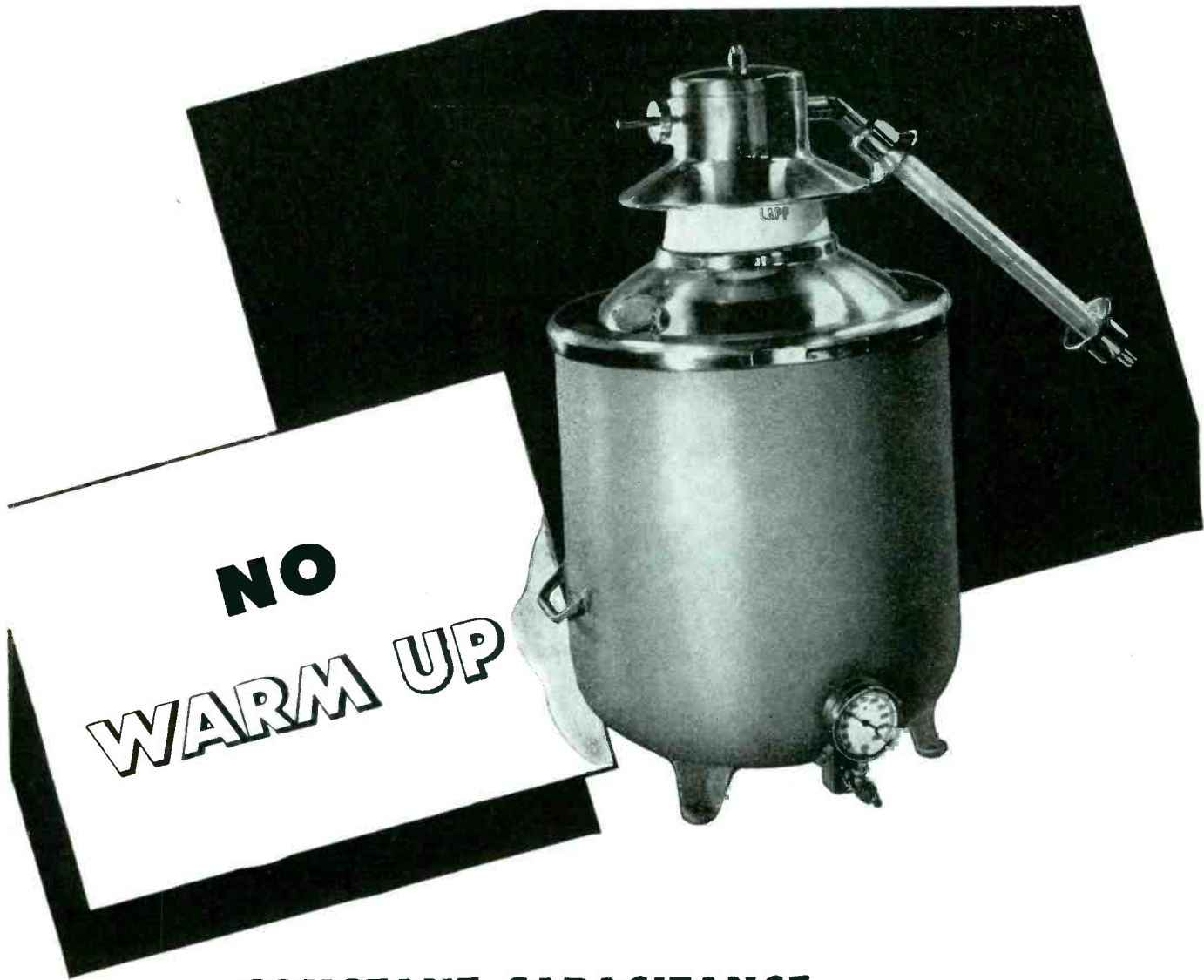

CONSTANT CAPACITANCE GAS-FILLED CONDENSERS...

As easy to tune as your home receiver, and once set, this gas-filled Lapp Condenser holds its capacitance under all conditions. No "warm up" required, no change in capacitance with change in temperature. As lump capacitance for service at high voltage and high currents, these gas-filled units save space, save power, and save trouble. Available in variable, adjustable, and fixed capacitance units. Condensers now in service range up to 60,000 mmf. (fixed), 16,000 mmf. (variable and adjustable). Current ratings to 500 amperes R.M.S., and voltage ratings to 60 Kv peak.

Lapp

LAPP INSULATOR COMPANY, INC., LE ROY, NEW YORK

Graphite Tube Anodes Handle

UP TO **300%** MORE POWER

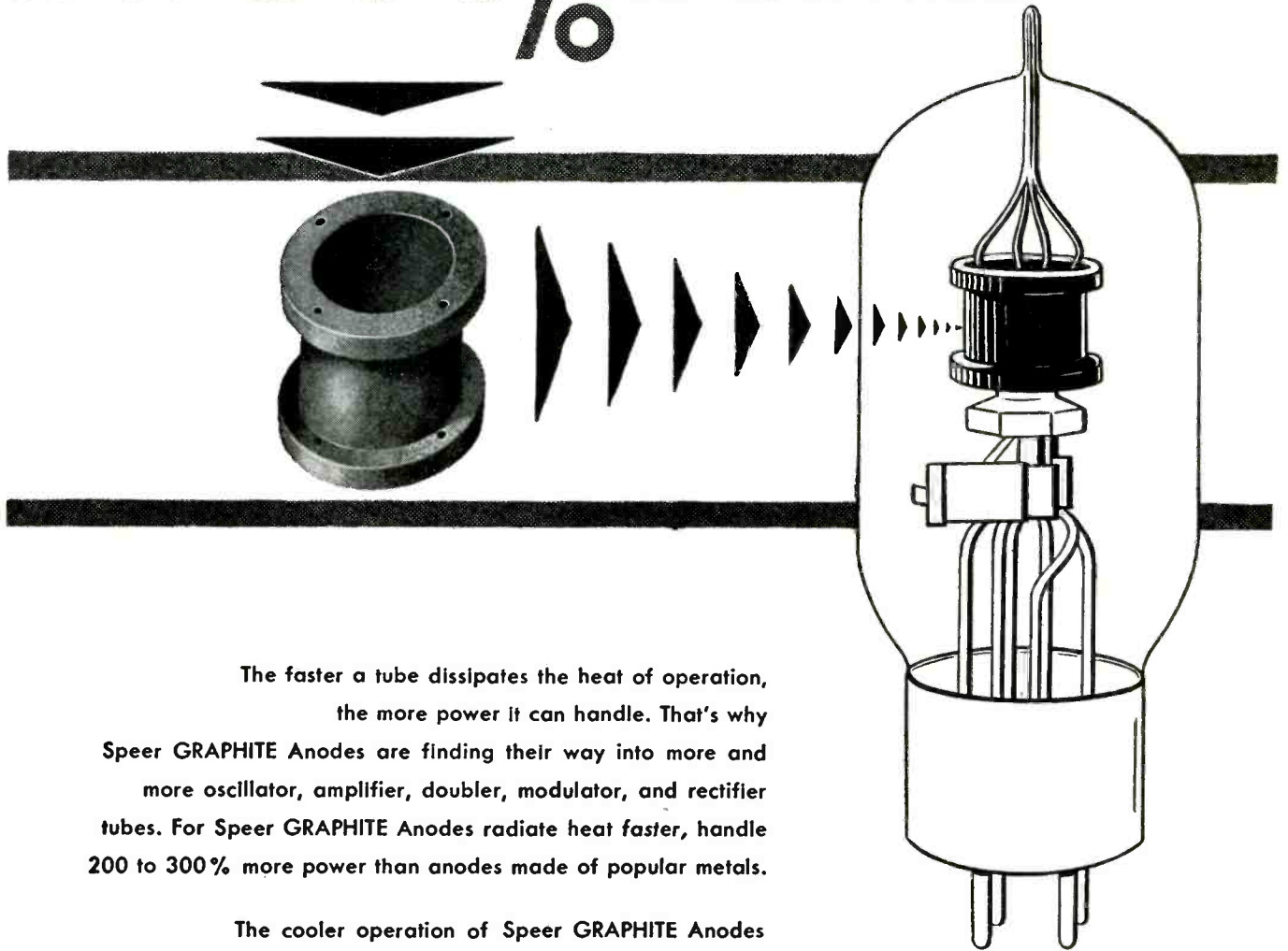

The faster a tube dissipates the heat of operation, the more power it can handle. That's why Speer GRAPHITE Anodes are finding their way into more and more oscillator, amplifier, doubler, modulator, and rectifier tubes. For Speer GRAPHITE Anodes radiate heat faster, handle 200 to 300% more power than anodes made of popular metals.

The cooler operation of Speer GRAPHITE Anodes means less heating and longer life for associated tube parts, too—reduced grid emissivity. Low frequency-drift comes along as another advantage still: non-warping graphite anodes maintain their characteristics, assure stability of inter-electrode capacitances in the tube.

Look to Speer Graphite Anodes when you're looking for better tubes.

Speer
CARBON COMPANY
ST. MARYS, PENNA.

brushes • contacts • welding electrodes • graphite anodes • rheostat discs • packing rings • carbon parts
CHICAGO • CLEVELAND • DETROIT • MILWAUKEE • NEW YORK • PITTSBURGH

PANEL INSTRUMENTS

A-C or D-C
Audio or Radio Frequency
(2½" • 3½" • 4½")

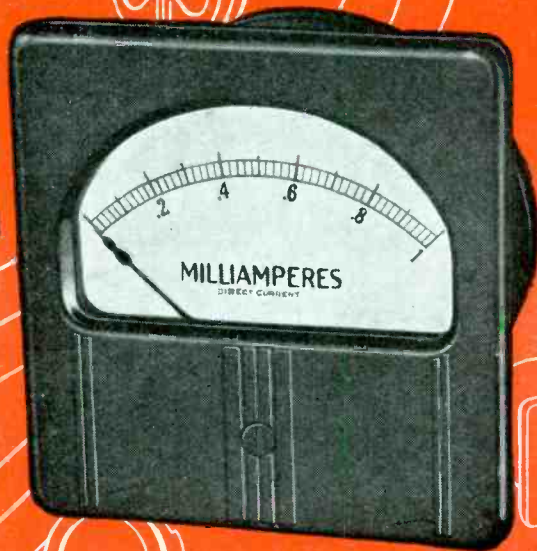

Immediate Delivery!

Here's wonderful news! A wide variety of standard ratings of Westinghouse panel instruments . . . now available for immediate delivery . . . all you need *when* you want them!

There's a complete selection . . . 2½", 3½" and 4½" sizes . . . rectangular and round cases, both with flush or projection-type mountings . . . for d-c, power frequency, audio frequency and radio frequency measurements.

Westinghouse panel instruments meet the highest standards of performance in every field of application. They have been proved in every industry and military requirement—on land, sea and in the air. You don't need to experiment.

The chassis design of Westinghouse instruments permits the final assembly of stocked and pretested subassemblies . . . to meet your requirements without delay. Every instrument is "accuracy checked" the day of shipment.

Whether you need thousands of electrical instruments or just one, Westinghouse has the production facilities and a nationwide service organization to *follow through*. Consult a Westinghouse instrument specialist. Call your nearest Westinghouse office or write Westinghouse Electric Corp., P. O. Box 868, Pittsburgh 30, Pa.

Send for the Westinghouse Instrument Booklet, B-3013-E9.

J-40359



Westinghouse INSTRUMENTS
PLANTS IN 25 CITIES . . . OFFICES EVERYWHERE

Built for Unfailing Performance

PRECISION PRECISION PRECISION

...IN TRIPLICATE!

In Material Development . . . In Mold Construction . . . In Plastic Processing

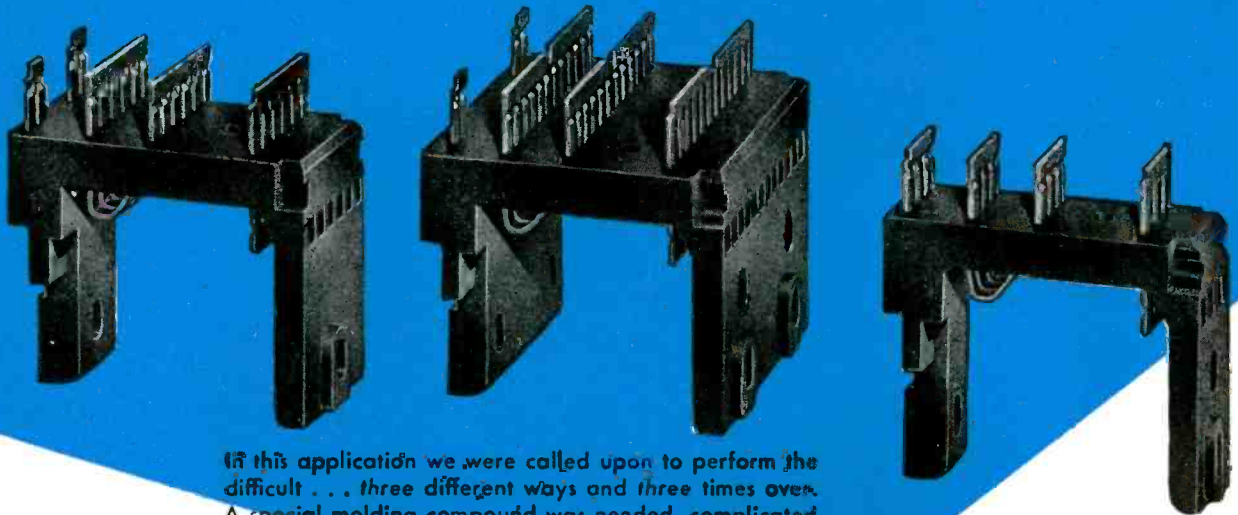

In this application we were called upon to perform the difficult . . . *three different ways and three times over.* A special molding compound was needed, complicated molds had to be built, and special jigs devised to speed the molding cycle. All this had to be done *three times over* for terminal blocks in different sizes.

All three parts were transfer molded in separate four-cavity semi-automatic molds. Because the complicated shape of the pieces could not be adapted to straight molding, two sets of removable cavities were constructed for each mold so that one could be used for molding while the other was being dismantled in specially designed disassembly jigs. Thus a continuous production cycle was maintained.

To meet the need for a free-flowing phenolic with good electrical properties, heat resistance and impact strength, our laboratory compounded a new material that in actual tests has surpassed all previously used commercial compounds.

So, whether your new problem in plastics be simple or three-fold, you can rely on Consolidated experience and know-how together with the complete facilities at our disposal to bring you a sound and ready answer. Inquiries invited.



Terminal blocks pictured here-with were molded of X-208F for the International Business Machines Corp.

Consolidated

MOLDED PRODUCTS Corporation
309 CHERRY STREET, SCRANTON 2, PA.

"Your Blueprint in Plastic"

PRODUCT DEVELOPMENT • MOLD DESIGN • MOLD CONSTRUCTION • PLUNGER MOLDING • TRANSFER MOLDING • INJECTION MOLDING • COMPRESSION MOLDING

Branches: NEW YORK, 1790 Broadway • CHICAGO, 549 W. Randolph St. • DETROIT, 550 Maccabees Bldg. • CLEVELAND, 4614 Prospect Av. • BRIDGEPORT, 211 State Street

The Power and Impedance Monitor

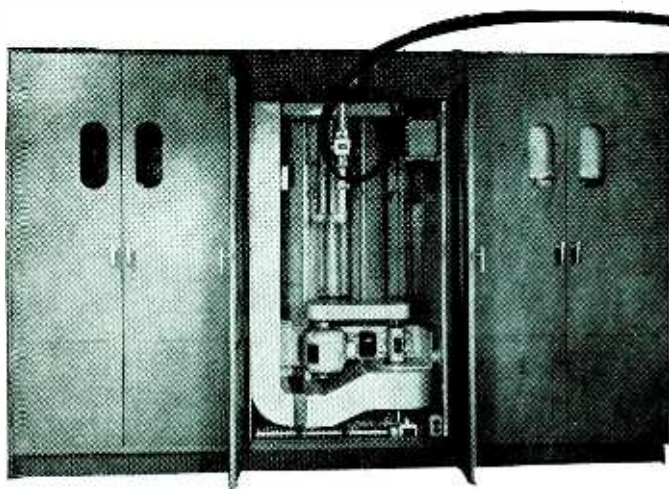

IT'S NEW . . .
 IT'S EXCLUSIVE!
 IT'S ONLY IN
Western Electric
FM TRANSMITTERS

It gives you for the first time...

- ✓ Accurate, direct measurement of the *actual RF power* fed into antenna system
- ✓ A simple method of measuring standing wave ratio under full power output

The new Power and Impedance Monitor designed by Bell Telephone Laboratories is another exclusive "plus" for users of Western Electric FM transmitters. It tells at a glance transmitter output power or reflected power in kilowatts ... gives a constant check on standing wave ratio while on the air ... automatically protects your equipment from excessive standing wave ratio. Here are the vital functions performed by this new device:

The MONITOR (B), located within the transmitter, registers on front panel meter the power in kilowatts actually going into the transmission line at any time, *no matter what the standing wave ratio on the line.*

The FRONT PANEL METER (A), connected to the Monitor, provides direct readings of output power and reflected power in kilowatts. Also gives a simple means for determining standing wave ratio at any time, *while the transmitter is in operation.*

The new Monitor is supplied as standard equipment with Western Electric FM transmitters of 3 kw and higher powers.

Write for literature describing in detail the operation of the new Power and Impedance Monitor. Address your request to Graybar Electric Co., 420 Lexington Ave., New York 17, N.Y., or see your local Graybar Broadcast Representative.



— QUALITY COUNTS —

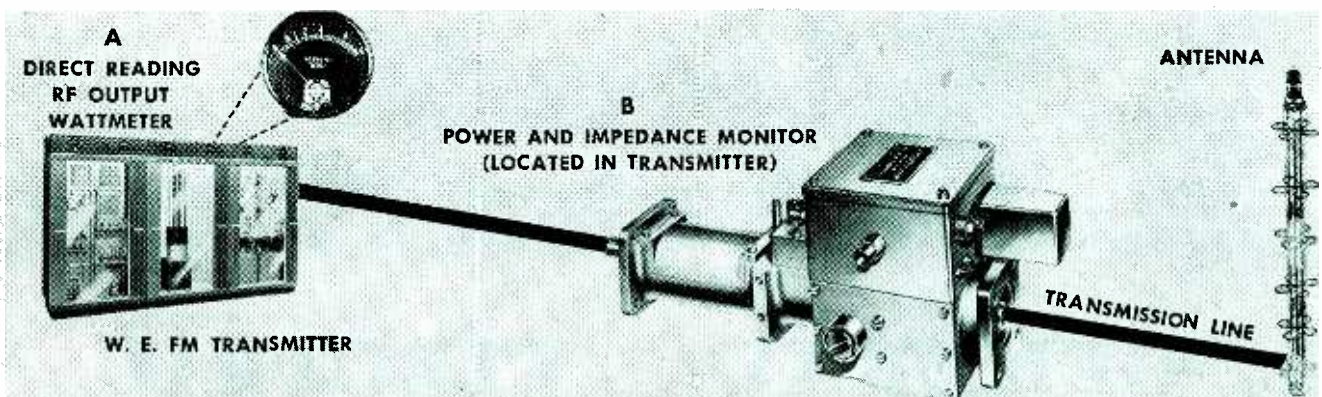

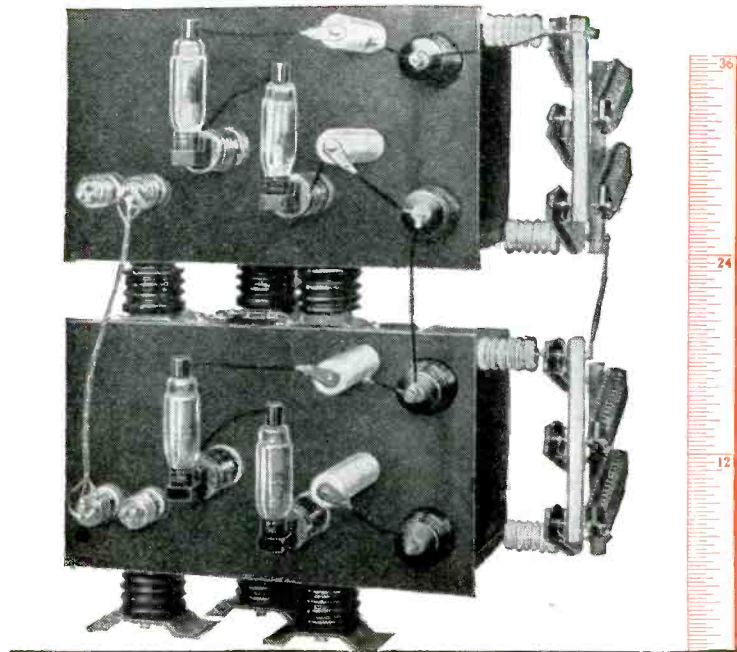

This unit, 40 inches high, delivers 70 kv., d-c. Consists of two basic Kenotron-tube rectifier units.

Now **SMALL RECTIFIERS** **FOR D-C VOLTAGES** *up to 165 KV*

New, within the last year, is this small cascade-type rectifier for generating smooth high d-c voltages. Suitable for laboratory and factory for testing and as power supply. Features: versatility, reliability, reasonably priced and long tube life with much lower cost of replacement tubes. Operates from 115-volt, single-phase, 60-cycle power supply.

Basic unit is a 35-kv, 30-ma (continuous) rectifier, with necessary transformers mounted in an oil-filled steel tank. Basic unit is 32" wide, 18" deep and 20" high. Up to five units can be stacked, giving d-c voltages up to 165

kv. Output voltage ripple, peak to peak, will not exceed 0.1% per milli-ampere.

Control Panel Optional. This unit can be supplied with a control panel which will provide smooth output voltage control over the complete range from zero to maximum. Accuracy of output voltage, with this panel, is ± 5 per cent of full scale; accuracy of current indication, ± 2 per cent. Overcurrent protection is included.

Suitable for integral mounting. Because of its small size, this rectifier can often be mounted within the enclosure housing

your own product. Such integral mounting is usually preferable from all standpoints—lowers cost, saves space, and improves appearance of the entire assembly.

Standard units, in regular production. These cascade rectifiers are built up of standard units that are in regular production. They can be shipped on shorter schedules than are normal for this general class of equipment.

For prices and specific information, address inquiries to our nearest office, or to *Apparatus Dept., Section B 401-49, General Electric Co., Schenectady 5, N.Y.*

GENERAL  **ELECTRIC**

401-49



Listen
...IT'S A
Jensen

MODEL VH-91
Hypex^{*} **SPEECHMASTER**

Delivering good quality, intelligible speech with maximum "punch" to override high noise levels, the Model VH-91 Speechmaster is recommended for paging and intercommunication applications. Hypex horn formula gives useful output over a 100° angle.

Especially efficient for voice, the VH-91 has a frequency range of 400-5,000 cycles. Power handling capacity: 15 watts maximum speech signal input. Designed for both inside and out-of-door use, VH-91 will withstand extreme weather conditions, including exposure to salt spray. Nominal voice coil impedance 8 ohms. Transformer number Z-3345, with $\frac{5}{8}$ " x $\frac{5}{8}$ " core available for 45-ohm use. Bell diameter, $8\frac{7}{8}$ inches; height, $9\text{-}1\frac{1}{16}$ inches; weight, $4\frac{1}{4}$ pounds.

Universal mounting bracket adjusts projector to any direction, locks securely in position by a single wing nut, has facilities for mounting transformer.

Jensen VH-91 Speechmaster Projector (ST-171).....\$32.50

*Trade mark registered

JENSEN MANUFACTURING COMPANY
6607 S. LARAMIE AVE., CHICAGO 38, U. S. A.
In Canada: Copper Wire Products, Ltd., 11 King St., W. Toronto 1



*Designers and Manufacturers
of Fine Acoustic Equipment*

* ANSONIA * Ankoseal

Flexible in Use...

Flexible in Application...

Proved in

many difficult installations,

Ansonia Ankoseal insulated wires

and cables retain their flexibility

though subject to a wide range of

temperatures, hard usage

and frequent bending

and twisting.

Wide flexibility in application is another value exceptionally true of Ansonia Ankoseal.

FOR

Control Cables

Cables requiring high dielectric strength, unusual resistance to heat, moisture, acids, alkalis and other destructive agents.

High Frequency Transmission

Portable Cables

Ankoseal provides an insulation adaptable to the requirements of each application.



Ansonia not only offers Ankoseal to meet a variety of insulating problems but our engineering staff has designed many cables for specific purposes.

You are invited to consult us regarding your wire or cable problems.

THE ANSONIA ELECTRICAL DIVISION

ANSONIA, CONNECTICUT of

NOMA ELECTRIC CORPORATION, NEW YORK, N. Y.

Announcing

SCOTCH *Sound Recording* TAPE

BRAND

OFFERING HOME AND PROFESSIONAL RECORDERS A NEW STANDARD OF TONE FIDELITY AND EASE OF HANDLING



Developed in the research laboratories of the 3M Company . . . the world's largest manufacturers of pressure-sensitive adhesive tapes . . . "SCOTCH" Sound Recording TAPE is now available in quantity for immediate delivery. No other magnetic recording medium can offer all these advantages:

1. Better frequency response at slow recording speeds—due to "SCOTCH" Sound Recording Tape's extremely thin, uniform magnetic coating.
2. Low noise level because of uniform dispersion of particles and mirror-like surface.
3. Higher Coercive Force—350 oersteds—insures higher frequency response and greater signal strength.
4. Flat surface and large area provide positive contact with the pick-up and give greater dynamic range.
5. Uniform width control in manufacture insures even, constant tracking.
6. Adequate space on $\frac{1}{4}$ inch width for multiple sound tracks.
7. The non-magnetic tape backing between the layers of magnetic coatings in the roll prevents "cross-talk."
8. Easy to handle. No snarls, backlashes, or kinks.
9. Freedom from breakage. Resin treated backing provides a tensile strength of 8 to 10 pounds.
10. Can be marked on back to indicate start and stop of different sound sequences in the same roll.
11. Easily edited by snipping out unwanted portions and then taping together with "SCOTCH" transparent Tape.
12. Perfect reproduction for several thousand playbacks. Erases clean with low power—no special erase head required.

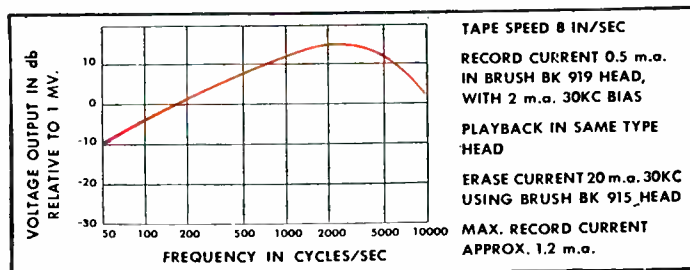

Licensee of Armour Research Foundation

Made in U. S. A. by **MINNESOTA MINING & MFG. CO.** Saint Paul 6, Minn.
 THE 3M COMPANY

For Antenna Current Measurements
at Television and FM frequencies!

WESTON

*High Frequency
Thermo Ammeters*

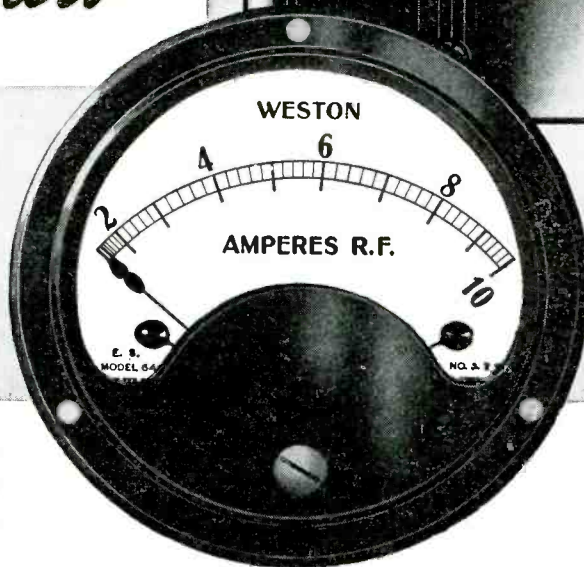
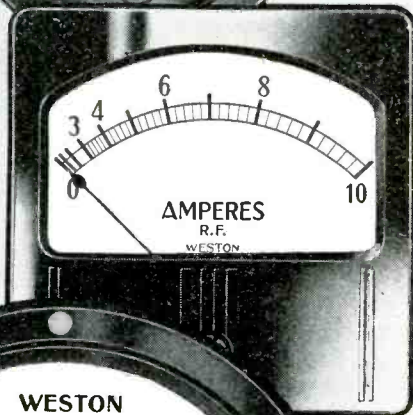
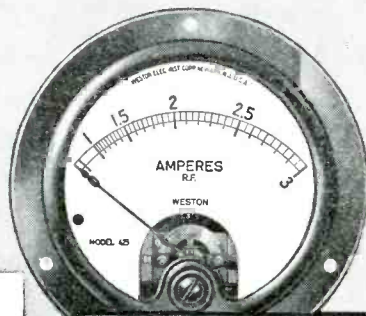

WESTON thermo ammeters are particularly designed for more accurate measurements of *very high frequency* antenna current in present FM and Television installations.

The thin-walled tubular heater*, an exclusive WESTON development, substantially reduces skin effect, thus providing vastly improved accuracy at the higher frequencies. Meeting FCC requirements, these instruments are available in sizes and ranges for all needs. Also vacuum-type thermocouple instruments for milliamperere ranges. Ask your local WESTON representative, or write Weston Electrical Instrument Corporation, 618 Frelinghuysen Avenue, Newark 5, New Jersey.

* Patent #2,100,260

WESTON
Instruments

ALBANY · ATLANTA · BOSTON · BUFFALO · CHARLOTTE · CHICAGO · CINCINNATI · CLEVELAND · DALLAS · DENVER · DETROIT · JACKSONVILLE · KNOXVILLE · LITTLE ROCK · LOS ANGELES · MERIDEN · MINNEAPOLIS · NEWARK
NEW ORLEANS · NEW YORK · PHILADELPHIA · PHOENIX · PITTSBURGH · ROCHESTER · SAN FRANCISCO · SEATTLE · ST. LOUIS · SYRACUSE · IN CANADA, NORTHERN ELECTRIC CO., LTD., POWERLITE DEVICES, LTD.

Nielsen Audimeter Uses **CLARE SEALED TYPE "K" RELAY** for Radio Audience Research

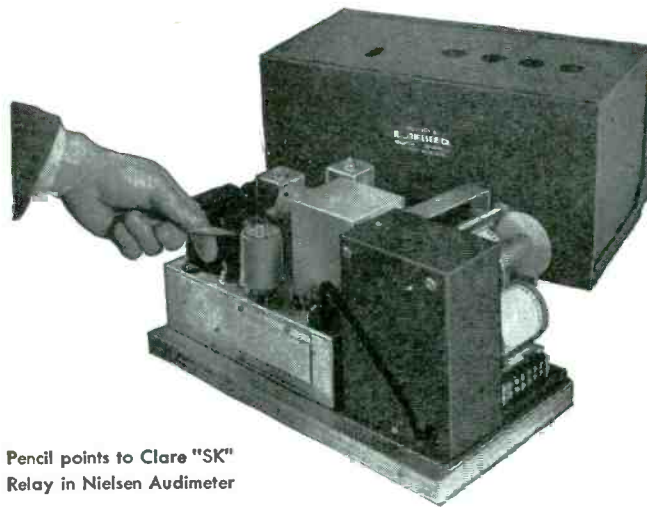
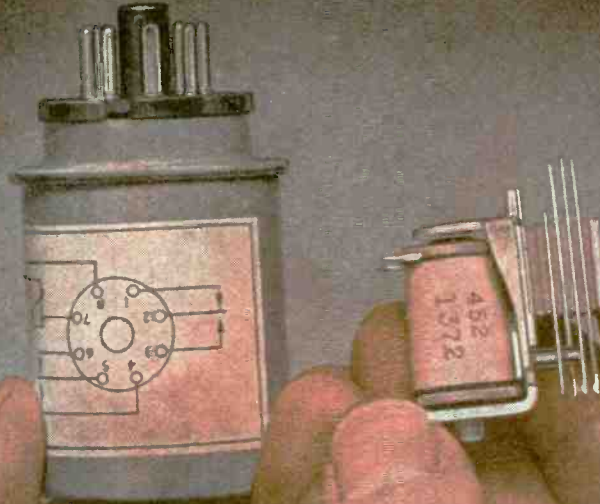

Pencil points to Clare "SK"
Relay in Nielsen Audimeter

One of the most interesting developments in radio listening research is the Audimeter, designed by A. C. Nielsen Company, Chicago marketing research organization, to provide information hitherto unobtainable.

Attached to home radio receivers, scientifically selected on a nation-wide basis, this device keeps an accurate 24 hour a day record of when each receiver is operated and the stations to which it is tuned.

Clare Sealed Type "K" Relays were chosen for use in the Audimeter because of their extreme reliability, capacity for precise, sensitive adjustment, and the fact that they are sealed so that dirt and handling cannot affect their operation.

In the Audimeter, the unusually sensitive Clare Sealed Type "K" Relay operates under the control of a vacuum tube to stop the recording stylus at the correct spot to identify station choice on the calibrated record tape.

Clare Sealed Type "K" Relays, sealed in nitrogen in a metal cover, are immune to conditions imposed by high altitudes, dust, moisture or combustible gases. They function at maximum precision under extreme conditions. Like all Clare "Custom-Built" Relays they are available in a wide range of contact ratings and contact forms, flat or hemispherical contacts of rare metals or special alloys and with coil windings to match the circuit and application.

Clare "custom-building" makes it possible... with the utmost economy... to secure a relay exactly suited to specific requirements. Clare sales engineers are located in principal cities to help you secure just the relay you need. Write to C. P. Clare & Co., 4719 West Sunnyside Avenue, Chicago 30, Illinois. In Canada: Canadian Line Materials Ltd., Toronto 13, Ontario, Canada.

CLARE RELAYS

"Custom-Built" Multiple Contact Relays for Electrical and Industrial Use

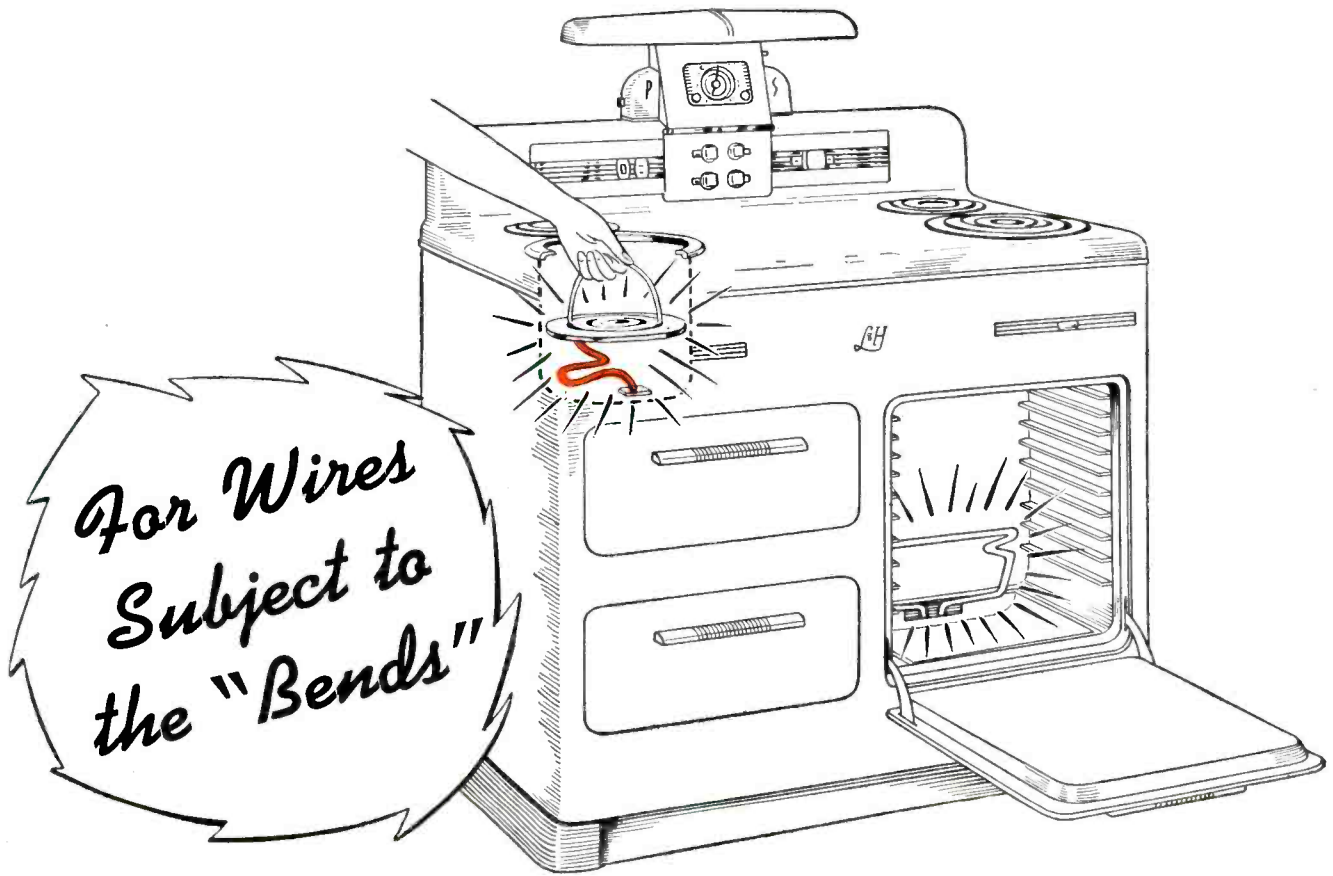

Ordinary insulation wouldn't do! When Lindemann and Hoverson designed the Shelby L & H Electric Range, they required an insulation to withstand severe bending. Each time the well-type deep fryer is removed and the heating element raised . . . each time the oven element is raised for cleaning, the lead wires are subject to excessive wear.

After using Bentley, Harris Extra Flexible Fiberglas Sleeving in this application for over a year, here is what they reported:

"BH Fiberglas Sleeving has proved to be

satisfactory in every way. It withstands the frequent bending without splitting or cracking. It does not react to the heat—either conducted through the wire or from the oven itself. The great flexibility and non-fraying qualities have aided considerably in speeding production."

Try BH Fiberglas Sleeving in your plant, in your own product. Learn why more and more manufacturers specify BH Fiberglas Sleeving for new products or to improve present models.

BENTLEY, HARRIS MFG. CO., CONSHOHOCKEN, PA.

BH *Fiberglas** SLEEVINGS

*BH Non-Fraying Fiberglas Sleevings are made by an exclusive Bentley, Harris process (U. S. Pat. No. 2393530). "Fiberglas" is Reg. TM of Owens-Corning Fiberglas Corp.

USE COUPON NOW

Bentley, Harris Mfg. Co., Dept. E-14, Conshohocken, Pa.

I am interested in BH Non-Fraying Fiberglas Sleeving for _____ (product) operating at temperatures of _____°F. at _____ volts. Send samples so I can see for myself how BH Non-Fraying Fiberglas Sleeving stays flexible as string, will not crack or split when bent.

NAME _____ COMPANY _____

ADDRESS _____

Send samples, pamphlet and prices on other BH Products as follows:

- Cotton-base Sleeving and Tubing
- Ben-Har Special Treated Fiberglas Tubing

For Versatility of Application

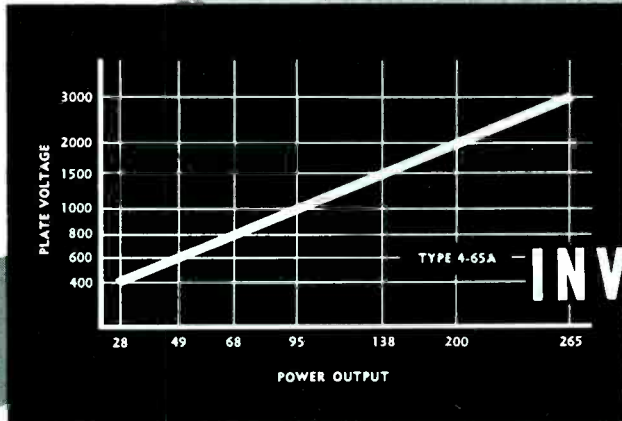

WITHIN THIS POWER RANGE

INVESTIGATE THE NEW

EIMAC 4-65A

MORE FOR YOUR VACUUM TUBE DOLLAR

Conservatively rated at 65 watts plate-dissipation, the 4-65A is physically small and radiation cooled.

Instant heating thoriated tungsten 6.0 volt filament makes the 4-65A ideally suited for mobile application.

Self-supported internal elements. No troublesome insulators.

Direct electron beaming without the use of deflecting hardware.

Low interelectrode capacitances. (Average) Grid-Plate .08 μf , Input 8.0 μf , Output 2.1 μf .

Unique design shields input output circuits, simplifies neutralization.

Non-emitting processed grid provides stability familiar to all Eimac tetrodes.



ACTUAL SIZE

Versatile operation . . . the 4-65A has excellent power characteristics over a plate voltage range from 400 to 3000 volts, as indicated in the above chart.

Base pins fit available commercial sockets.

Low inductance and short direct leads enable operation above 200 mc.

Processed metal plate assures long tube life and can really "take it" during momentary overloads.

Hard glass envelope provides resistance to thermal shock and permits high temperature operation.

Proven design, the 4-65A is a physically smaller version of the 4-125A.

In the 4-65A you get truly "more for your vacuum tube dollar"

PRICE \$14.50

EITEL-McCULLOUGH, Inc.
179 San Mateo Ave.,
San Bruno, California

Write today for additional data.

Follow the Leaders to
Eimac
TUBES
The Power for R-F
EXPORT AGENTS: FRAZAR & HANSEN, 301 CLAY ST., SAN FRANCISCO 11, CALIFORNIA, U.S.A.

MOTORS FOR SOUND RECORDING

MUST HAVE
**LOW NOISE LEVEL
MINIMUM VIBRATION
CONSTANT SPEED**

For Prompt Service

CONTACT THESE



REPRESENTATIVES

JOE DAVIDSON & ASSOCIATES

P. O. Box 108
South Gate, Calif.
Tel: Kimball 7244

ALLEN I. WILLIAMS, JR.

230 Cooper Building
Denver 2, Col.
Tel: Ma. 0343

FRANK W. YARLINE & CO.

20 No. Wacker Drive
Chicago 6, Ill.
Tel: State 0347

HARRIS-HANSON CO.

427 No. Euclid Ave.
St. Louis 8, Mo.
Tel: Forest 5841

ENGINEERING SALES CO.

124 No. Montgomery St.
Trenton 8, N. J.
Tel: Trenton 9885

HOLLIDAY-HATHAWAY
SALES CO.

238 Main Street
Cambridge 42, Mass.
Tel: Eliot 1751

GEORGE T. WRIGHT

19859 Beach Cliff Blvd.
Cleveland 16, Ohio
Tel: Boulevard 9554

WILLIAM J. COTTRELL CO.

309 S. W. Third Avenue
Portland 4, Oregon
Tel: Broadway 3120

AIRPARK CORPORATION

412—5th Street, N.W.
Suite 501
Washington, D. C.
Tel: National 4642

STANDARD PARTS &
EQUIPMENT CORP.

904 North Main
Forth Worth, Texas
Phone 2-4459

EASTERN AIR DEVICES
SYNCHRONOUS SOUND RECORDER MOTORS

*Give Smooth, Flawless Performance
ON ANY TYPE OF DISC, WIRE, TAPE
or FILM RECORDER*

1. NO NOISE
2. NO VIBRATION
3. HUNT and "WOW" ELIMINATED

These Motors Now in Production

TYPE	H.P.	SPEED
LH73NCJ	1/50	1800 R.P.M.
LH73QCJ	1/100	1800 R.P.M.

WRITE FOR SAMPLES

Similar Motors are Available For:
CAMERAS • PROJECTORS • FACSIMILE

EASTERN AIR DEVICES, INC.

585 DEAN STREET • BROOKLYN 17, N. Y.



HORIZONS UNLIMITED

- Today there's no mystery about the Klystron tube. It's being used in a lot of things you see and read about every day . . . radar, television, communications and even medicine.
- Radar with Klystrons guides merchant ships and sky giants through fog, smoke, clouds. You'll find it in television relays . . . in medical diathermy . . . in dielectric heating . . . in telephone, telegraph, aircraft radio and broadcast radio relays.
- We're anxious to put the Klystron to work even harder.

We know there must be many undeveloped applications that will make your products better or help you make new products. The Klystron is adaptable in both local oscillator and high power applications.

- Sperry engineers will gladly cooperate with manufacturers in adapting Klystron to new fields.



Sperry Gyroscope Company, Inc.

EXECUTIVE OFFICES: GREAT NECK, NEW YORK • DIVISION OF THE SPERRY CORPORATION
NEW YORK • CLEVELAND • NEW ORLEANS • LOS ANGELES • SAN FRANCISCO • SEATTLE



KFIZ Fond du Lac, Wis.

"For the past four months we have had the G-E consolette in constant operation and are thoroughly sold on it, because it is adaptable to almost any operation. Its versatility and accessibility make it 'tops' in studio control."

LYNN N. FAIRBANKS, *Gen'l Mgr.*



WSYR-FM Syracuse, N. Y.

"For on-the-air reliability we've found that the G-E 3 kw. FM transmitter fully meets our performance specifications. It was easy to install—easy to maintain. We have no worries about this transmitter ever failing us."

A. G. BELLE ISLE, *Chf. Eng.*



WFJS Freeport, Ill.

"We have been using the G-E consolette for six months, and are more than happy with its design and flexibility."

THOMAS C. MOERS, *Sta. Mgr.*

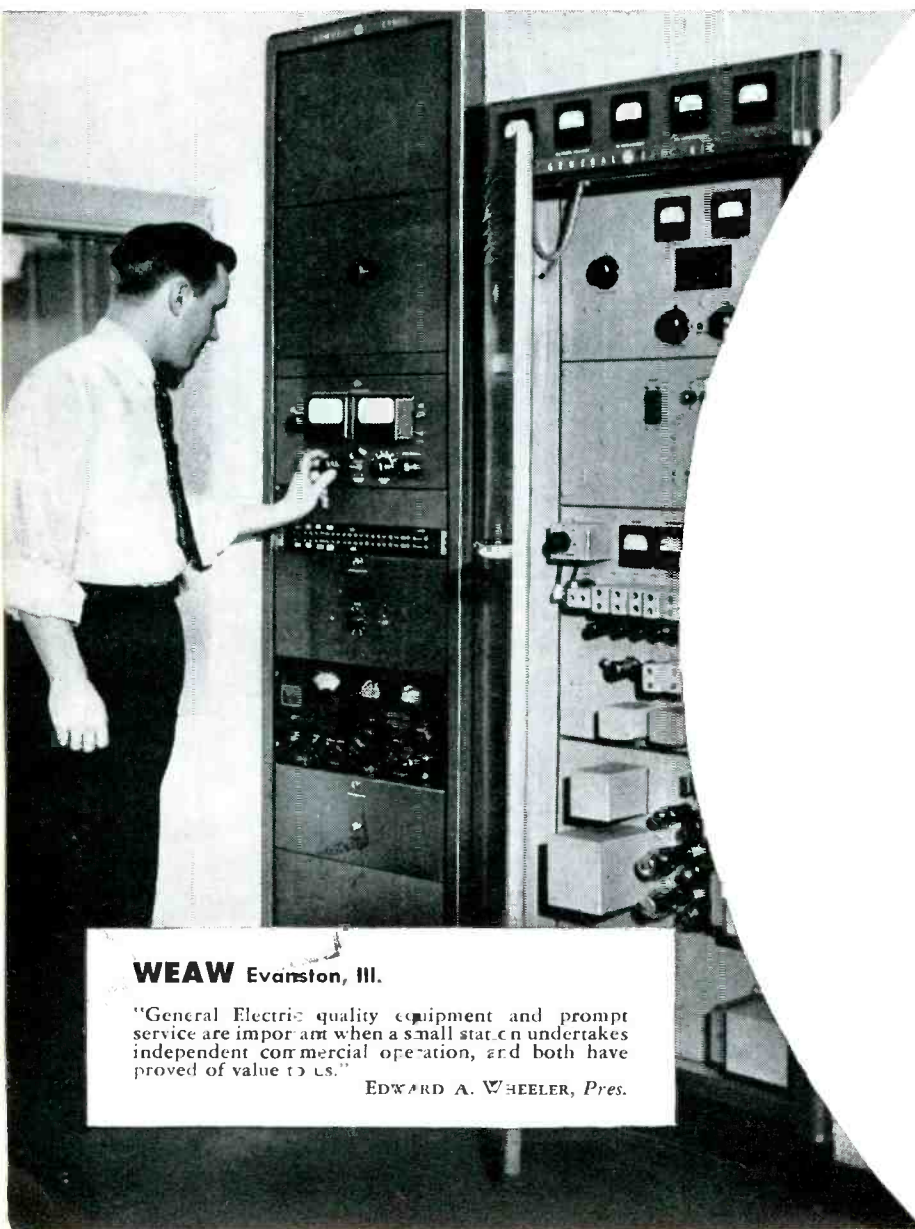

WEAW Evanston, Ill.

"General Electric quality equipment and prompt service are important when a small station undertakes independent commercial operation, and both have proved of value to us."

EDWARD A. WHEELER, *Pres.*

IN FM

Station after station tells the story

AS we go to press, 155 General Electric FM transmitters are on the air or being installed in broadcasting stations. Each week more and more G-E FM equipment is being shipped to buyers everywhere.

Pioneer in FM, General Electric is the leader in extending this finer system of broadcasting to all America.



WMLN Mt. Clemens, Mich.

"The outstanding flexibility of the General Electric consolette provides us with fingertip control of all broadcasting features plus monitoring, auditioning, and extra program amplifier in one compact unit."

W. A. SCHATTLER, *Chf. Eng.*



KOCS Ontario, Cal.

"KOCS is designed and built for maximum efficiency and performance in every detail. We are delighted in that respect with our G-E FM transmitter. It's a top performer."

JERENE APPLEBY HARNISH, *Pres.*

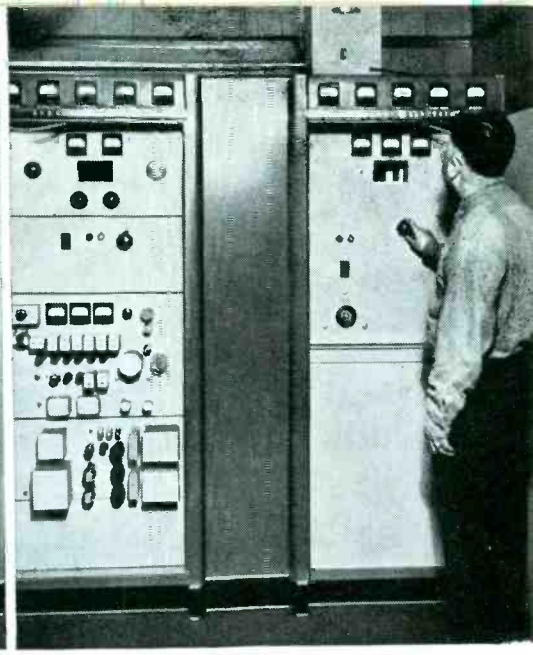

WEBC Duluth, Minn.

"The G-E FM transmitter was very easy to place in operation. The radio frequency stages tune up properly, and there are no trick adjustments to make in order to keep the transmitter functioning properly."

W. H. LOUNSBERRY, *Chf. Eng.*

IT'S G.E.

General Electric FM equipment is available for every need.

Station owners and engineers go all out for G-E equipment. Read what they say. Then call your nearest G-E radio sales engineer, or write *Electronics Department, General Electric Company, Syracuse 1, N. Y.*

WTRI Troy, N. Y.

"General Electric's 250 watt FM transmitter obviously was built with an eye on economy to the user. Its components are all assembled in logical order for instant installation and easy maintenance. Per hour of operation, we find the cost is far below our expectations."

ALBERT H. CHISMAR, *Chf. Eng.*

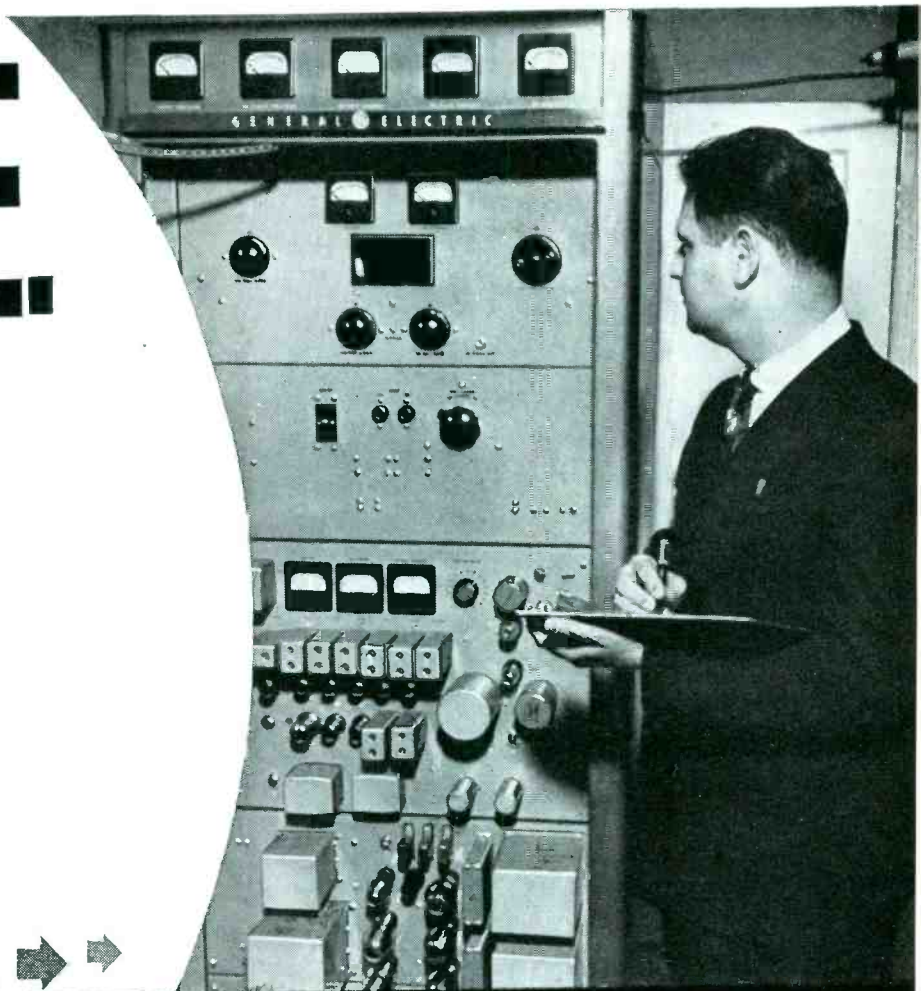

GENERAL ELECTRIC

LEADER IN RADIO, TELEVISION AND ELECTRONICS

160-F7-6014

Accent on

MOTION

Driving the heavier type record changers, radio phonograph turntables and tuning devices—powering fans, motion displays, actuating switches, levers and timing devices—operating business and vending machines, toys—these are just a few of the tasks performed by Alliance's Model K Powr-Pakt motor.

This basic 2-pole induction type motor can be mass produced to meet variations in design. It will adapt to any standard AC voltage and frequency, and will develop up to 1/100th h. p. For intermittent duty or where forced ventilation is provided even greater output can be obtained. Model K is used in all 25-cycle and in some 50 and 60-cycle Alliance phonomotors.

The trend is to make things move!

Designs will call for more action—movement! Flexible product performance needs power sources which are compact, light weight! Alliance Powr-Pakt Motors rated from less than 1-400th on up to 1-20th h.p. will fit those "point-of-action" places! Alliance Motors are mass produced at low cost—engineered for small load jobs!

For vital component power links to actuate controls... to make things move... plan to use them!

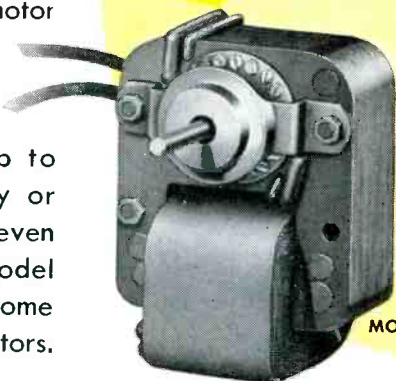

MODEL K



WHEN YOU DESIGN—KEEP

alliance

MOTORS IN MIND

ALLIANCE MANUFACTURING COMPANY • ALLIANCE, OHIO
EXPORT DEPARTMENT: 401 BROADWAY, NEW YORK 13, NEW YORK, U. S. A.

Resistance Control Problems

"Taper Off"

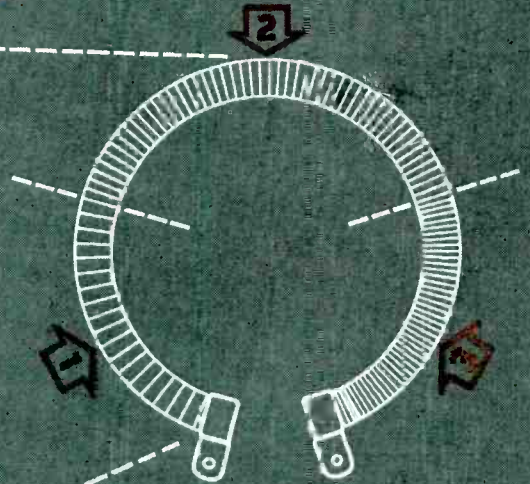
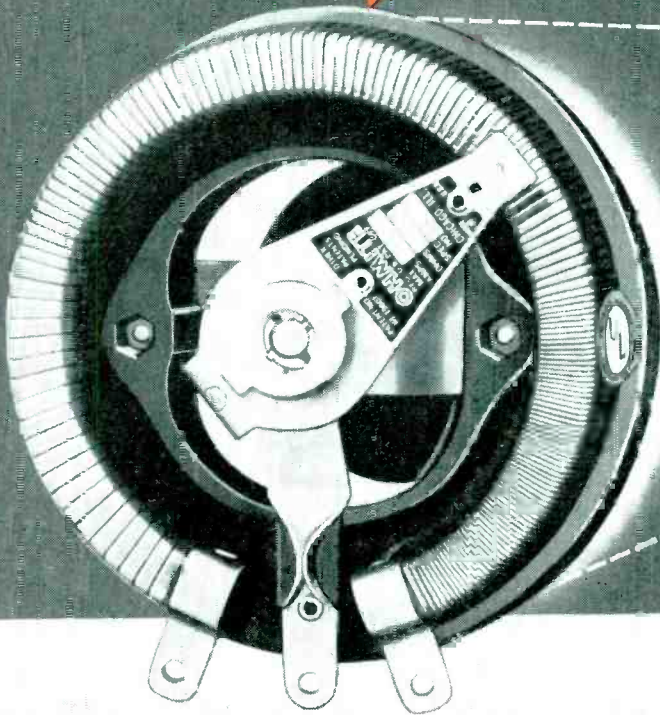

Note how three sectional windings of Driver-Harris nickel-chrome alloys: (1) No. 95, (2) Advance, and (3) N'chrome, are employed to obtain fine resistance shading.

When Rheostats are Sectionally Wound with **DRIVER-HARRIS Alloys**

To provide more uniform current control—and a rheostat of proportionately smaller size—the Ohmite Manufacturing Co. advocates tapered windings, involving the use of two or more sections of diminishing wire sizes. This construction is practical because only the first turn of any rheostat winding carries the maximum current. All succeeding turns carry constantly decreasing amounts.

In the 3-section, 500 watt Ohmite Model R Rheostat illustrated, three Driver-Harris nickel-chrome alloy wires—*Nichrome**—

*Advance**—and *No. 95* are employed to obtain the fine shading of resistance desired. For other resistance combinations, there are more than 80 Driver-Harris *electrical resistance alloys* specifically designed to fill the numerous requirements of the Electrical and Electronic Industries.

Backed by 46 years of specialized resistance-research experience, the Driver-Harris engineering staff is ready at all times to help you solve your electrical resistance problems. Why not get in touch with them for expert advice—or write for 71-page Resistance Handbook, R46.



Driver-Harris
COMPANY
HARRISON, N. J.

BRANCHES: Chicago • Detroit • Cleveland • Los Angeles • San Francisco • Seattle
The B. GREENING WIRE COMPANY, LTD., Hamilton, Ontario, Canada

*Trade Mark Reg. U. S. Pat. Off.

SPRAGUE KOOLOHM

(T. M. Reg. U. S. Pat. Off.)

**WIRE-WOUND
RESISTORS
5 TO 120 WATTS**

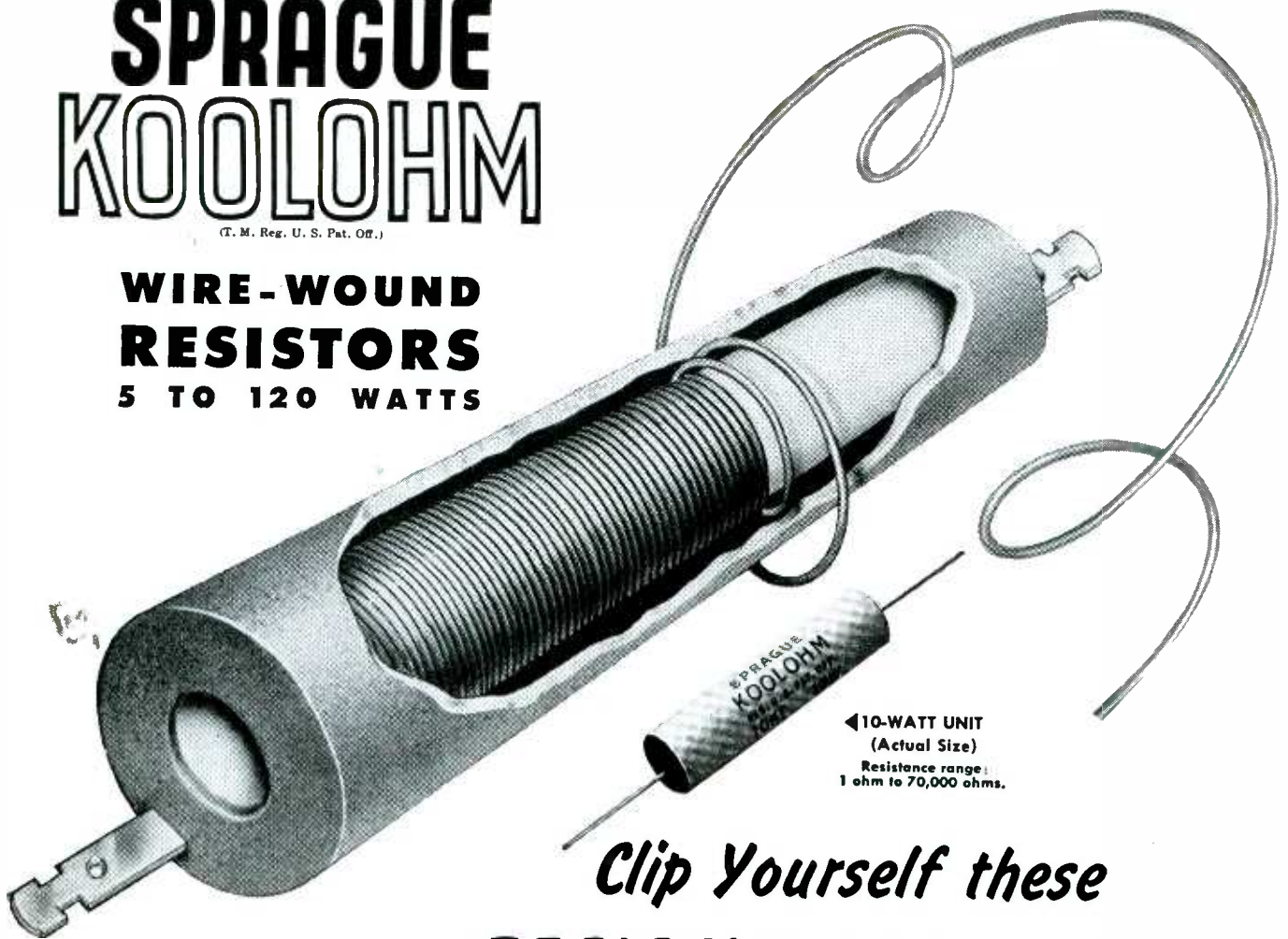

◀ 10-WATT UNIT
(Actual Size)
Resistance range:
1 ohm to 70,000 ohms.

Clip Yourself these RESISTOR DIVIDENDS!

SAFE FOR USE AT FULL WATTAGE RATINGS—FOR ALL RESISTANCE VALUES—Koolohm ceramic wire insulation is ideal for rapid heat dissipation.

QUICKER, MORE ECONOMICAL MOUNTING—Koolohms are doubly protected—first by the heat-proof, moisture-resistant ceramic wire insulation; second, by an outer ceramic shell. Mount them in any position—anywhere—in enclosed places—even directly on grounded parts.

NO SHORTED TURNS—NO CHANGED RESISTANCE VALUES—5% accuracy or better is guaranteed. Koolohm windings touch, but do not short. The flexible ceramic wire insulation has a dielectric strength of 350 volts per mil at 400° C.

SMALLER PHYSICAL SIZES—Space winding is unnecessary. Where required, windings can be made in layers or interleaved for maximum rating in minimum space.

ALL-WEATHER PROTECTION—One Sprague Koolohm type—the standard type at standard prices—gives adequate protection under any climatic condition, anywhere in the world.

HIGH-VOLTAGE INSULATION—Koolohms withstand 10,000 volts breakdown to ground.

Write for Catalog 100E. Samples gladly submitted to your specifications. You be the judge!

OTHER SPRAGUE RESISTOR TYPES

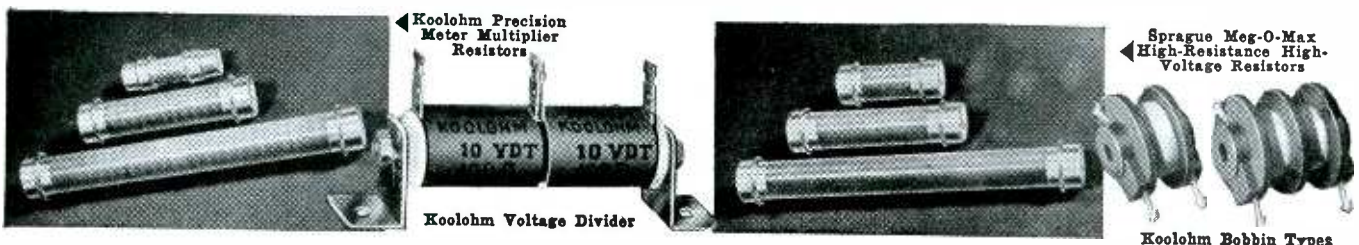

SPRAGUE ELECTRIC COMPANY

RESISTOR DIVISION, NORTH ADAMS, MASS.



GUARDIAN stepping relays

FOR SELECTION AND CONTROL OF MULTIPLE CIRCUITS

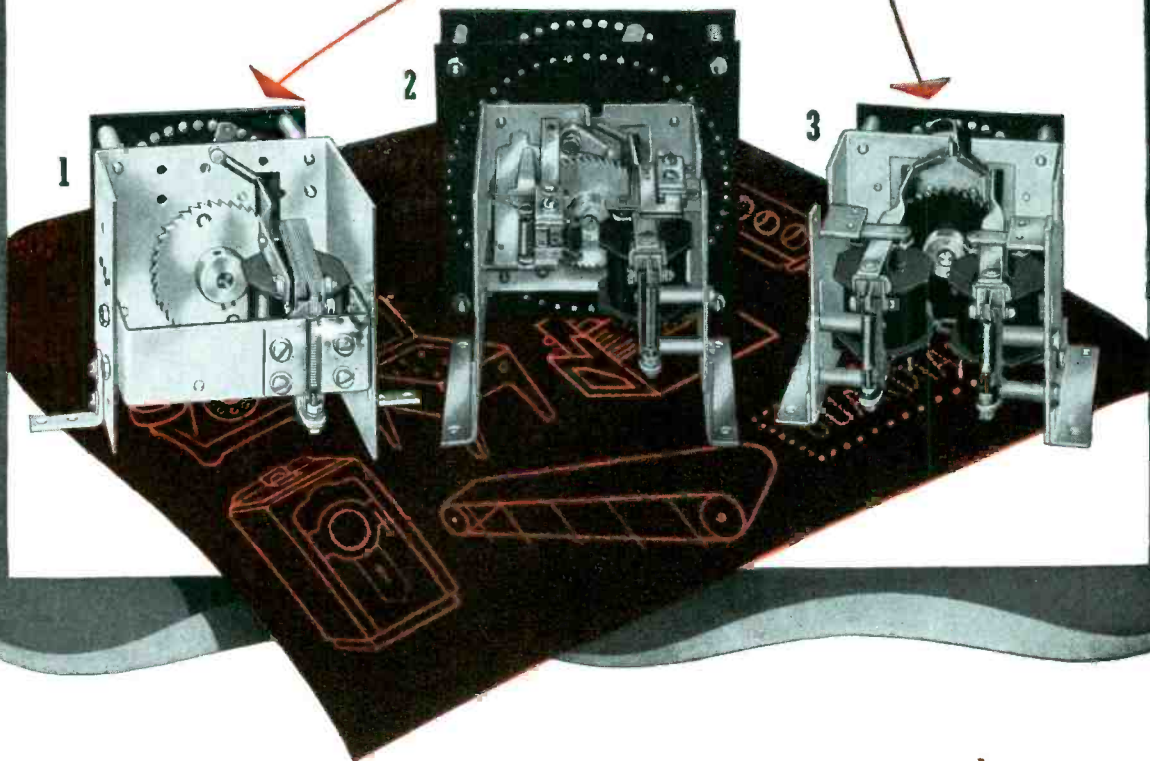

This trio of standard Guardian Stepping Relays: (1) continuous rotation, (2) electrical reset, (3) add and subtract—will start you off with a minimum of design and keep your products operating indefinitely. The Guardian Steppers shown are adaptable to numerous applications: automatic circuit selection; automatic sequence selection of circuits; automatic sequence cross-connection of circuits. They are used in automatic business machines, production totalizers, conveyor controls, animated displays, telephony, remote tuning, with a host of additional uses you will soon discover. On each, the contact finger rotates counter-clockwise. All three Steppers follow 10 pulses per second within the rated voltage range of the relay. Special construction prohibits skipping or improper indexing of the ratchet. Available in separate units or in combination with relays, contact switches, solenoids; completely assembled and wired to terminals; mounted on special bases or in enclosures. "Special" modifications are obtainable in production quantities. Write for Bulletin SR.

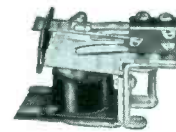

Series 100 Snap-Action Relay



Guardian Featherub Switch



Series 500 Midget Relay



Series T-A Solenoid

GUARDIAN ELECTRIC

1625-K W. WALNUT STREET

CHICAGO 12, ILLINOIS

A COMPLETE LINE OF RELAYS SERVING AMERICAN INDUSTRY

BUSINESS BRIEFS

By W. W. MacDONALD

RECTANGULAR-CASE SUPEREX* CAPACITORS COMBINE SMALL SIZE AND LONG LIFE

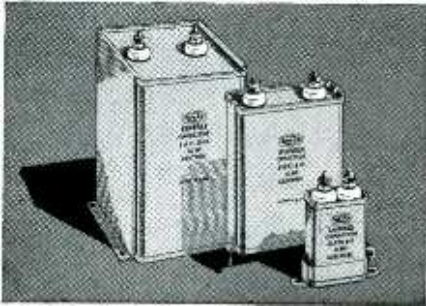

The Type XLXP series of Superex-treated paper-dielectric capacitors is conservatively designed to meet the exacting requirements of industrial electronic equipment and commercial radio apparatus. The synthetic, non-flammable Superex impregnant and fill assures long life, small size, high insulation resistance, low power factor, and stability of electrical characteristics at elevated temperatures.

Capacitors are furnished in gray-lacquered hermetically-sealed fabricated tereplate containers with high-voltage porcelain terminal bushings.

Type XLXPL units are supplied with hook-on flar-flange mounting brackets; Type XLXPJ units are supplied with hook-on spade-bolt brackets; and Type XLXPU capacitors have wrap-around universal mounting brackets.

Maximum capacitances for standard voltage ratings are as follows:

WVDC	Max. Mf.
12,500	0.5
10,000	1.0
7,500	2.0
6,000	2.0
5,000	4.0
4,000	6.0
3,000	8.0
2,500	12.0
2,000	15.0
1,500	15.0
1,000	15.0
600	25.0

For further information, see your Solar representative or write to Solar Manufacturing Corporation, 1445 Hudson Blvd., North Bergen, N. J. Plants at Chicago, Ill., Bayonne and North Bergen, N. J.

*Trade Mark

Ⓢ 3326



Electronic Devices are being used in only five per cent of the applications where they could be useful, according to Edward U. Condon, Director of the National Bureau of Standards.

Several Letters ask if privately-owned shore-to-ship stations are being experimentally licensed for operation in the 152-162 mc maritime mobile band. As near as we can find out the situation appears to be as follows:

Nine frequencies have been allocated for experimental use in that range but no construction permits have yet been granted for private service. A hearing is to be held by the FCC at some future date on applications filed by Foss Launch and Tug of Seattle, Meseck Towing Lines and Moran Towing and Transportation of New York. Decision on this case will probably determine future policy, so the thing for other interested companies to do is to file experimental license applications in Washington on the odd chance that all such applications on hand when the hearing is held may be considered at one time.

Meanwhile, common-carrier experimental maritime mobile station construction permits have been assigned to AT&T in New York, Western Union in the same city, and to Wayne Miller in Mobile, Alabama.

Geological Radio Licenses total 500, as against 131 in 1935. Practically all of them involve a plurality of mobile and portable units, and are held by oil companies or their subsidiaries.

Noise is a major problem in Canada because of the distances radio signals must travel to reach remote areas. The subject came in for a good deal of attention at a recent technical meeting north of our border, with manufacturers of electrical appliances and power

companies as well as receiver makers exhibiting great interest.

It is our guess that suppression of noise will soon be a major problem in the United States, what with television and many new mobile services rapidly gaining headway in the field. Cooperative effort will be needed. Count us in.

Packaged Wiring is still very much in the news. We hear that a manufacturer of industrial controls already preforming busbar and dropping it into channels moulded in chassis may soon go a step farther and use sprayed wiring. Experiments conducted in this firm's development lab indicate that it may not be necessary to use a screen process. Sprayed metal sticks to roughened portions of plastic chassis, and is readily wiped off smooth areas.

RCA Earnings in the last 10 years are as follows:

YEAR	GROSS INCOME	PROFIT AFTER TAXES
1937*	\$112,639,498	8.0%
1938*	99,968,110	7.4
1939*	110,494,398	7.3
1940*	128,491,611	7.1
1941	158,695,722	6.4
1942	197,024,056	4.6
1943	294,535,362	3.5
1944	326,421,913	3.1
1945	279,503,615	4.0
1946	236,980,770	4.6
AVERAGE . . .	\$194,475,505	4.9

* Including foreign subsidiaries. Other years include domestic subsidiaries only.

Factory Tele Service and installation stations may be necessary in order to get the new video business rolling fast and still make equipment stick but many people, including service-wise John Rider, believe that much of this work will ultimately have to be handled by independents.

Remembering our own early radio servicing experiences dating back to 1924, and following conversations with many friends still in the game, we are inclined to agree. And offer television receiver manufacturers this advice for what it is worth: Start out the way you think best. But encourage

FOR { ACCURACY AT HIGH SPEEDS DEPENDABILITY—DURABILITY

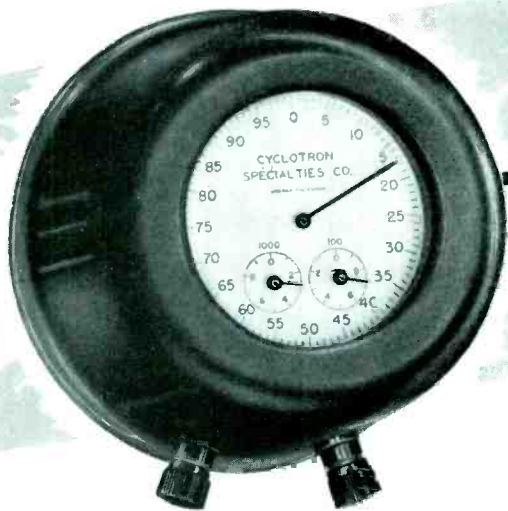

Cyclotron Specialties Impulse Register was originally designed to meet the exacting requirements of radioactivity research workers. Through outstanding performance, this counter has become a standby in many fields of scientific work throughout the entire world.

The Cyclotron Specialties Register is unique in its ability to operate at exceptionally high speeds with complete accuracy and without adjustment or maintenance. It is unexcelled for high speed impulse recording and mechanical operations requiring counting in precise quantities.

The operation of the Cyclotron Specialties Impulse Register is entirely automatic. Originally designed for our Geiger-Muller Counter Sets, it has found numerous other applications... both industrial and research... including:

- PRECISE CONTROL OF QUANTITIES (Packaging, Sorting, etc.)
- CUTTING OF MATERIALS, FABRICS, etc., to EXACT LENGTHS
- CONTROLLING VARIOUS MECHANICAL OPERATIONS
- CONTROLLING FUNCTIONS such as TIME, DIMENSIONS, VELOCITY, etc.

Inquiries for special types and modifications including higher speeds, electrical reset, flush panel mounting and higher totalization will now receive prompt attention.

ELECTRONICS — September, 1947

*an Impulse Register
that has gained
WORLD-WIDE* RECOGNITION*

*These are only a few of the many users of
Cyclotron Specialties Impulse Registers:*

GENERAL ELECTRIC COMPANY
FORD MOTOR COMPANY
E. I. DU PONT DE NEMOURS & CO.
SOCONY VACUUM OIL
WESTINGHOUSE ELECTRIC CORPORATION
BELL TELEPHONE LABORATORIES
U. S. ATOMIC ENERGY COMMISSION
GENERAL FOODS CORPORATION
NORTH AMERICAN PHILIPS CO.
RADIO CORP. OF AMERICA
EASTMAN KODAK COMPANY
DOW CHEMICAL COMPANY
U. S. RUBBER COMPANY
MONSANTO CHEMICAL COMPANY
AMERICAN CYNAMIDE & CHEMICAL CORPORATION
Over 600 American and Foreign Universities

★ SPECIFICATIONS of Cyclotron Specialties Impulse Register No. 401-A

ACCURATELY REGISTERS UP TO
60 IMPULSES PER SECOND

Main, easily-read sweep dial reads 0 to 100 directly.
Sweep dial plus auxiliaries read 0 to 9,999 impulses
without extra equipment.

4000 ohm D. C. resistance.
Operates on as low as 100 milliwatt.

Small, compact, light weight. Attractive plastic case
with non-removable-top binding posts.

Durable, rugged construction to withstand unavoidable accidents.
Dimensions: 3" x 4" Weight: 2 lbs.

Immediate Delivery in Reasonable Quantities

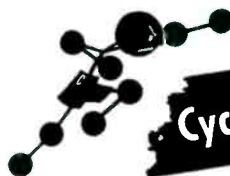

Cyclotron Specialties Company

Moraga 9, California



for



precision resistors



Designed to meet
Joint Army-Navy
Specification R-93



- PRECISION SWITCHES**
350 designs for instruments and high-grade electrical apparatus
- HIGH-VOLTAGE TEST EQUIPMENT**
1.5 to 200 KV
- BRIDGES**
Wheatstone, Kelvin-Wheatstone, Percent Limit and Fault Location Types
- DECADE BOXES**
1 to 7 dial types,
0.1 to 11, 111, 110 ohms
- VOLTAGE DIVIDERS
(DECADE POTENTIOMETERS)**
Voltage ratios 0.0001 to 1.0
- LOW RESISTANCE TEST SETS**
From 200 micro-ohms to 100 ohms
- ATTENUATORS & CONTROLS FOR
COMMUNICATION EQUIPMENT**

14 standard Shallcross Akra-Ohm Precision Resistors and 50 available adaptations combining special terminals, mountings and power ratings match almost any specification.

Normal accuracy is $\pm 1\%$. Tolerances as close as 0.05% where required. Temperature coefficient to meet any requirement. All types can be wound with either manganin, copper-nickel, or nickel-chrome or other wire alloys as desired. All designs are highly moisture repellent and unaffected by humidity. Normal resistance ranges from fraction of an ohm to 20 megohms.

Write for free copy of Shallcross
Precision Resistor Guide

SHALLCROSS MANUFACTURING CO.
Dept. E-97, Collingdale, Pa.

independents to acquire the necessary knowledge in every possible way. Above all, don't cut them off.

Microwave Relay Equipment for television studio-to-station and/or network operation interests at least 25 per cent of the people now on the air, holders of construction permits, applicants, and consulting engineers active in the field. That's the return Philco's Les Woods received when he sent out a letter inviting such people to write in for technical data.

Home Receivers have long been the dog and other communications apparatus the tail in the electronics field. Now it looks like the tail might wag the dog in our time, what with buyer's strikes in the household-goods market as contrasted with continuing healthy demand for transmitters and receivers among old and many new commercial users.

Voltage Regulators are attaining considerable popularity among manufacturers of all kinds of electrical as well as electronic equipment manufacturers for the performance of production tests. So far, we have heard of their use in test setups for vacuum-cleaner motors, switches, circuit-breakers and clocks. Details in our feature pages soon.

It Has Often Been Said that the electronics field sells a lot of things to itself. Nowhere is this fact more noticeable than among manufacturers of transmitters and r-f heating apparatus who happen also to make tubes. Frequently they will be found using tubes made by somebody else. And the answer is that so many types are required that no one manufacturer would find it economically sound to make them all.

Speaking Of Heating, industrial plants in which the use of electronic methods represents a potential saving of, say, 10 percent over older methods should be willing to plough back 2 percent for the services of a maintenance man who really understands the gear. Other-

wise, the saving permitted by the use of electronics may never be achieved.

When plants using steam engines as a source of power added electricity they employed an electrical as well as a steam engineer. They should be equally aware of the fact that a maintenance man who can handle 60-cycle stuff in his sleep may not necessarily feel at home with tubes.

Radio Stations in the United States total 125,000. This figure includes 1,200 broadcast stations (not counting the 1,000 or more under construction) and 70,000 amateur stations.

There are 325,000 licensed commercial radio operators, and 75,000 licensed amateur operators.

FCC Says the nation's seven major networks and 924 a-m broadcast stations had 34,831 employees in February 1947, as compared with the 29,405 employed by nine networks and 876 stations in October 1945.

Employees other than executive, supervisory and non-staff were receiving an average of \$61 weekly, for about 39 hours.

Deliveries of domestic broadcast transmitters and studio equipment by RMA member-companies totaled \$3,257,394 in the first quarter of 1947, as against \$2,863,440 in the last quarter of 1946. (Television equipment sales were lumped into the 1946 figure, are not included in the 1947 report.) A-M equipment sales jumped from \$788,567 to \$1,135,868, while f-m equipment sales went from \$389,844 to \$943,812.

Radios In Use in homes, estimated by the FCC's economics division: A-M 66,000,000. F-M 500,000. Television 7,000.

Around This Office nearly everything is translated into electronic terms. The writer, for instance, uses a Norma automatic pencil that has leads of four different colors. The one you want slides into writing position when the proper button is pressed. It is known locally as *the pencil with the three shortwave bands*.

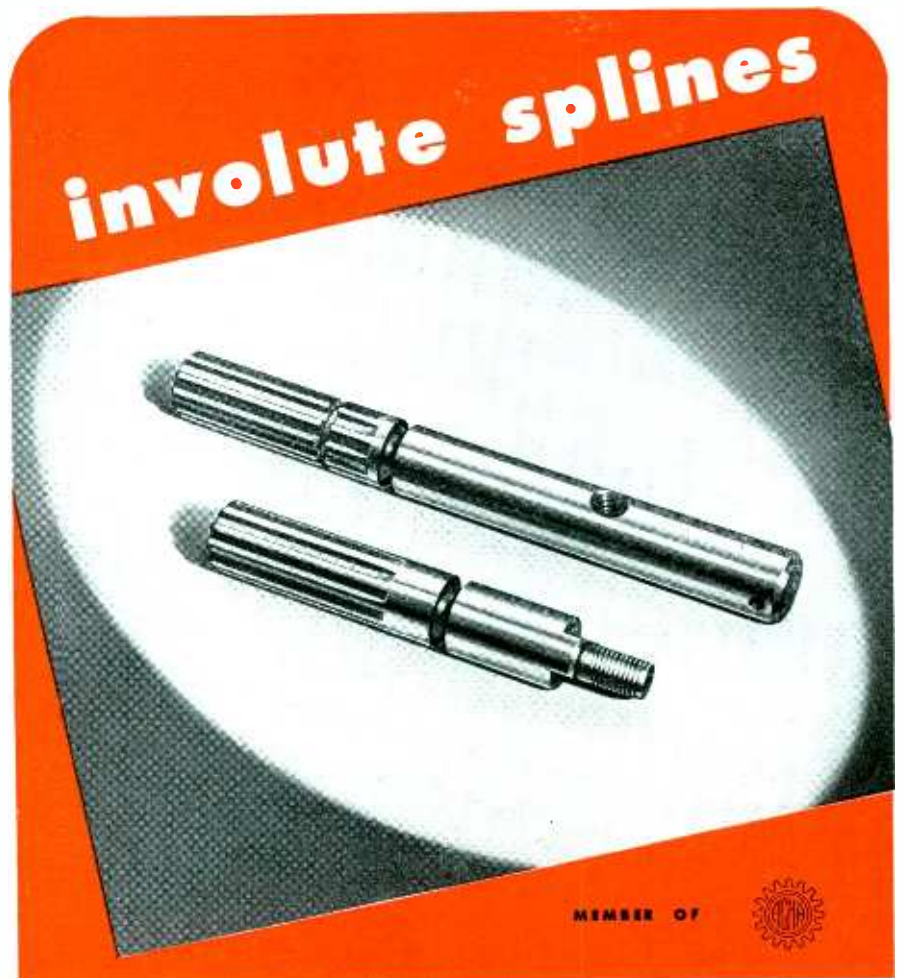

Precision-made gears . . . small and medium sizes . . . in standard and special tooth forms, from any kind of material, made to your exact specifications. Tolerances within .0005".

Beaver gears are used in well-known makes of modern products such as automobiles, radios, automatic tuning devices, phonographs, clocks, timing mechanisms, motion picture projectors, chronometers, gauges, optical equipment, instruments, machine tools, and many others.

Beaver engineers will design or redesign gears to meet performance and cost requirements. Send us your blueprints for estimate.

**SPURS • HELICALS • STRAIGHT BEVELS • SPROCKETS
RACKS • WORMS • WORM GEARS
THREAD GRINDING • COMPLETE GEAR TRAINS**

**Write Today for this
FREE BULLETIN**

Describes Beaver Gear's facilities and methods; also includes table of gear tooth parts.



Beaver Gear Works Inc.

1021 PARMELE STREET, ROCKFORD, ILLINOIS

The Truth About Electrical Contacts

IN theory, the perfect contact material should combine non-sticking properties, low contact resistance, high thermal and electrical conductivity and resistance to electrical erosion with high strength and hardness. In actual practice (because operating conditions differ widely) only two or more of these properties usually predominate.

How does Mallory vary the properties so the *right* ones obtain? You can be sure it isn't done by guesswork. Although Mallory has designed more than 5,000 different contacts—has had 20 years of experience in metallurgy generally—it believes in rigid control. This control is accomplished by a series of spectrographic, chemical, electrical and microscopic tests such as you see at the right. They reveal the truth about chemical composition, grain structure, physical properties.

Yes, you're *sure* when you order Mallory contacts. Furthermore, you get the benefit of Mallory design experience, its manufacturing facilities for producing *every* kind of contact including contact assemblies. What's more, Mallory has developed eight basic contact types that meet thousands of typical applications—save time and money involved in designing "specials." Send for the Mallory Contact Catalog.



This Mallory spectrographic device tests the purity of metals and alloys.



Here Mallory learns what happens in the electrical circuit when contacts are opened and closed.

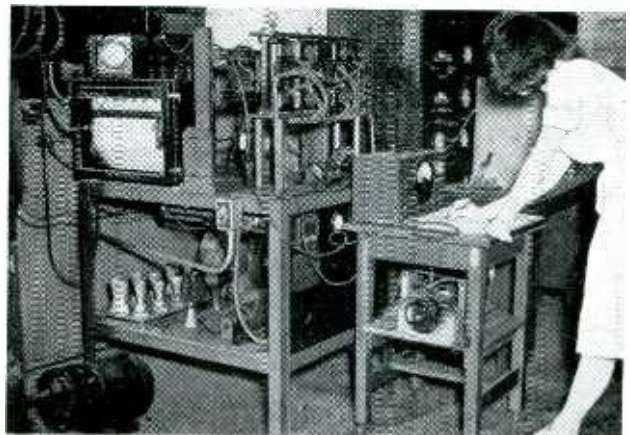

With this unit, Mallory technicians measure contact resistance and temperature rise.

P. R. MALLORY & CO. Inc.
MALLORY ELECTRICAL
CONTACTS & CONTACT ASSEMBLIES
P. R. MALLORY & CO., Inc., INDIANAPOLIS 6, INDIANA



CROSS TALK

► **JUKE** . . . Last month we rejoiced in Dr. Harry Olson's experiments (p 80, August) that proved that audiences like to hear popular music as played, without acoustic modification of the tonal range. But that was at Princeton. Now comes word from Minnesota that chills us to the bone. It seems that a bass viol player in one of the leading local dance orchestras approached the chief engineer of the Minnesota Electronics Corporation, asking for an amplifier system to be used with the orchestra. The specifications were usual in all but one respect. Said the viol player, "Build the amplifier so my bass viol will sound as loud as those you hear in the juke boxes. People are so used to the oomph, oomph of the boxes that they now squawk for it in the band!"

This is, to be sure, an isolated instance. But we hope we hear of no more like it. As an arbiter of musical taste we think an RC time constant is a very poor substitute for a bandleader's judgment. We rally to the Olson standard, while there is yet time.

► **TALK** . . . The late Professor Kenrick made quite a stir many years ago when he devised a gadget for attachment to a radio set which would silence the spoken word. It worked on any break in the modulation, such as occurs between words. Last month a Reuters dispatch from Johannesburg revealed that a South African gadgeteer had invented a similar device, but with a fiendish twist. His gadget automatically tunes in another station when the spoken word interrupts the program for more than a minute. Coming at a time when competition has reared its head in the broadcasting business as never before, this incident should remind us all that there's very little wrong with the broadcasting game that less talk (and better talk) wouldn't cure.

► **TELEBANK** . . . Firm in our resolve to keep our readers informed of new and interesting applications of television in the industrial and commercial fields, we have to report the Franklin Square (Long Island)

Bank. A television system between the teller's window and the bookkeeper department provides quick identification of check signatures. This saves the depositors' time, probably doesn't cost too much, and may stay in use for some time. But we'd like the story much better if it weren't for the fact that the same bank has a children's department with a low counter, and offers a lollipop to each child making a deposit. We understand they use a *miniature* image orthicon at *that* window.

► **HIGHBROW** . . . One of our staff, in recommending against publication of a paper dealing with operational calculus (on the score that few readers could follow it), delivered himself of an intra-office opinion which we think should arouse some argument. Our man claimed that only one percent of the members of our profession understand operational calculus, important tool that it is, well enough to use it in their work. Moreover he says, "Those in the saddle can expect to be displaced by young upstarts that come out of college knowing operational techniques and capable of using them. Moreover, the run-of-mine engineers in small companies cannot expect to compete, or enable their companies to compete, with the big operators who can afford a few of the highbrow boys to do this sort of stuff. What industrial and economic trends may be caused by this condition is anybody's guess." If this thesis is valid, and we think it is, it's food for plenty of thought. The number of practicing engineers who can use advanced calculus and vector analysis in the design of circuits and antennas is small, far too small in relation to the need for such ability. Will the older, less knowing group endanger their jobs or their companies' competitive position by speaking in cycles and decibels, rather than in Fourier transforms and dels? Maybe so. In any event, the future is for the bright young lads. The new crop just graduated, we hear, is a very superior grade of hombre, older than usual, more serious and better trained.

A MEMORY TUBE

Pattern is produced, stored, and scanned on dielectric screen by electron beams. Special cathode-ray tube can be used to store for protracted periods television pictures, radar indicator patterns, oscilloscope traces, or other information

By **ANDREW V. HAEFF**

*Naval Research Laboratory
Washington, D. C.*

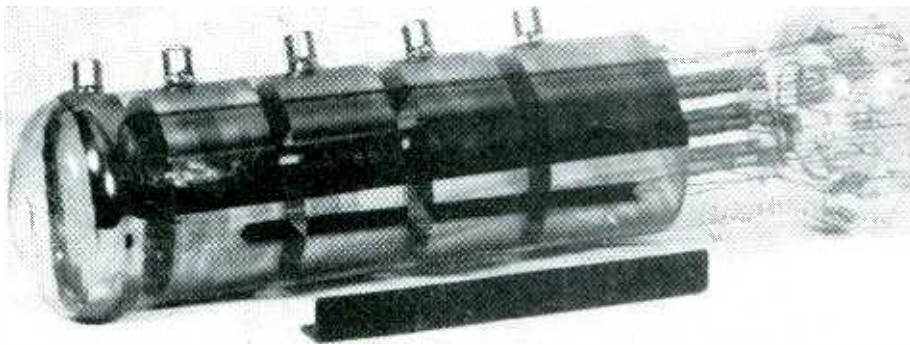

FIG. 1—By constant electronic bombardment, image is indefinitely retained on dielectric screen

AN ELECTRONIC TUBE having a controllable duration of image storage has been experimentally developed. The tube, shown in Fig. 1, can be used for rapidly recording electrical signals, storing them for any desired period, and simultaneous multiple reproduction of the recorded signals. Specific applications of this storage tube include use in simultaneous multicolor and three-dimensional presentation of radar or sonar data, daylight viewing, automatic recording and reproducing electrical transients, and storing and reading binary numbers of electronic digital computers.

Storage of Charges

Operation of the tube is based on secondary emission properties of a dielectric target bombarded by electrons. Three electron beams of different energies scan the target.

One beam writes or paints the stored image or picture, another holds the recorded information, and the third reads or electrically reproduces the recorded information.

A pattern of charges deposited on the surface of a good insulator can be retained for a long period. Deterioration of the pattern or electrical picture finally occurs from leakage of the charges over the surface and through the body of the insulator, or due to irradiation of the surface, either by a corpuscular beam (with associated secondary emission effects) or by electromagnetic waves (photoemission and photoconductivity). Leakage effects can be minimized by using a dielectric of extremely high resistance.

If it is desired to generate electrical signals which correspond to the stored-charge pattern, it is necessary to explore the surface of the

dielectric point by point. This is most conveniently done by scanning the surface with a focused electron beam. This process, however, usually results in a complete erasure of the stored picture after a few scans, as is commonly observed in television pickup tubes.

In the novel storage tube here described, the effect of erasure is completely neutralized by constant bombardment of the surface by a stream of electrons of suitable energy, thereby continuously regenerating the picture. Thus the picture can be retained for any desired period of time, even though it is being continuously scanned in order to obtain electrical output.

A schematic representation of the basic memory tube is shown in Fig. 2. The cathode-ray type tube must have at least two independent sources of electrons and a suitable

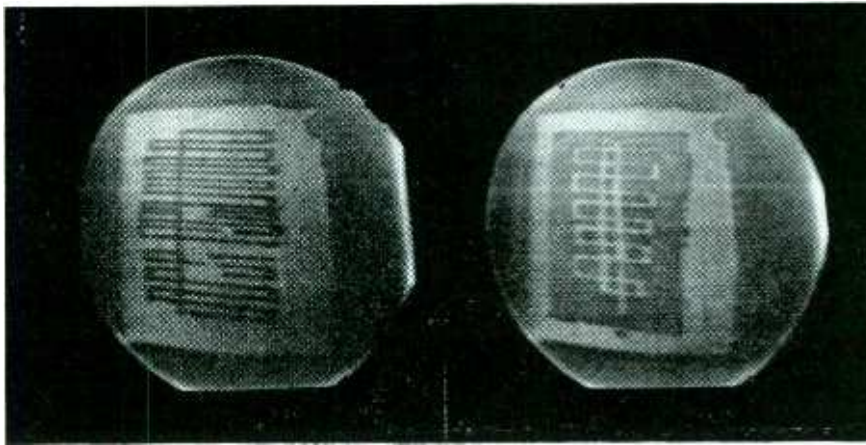

Depending on relative tube voltages, writing can be either black on white or white on black

Using potentiometers controlled by position of writing stylus to produce vertical and horizontal deflection signals, pattern can be traced stroke by stroke and all lines forming the writing or picture are retained by screen

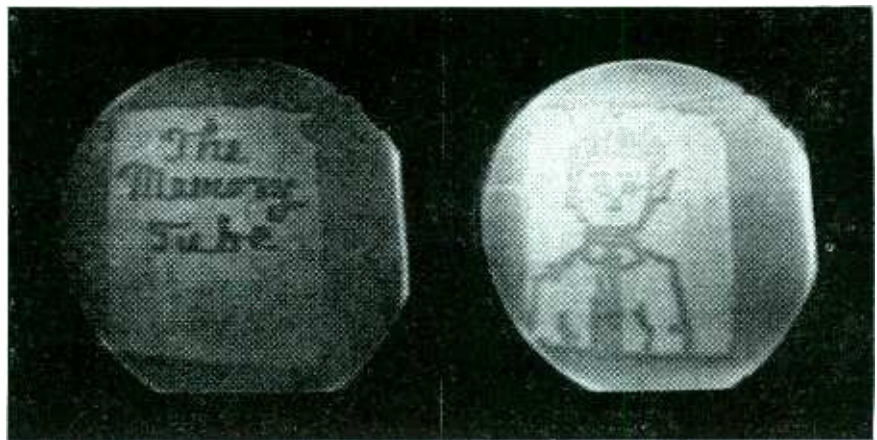

dielectric target on which the charge pattern can be stored. In front of the target is a metal screen or collector. The velocity of the electrons while passing the screen and approaching the target is determined by the potential difference between the screen and the particular cathode from which the electrons originate. The electron beams will be referred to as the writing, holding and reading beams.

Functions of Beams

Writing is done with a focused beam of relatively high current density. This beam writes the desired electrical picture by being directed through a deflection system to different parts of the target and by being modulated either in intensity or velocity. The elements of the target explored by the writing beam either lose or accumulate elec-

trons and thus assume a potential different from that of the unexplored part of the target surface.

The function of the holding beam is to retain the painted picture for a desired period of time by spraying the entire area of the target with electrons of suitable velocity and in sufficient numbers. This holding can be accomplished either by a diffused beam bombarding the whole surface simultaneously or by a focused beam which scans the surface in a selected time sequence.

The reading beam is a focused beam of constant intensity that scans the dielectric surface. In bombarding the target surface, the reading beam generates secondary emission current, the instantaneous magnitude of which depends upon the potential of the particular element of the target being scanned at that moment. This secondary cur-

rent is partially intercepted by the metal screen in front of the dielectric target. Thus the current flowing to this metal screen constitutes the electrical output of the device. The output current is fed through a suitable amplifier to the grid of a conventional cathode-ray indicator tube, the electron beam of which is made to scan in the same manner as the reading beam of the memory tube. The intensity modulation of the scanning beam of the indicator tube is converted into light-intensity variation over the surface of the cathode-ray screen, and thus the electrical picture painted on the surface of the storage tube target becomes visible on the face of the indicator tube.

Target Characteristics

The mechanisms of writing, holding, and reading are based on the

secondary-emission properties of the target. Figure 3A illustrates a typical characteristic of a dielectric surface under bombardment by electrons. At low primary energies (when the incident velocity is less than that corresponding to the critical voltage) the net current to the target is negative, so that the target element bombarded by low velocity electrons tends to accumulate electrons and thus to assume a more negative potential. At the critical voltage, corresponding to unity secondary emission ratio, the net current to the target is zero because as many electrons leave as arrive. At higher energies the net current to the target is positive.

If the potential of the collector is below the potential of the target element, then the secondary electrons, under the influence of the retarding field of the collector, will be returned to the target surface. On the other hand, the secondary electrons flow to the collector where its potential is higher than the target potential. The net current to the target element as a function of its potential can be represented as is shown in Fig. 3B.

When a stream of electrons is directed towards the target surface, any element of the target which has a potential below critical value tends to accumulate a negative charge and will finally reach the cathode potential. Any element charged to a potential above the critical value will tend to approach the potential of the collector. Thus the cathode and the collector potential are two stable points at which the target elements can maintain themselves under continuous bombardment by a stream of electrons. Any tendency to lose the charge, due either to leakage of the dielectric or to bombardment from other sources, will be opposed by bombardment from the first source. This characteristic is made use of in the memory tube for maintaining the painted picture for any desired period of time.

Producing the Image

To paint the electrical picture, the target is scanned with a focused electron beam from a separate cathode and at such velocity and current density that it can override

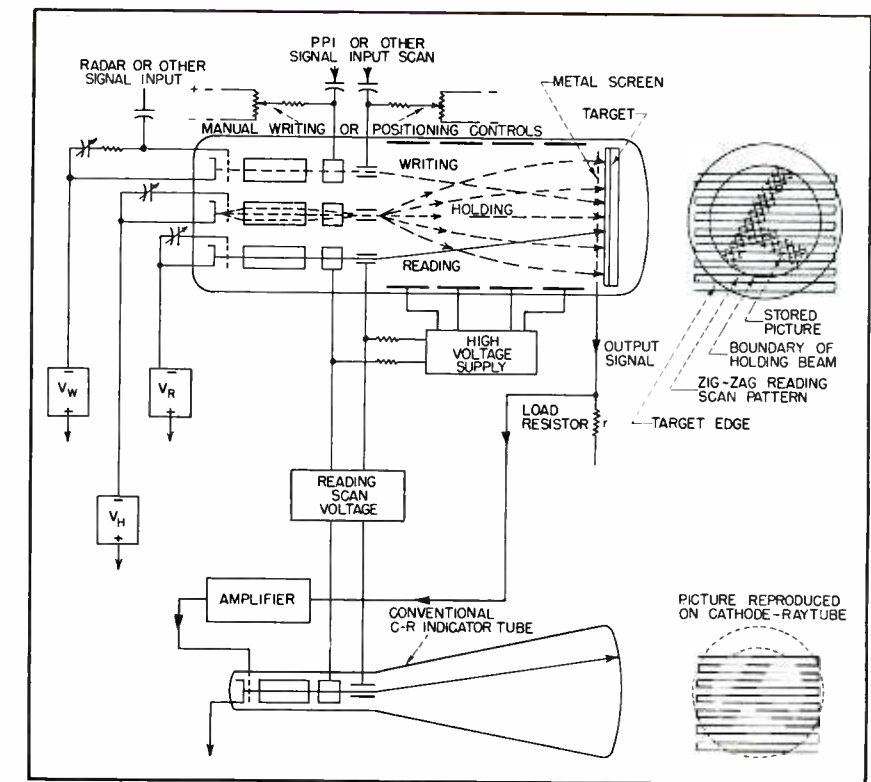

FIG. 2—Memory tube stores picture which can later be reproduced on other cathode-ray tubes

the tendency of the holding beam to maintain the potential distribution over the target surface. As the writing beam is moved over the surface, it leaves a trace which assumes collector potential. When the target surface has luminescent material deposited on it, the positively-charged trace of the writing beam becomes continuously visible under bombardment by the holding beam. The remaining portions of the target remain dark because only the positive areas of the target are bombarded by electrons of sufficient energy to excite the phosphor. This process of painting the electrical picture is referred to as analogous to writing with white chalk on a blackboard.

If the cathode producing the writing beam is maintained at a potential below the collector potential by an amount less than the critical energy, the target elements under its bombardment tend to change their potential in the negative direction. Thus, if the surface of the target was originally charged to the collector potential, the writing will appear in the form of dark lines. This painting is analogous to writing with a black pencil on white paper. Thus by the use of a

suitable phosphor on the target surface, it is possible to observe the electrically painted picture directly on the target of the storage tube. In spite of the relatively low electron velocities thus far employed in tests, the picture can be made sufficiently bright with moderate currents because the bombardment and luminescence take place all of the time.

Electrical Output

For many applications it is convenient to obtain electrical signals from the memory tube that correspond to the stored picture. Then the picture can be reproduced in television fashion on the face of any number of conventional indicator tubes.

To obtain electrical output from the memory tube, a third electron beam is used. It scans the surface of the target in television fashion or in the zig-zag pattern shown in Fig. 2. Velocity of the electrons of the reading beam is relatively high, thus their bombardment of the surface produces appreciable secondary emission current from the target. The reading beam is adjusted to give maximum signal output without disturbing the potential

distribution on the target surface, which has some areas at the potential of the collector and some at the potential of the cathode of the holding beam.

This process of reading is analogous to scanning the target of a monoscope tube used in television. The net secondary current flowing from positive areas is different from the current flowing from negative areas so that scanning of the areas by the reading beam produces variations in current to the collector electrode. These current variations are converted into voltage variations in the load resistor and, after suitable amplification, are used to modulate the beam of a conventional indicator tube, which reproduces the picture in television fashion.

If the velocity of the reading beam is adjusted to a value required for the holding beam, then the continuously scanning reading beam can perform the holding and the reading functions simultaneously. For this method of operation only two guns are needed, one for writing and one for holding and reading.

Image Resolution and Stability

High stability of the image, and high signal output were obtained by operating the tube in either the two-beam or the three-beam mode. With writing beam currents of the order of microamperes, and the beam diameter of the order of one millimeter, the writing speed is of the order of several kilometers per second. An increase in current results in a corresponding increase in writing speed. Thus it is possible to record very fast transients even with moderate beam currents.

The number of discrete elementary areas which can be resolved on the storage tube target is determined primarily by the spot diameter of the writing beam. It is expected that with well focused beams about 10,000 elements can be resolved.

Because differences of potential between positive and negative elements of the target are of the order of a hundred volts, corresponding differences in secondary emission currents are quite high. Thus, scanning the target by the reading beam

produces current variations of the order of the reading beam current itself. With a load resistance of the order of 1,000 ohms, a signal output of the order of several millivolts is obtained with the reading-beam current of several microamperes, so that a simple amplifier of rather low gain can be used satisfactorily.

High resistivity of the target material contributes to a very high stability of the electrical image. It is possible to observe the image, which is continuously scanned by the reading beam, for hours without noticeable deterioration of detail. This stable condition is realized over a considerable range of current densities and electron velocities of the holding beam. If the potential of the holding beam cathode exceeds the value corresponding to the condition of stable operation, excessive potential gradients along the dielectric surface, in the regions of transition from positive to negative areas, result in spreading of the positive areas over the rest of the target surface. On the other hand, when the holding beam velocity approaches the critical value, the positive areas tend to shrink and the picture is gradually washed away. Lowering the holding beam velocity below the critical value makes it possible to erase the picture rapidly. A suitable adjustment of the holding beam velocity thus

makes it possible to obtain the desired persistence of the image; in other words to control the effective memory of the device. Several other methods of control of memory, such as pulsing of the holding beam in a specified manner, also appear promising. The adjustable persistence rather than infinite persistence is extremely useful for such applications as radar target presentation where it is desirable to plot automatically the track of the moving target for a specified time so that the length of the track will be proportional to the velocity of the target. This development thus presents a promising solution of the problem of controllable persistence which has not been solved by development of special phosphors.

In studying the operation of the memory tube under different conditions it was observed that, in addition to the normal mode of operation which is explained on the basis of the secondary emission characteristics, it is possible to operate the tube under several different conditions. This observation indicates the existence of additional stable points and a rather complex nature of the secondary emission characteristic.

Other interesting effects, such as generation of charge waves propagating over the surface of the target at rather low speeds, appearance of scintillations or brightly lighted spots apparently associated with ion bombardment, and other effects, were observed in connection with this study. Their description lies beyond the scope of this paper but their mention is intended to stimulate interest in the use of the memory-tube technique for general studies of the secondary emission and other properties of dielectrics.

The author takes this opportunity to express his appreciation of the many contributions of his colleagues and assistants in this project, Mr. F. H. Harris and Dr. S. T. Smith, who by their enthusiasm, resourcefulness and industry helped to achieve the successful solution of many difficult problems which were encountered in the course of this study, and to thank the other members of the Laboratory who gave their whole-hearted cooperation in this project.

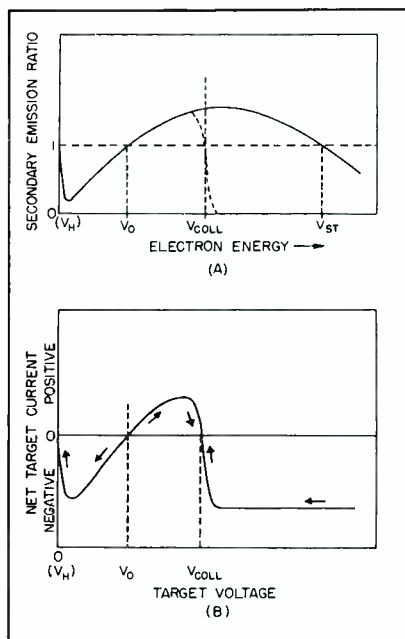

FIG. 3—Secondary emission phenomena give the dielectric target its required characteristics

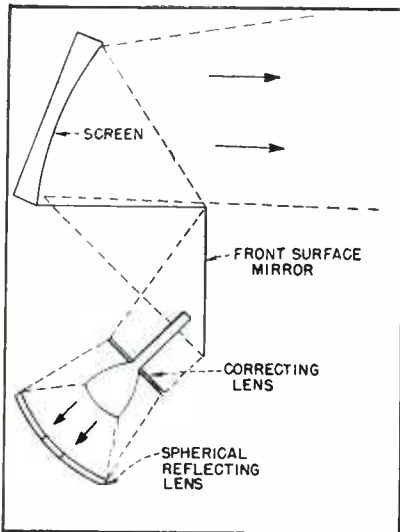

FIG. 1—Elements of the projection system, viewed from the side of the cabinet

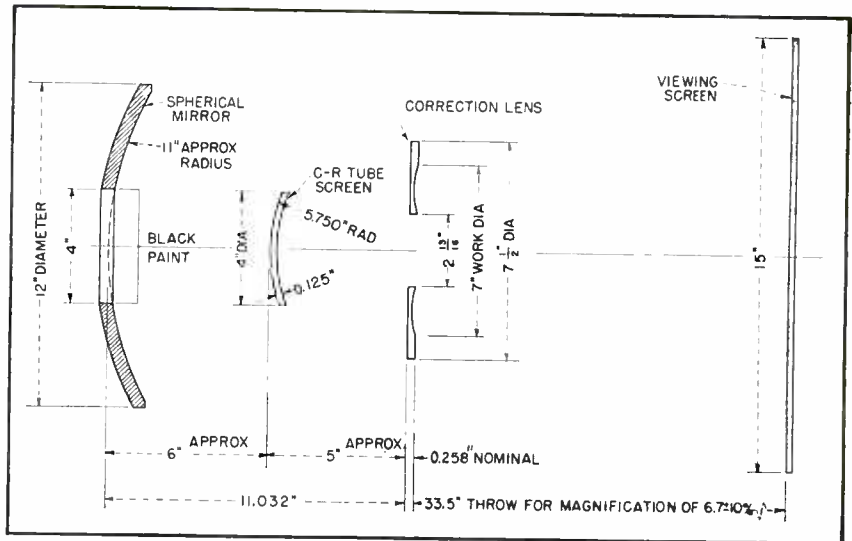

FIG. 2—Dimensions of the Schmidt projection system, arranged for rectilinear throw

A New Television PROJECTION SYSTEM

Combination of a Schmidt optical system, a new phosphor, directional viewing screen, keystone projection, and ingenious cabinet arrangement produces a 15 by 20-inch picture of exceptional brightness and contrast

By **WILLIAM E. BRADLEY** and **ERNEST TRAUB**

Director of Research *Project Engineer*
Research Division, Philco Corporation
Philadelphia, Pennsylvania

EARLY this year, members of the Federal Communications Commission¹ saw a developmental model of a new television receiver, producing a projected picture of unusual brightness and contrast, and having great resistance to the effects of external light. This receiver, developed by Philco Corporation engineers, has now reached the production stage and was announced to the trade in June as model 2500.

The receiver produces a picture 15 by 20 inches in size, of excellent brightness and contrast. The area contrast of the picture is approximately 70 to one, and the picture may be viewed without loss of contrast in an ambient light level of well over 100 footcandles (such as

is produced in a living room by direct sunlight through several unshuttered windows). This exceptional performance is made possible by a new projection technique described in this paper.

The elements of the projection system are shown in Fig. 1, which represents a side view of the cabinet. The 4-inch projection tube produces on its screen an image, about 2½ by 3 inches in size, with a high-light brilliance of about 2,000 foot-lamberts (aluminum-backed tube). The light is collected by the front-surface spherical mirror which reflects it through the correction lens. This lens removes the spherical aberration introduced by the mirror and passes the corrected image to the front-surface

mirror on the inner surface of the cabinet. This in turn reflects the image to the under side of the cabinet lid, which is covered with a directional viewing screen of unusual construction.

The screen confines the major portion of the light, reflected forward to the audience, to a solid angle 60 degrees wide by 20 degrees high. This beam-projection system introduces an optical gain of some 10 times relative to a perfectly diffusing screen, with corresponding increase in brightness. Great care has been taken in the cooperative design of the optical system, including the screen, to eliminate the formation of a dark central zone in the viewing area, from which the picture cannot be viewed properly.

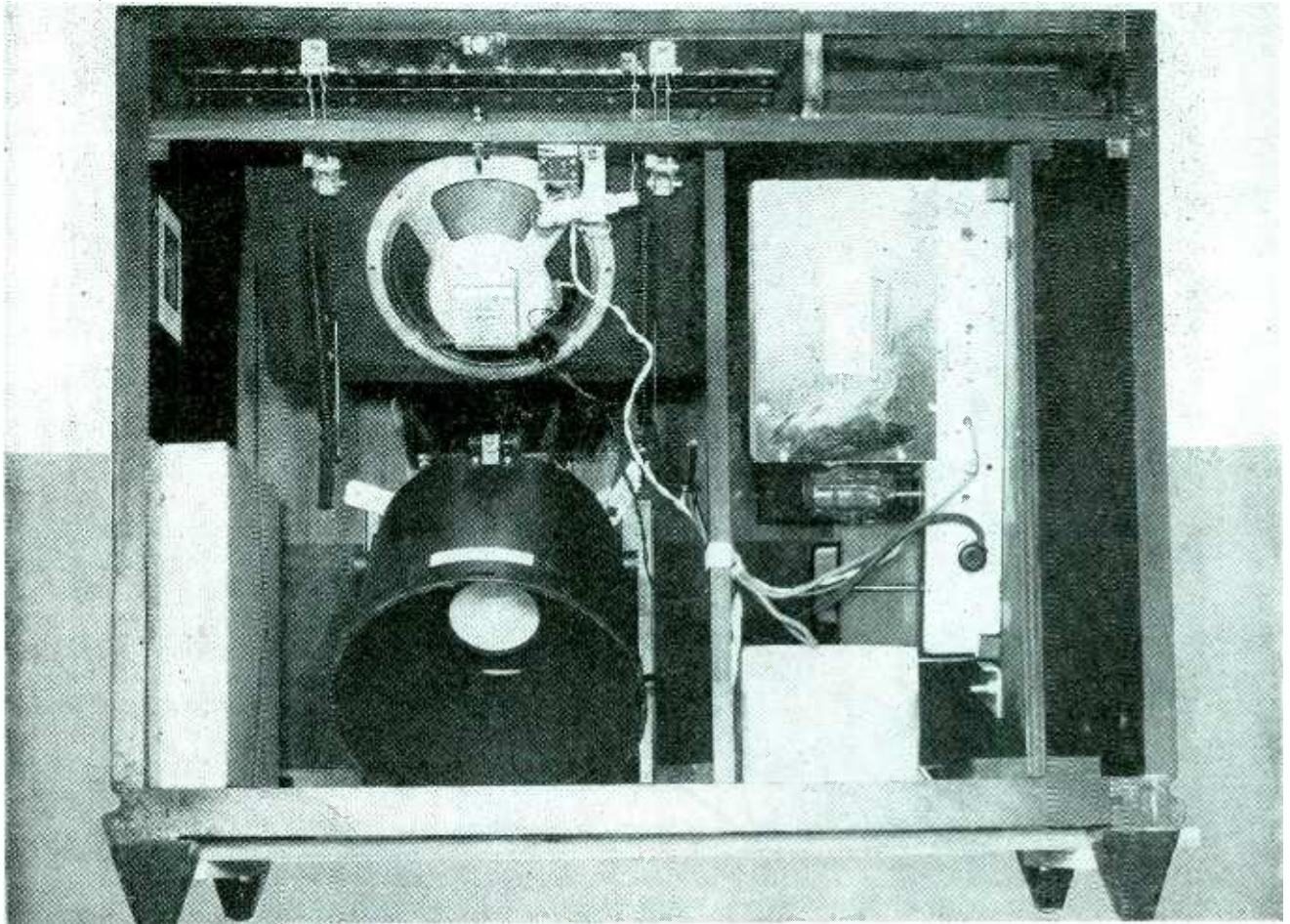

Rear view of Philco model 2500 projection receiver, with spherical mirror removed from housing (lower left). The chassis at right tunes eight stations, contains 29 tubes

This zone has been one of the principal objections to systems employing a directional screen and a centrally vignettted light source. The screen is also designed to reflect a negligible amount of light which may fall on it from the surroundings, so the contrast of the image is preserved even in a brightly-lighted room.

Inspection of Fig. 1 shows that the optical distance from the screen of the c-r tube to the top of the viewing screen is somewhat greater than the corresponding distance from the tube to the bottom of the screen. Thus, if the image on the face of the c-r tube were rectangular, the image viewed on the screen would be wider at the top than at the bottom. To correct

this geometric distortion, a compensating geometric distortion of the image is produced on the c-r tube. This system, as described later, employs fixed magnetic deflection elements near the c-r tube, and does not involve any modification of the deflection circuits, which are those that would produce a conventional rectangular pattern. In addition, compensating corrections of the optical system need to be incorporated.

Details of System

Details of the elements of the projection system (projection tube, Schmidt system, viewing screen and keystone projection system) are described below.

The projection tube screen has

a four-inch diameter face, and a radius of curvature of 5.75 inches, with a thickness of 0.125 inch. The tube operates at 20 kilovolts. It employs a new phosphor which produces a truly black and white picture when operated at the correct anode voltage. Moreover, the color of the fluorescence is independent of beam current, so the picture does not display the characteristic yellow tinge in the highlights, typical of earlier projection tubes. Screens both with and without aluminum backing have been produced. The aluminum-backed tube gives greater brightness and contrast at the 20-kilovolt level, and is now being used in production.

The electron gun of the tube operates with an average beam cur-

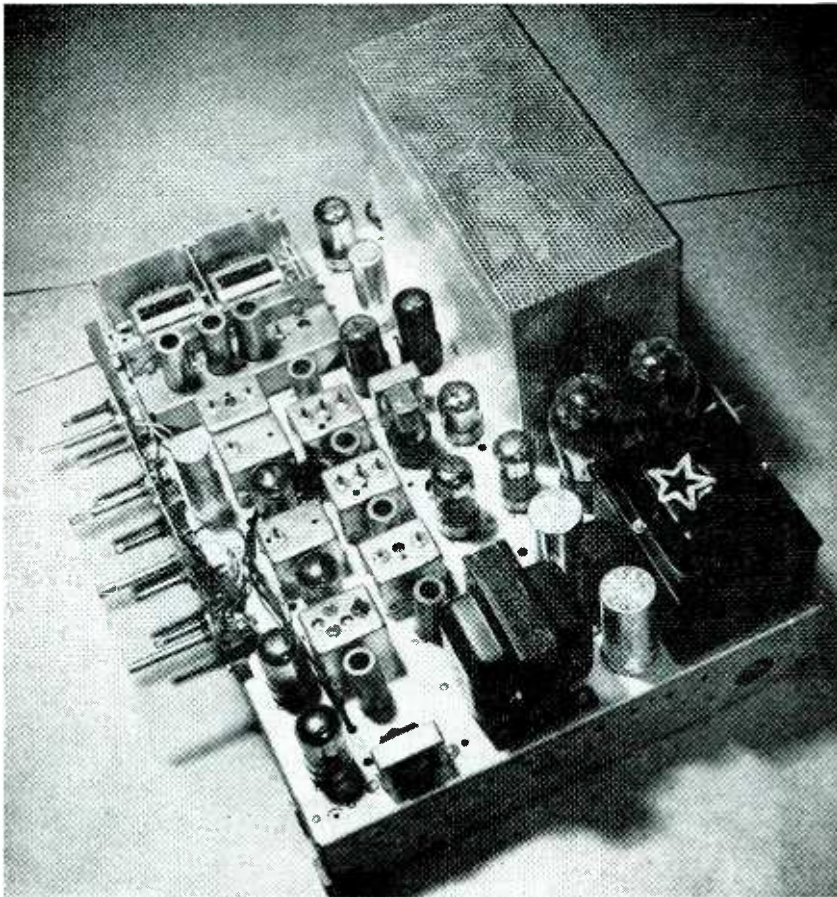

Chassis of the projection receiver, showing the rotary mechanism of the station selector (top, left). The receiver contains 29 tubes

rent of 80 microamperes, with 600 microamperes peak in the highlights. It requires a swing of approximately 80 volts. The beam cuts off at $-100 \text{ volts} \pm 30 \text{ volts}$.

Wide Aperture Optics

The dimensions of the modified Schmidt projection system are shown in Fig. 2, arranged in the conventional rectilinear form. The action of the correction lens can be seen from Fig. 3 and 4. The point O , on the surface of the c-r tube screen emits light along the typical rays 1, 2 and 3. After reflection from the spherical mirror these rays follow the paths 1', 2' and 3'. If these rays continued without correction they would impinge on the optic axis at widely differing points A , B , and C . Consequently at the image plane I the point object O would be reproduced as a circle of light. This defocusing, an effect known as spherical aberration, can be removed by the correcting lens.

The correcting lens is so formed and positioned that a reference ray,

say number 2, passes through it undeflected, reaching the optic axis at the image plane I . A ray closer to the axis, say number 1, passes through a portion of the correcting lens having positive curvature and so is bent toward the axis along the path 1', falling on the axis at I . Another ray, say number 3, further from the axis, passes through a portion of the correcting lens having negative curvature and so is bent outward along ray 3', reaching the axis also at I . Hence all rays starting at the point O come to focus at the same point I . If other points of the c-r tube screen are arranged along a curved surface, as in Fig. 1, the resulting image lies in a flat surface. Theoretically the surface of the c-r tube screen should be an ellipsoid, but in practice a spherical surface suffices.

The correcting lens may introduce other aberrations of its own, but by using a lens of low power, the aberrations may be kept negligibly small. It must be remembered that the 525-line television image is,

in itself, rather coarse-grained compared to the images usually met in projection systems, so that the allowable defocusing and other aberrations in the projection system are greater than they would be if the image had finer detail.

Calculations show that the radius of curvature of the c-r tube screen should generally be 0.53 times the radius of the mirror. In the Philco system, these radii are 11 and 5.75 inches respectively. The throw of the system (distance from the correcting lens to the viewing screen) is 33.5 inches. The Schmidt system is one which must be designed for a particular value of magnification.

The efficiency of the optical system is here defined as the fraction of the total light flux emitted by an element of the c-r screen at the center, which the optical system accepts and focuses on the corresponding point of the image. The efficiency is equal to $\sin^2 u$, where u is the semi-apex angle shown in Fig. 3. The corresponding f /number of the lens is $1/(2 \sin u)$. The f /number of the system must be used with caution, however, in comparing the system with a lens, since a portion of the center of the spherical mirror is masked off (actually painted black to reduce halation) because light reflected from this region is blocked by the c-r tube.

In this particular system the efficiency is about 30 percent, taking into account the central masking. The corresponding f /number is $f/0.8$ and the linear magnification 6.7 times. The actual dimensions of the c-r tube image are 2-1/16



Projection mechanism

inches high by 2-9/16 inches wide at the top and 2-31/32 inches wide at the bottom. When magnified by a mean value of 6.7, these dimensions become 15 by 20 inches, as viewed by the audience on the screen.

Keystone Correction

The relative positions of the various parts of the system are shown on Fig. 4. To produce proper focus over the area of the image, the tube axis is placed at an angle β to the optic axis, such that $\tan \beta = m \tan \alpha$ where α is the angle shown in Fig. 4, and m is the reciprocal of the magnification. In the Philco system, α is $24^\circ 30'$, β is $3^\circ 54'$ and m is 1/6.7.

As previously mentioned, when the projection system is placed in the cabinet as in Fig. 1 the unequal distances between top and bottom of the viewing screen and the c-r tube produce geometrical distortion. To correct the distortion, the scanning pattern on the screen of the c-r tube must have a trapezoidal shape, as shown in Fig. 5. This shape might be introduced by modulating

the amplitude of the horizontal scanning wave (this is the technique used in conventional iconoscope cameras), but a simpler system was devised using magnetic pole pieces at the edges of the c-r tube screen. The arrangement is shown in Fig. 6. Two bar magnets are fixed to opposite sides of the tube. Two pole pieces A produce lines of flux across the tube, just inside the screen. These lines are essentially straight and parallel. They cause the scanning beam to be deflected sharply upward just before it hits the phosphor. Consequently the scanning pattern is laid down on the phosphor at an angle and its shape, when projected on the tube face, is trapezoidal.

The sharp deflection imposed on the scanning pattern causes the pattern to fall on the screen in an off-center position. This is corrected by a supplementary magnetic field, produced by the fringing field between the "point" poles B at the opposite ends of each magnet. The flux lines of this field are curved, and they are opposite

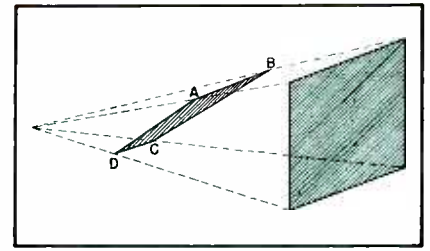

FIG. 5—Projection of a trapezoid at an angle produces a rectangular image, correcting keystone distortion introduced by folded geometry of projection system

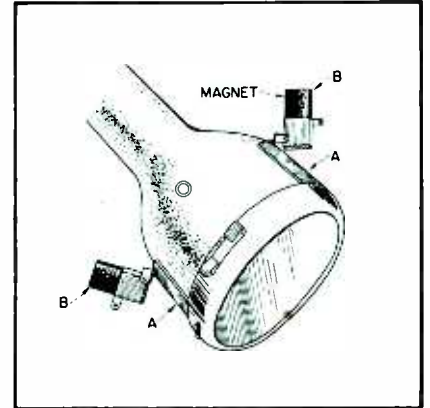

FIG. 6—Bar magnets and pole pieces for producing trapezoidal pattern on c-r tube screen

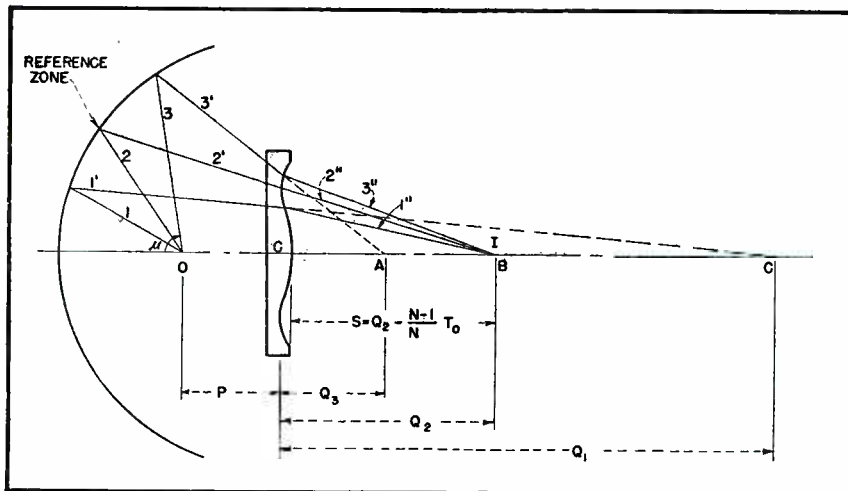

FIG. 3—Correction of spherical aberration caused by spherical mirror

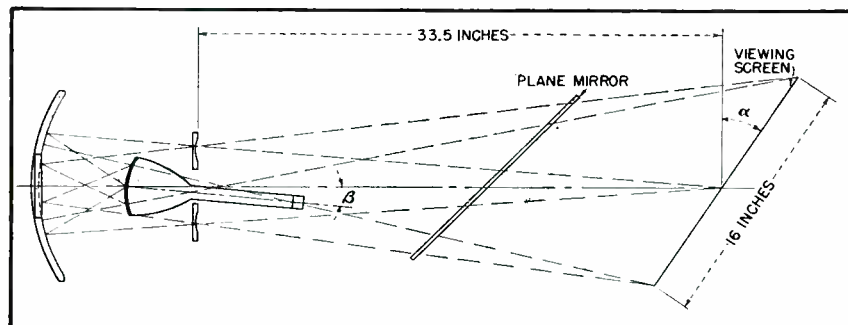

FIG. 4—Geometry of projection system when plane mirror is introduced to permit installation as in Fig. 1

in direction to, as well as weaker than the lines produced by the pole pieces A. Each field produces curvature and displacement in addition to the keystone. By adjusting the angle of each bar magnet, the curvature and displacement are cancelled, while the necessary amount of the keystone correction remains.

Independent adjustments of the position of the cathode-ray tube are provided axially and about two axes perpendicular to the optic axis. These adjustments permit sharp focus to be obtained within the range of magnifications for which the optical system is designed.

Viewing Screen

The high brightness and contrast of the image are accounted for by the viewing screen on which the image is projected, and its inclination. Conventional viewing screens, such as are employed in motion picture houses, are non-directional, that is they reflect an equal amount of light flux in all directions. Such screens are suitable if the incident light is very bright, and if it is

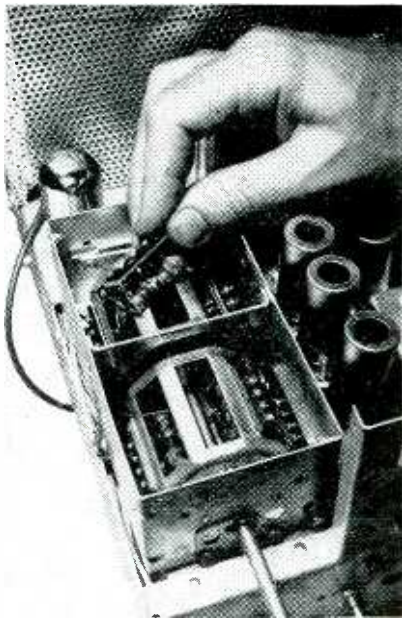

Closeup view of turret switching arrangement used for station selection in the receiver

required to supply equal brightness to all viewers regardless of their position relative to the screen. But since television receivers must often be operated in brightly-lighted rooms, it is important to conserve light. This can be done by imparting a directional characteristic to the viewing screen.

Light Distribution

A typical Rousseau diagram of a directional screen is shown in Fig. 7, together with the light distribution as a function of the angle. This ideal screen radiates equal flux within a 20-degree vertical angle and a 60-degree horizontal angle. The reflected picture is invisible outside these limits, but is equally bright wherever viewed within them.

The choice of the angular dimensions of this ideal screen is based on statistical studies of Professor Hooton of Harvard University carried out for the Army Air Forces. In this study the anatomical statistics of male and female pilots were studied to determine their seated heights. This information, combined with tests to determine the optimum height of a television viewing screen above the floor, leads to the conclusions that the viewing space can be compressed to a 20 by 60-degree solid angle. If all the light impinging on a screen is reflected in such a pattern, the image

will be 17.2 times as bright as if reflected from a perfectly diffusing, nondirectional surface.

Since the desired beam is wider than it is high, it is not possible to use symmetrical optical elements, such as small glass beads, to produce the beam. The asymmetrical nature of the pattern also makes it possible to introduce another important property, namely to reduce the susceptibility to the effects of external light. Light entering the system from sources outside the reflected beam is not reflected back to the audience, and the picture thus retains its contrast even when viewed in a high ambient illumination.

The actual directional characteristic of the Philco screen is shown in Fig. 8. The major portion of the illumination, as shown in the Rousseau diagram at the left, is contained within plus or minus 10 degrees vertically and 30 degrees horizontally, producing an overall projected beam 20 degrees high by 60 degrees wide. The illumination drops substantially to zero at plus or minus 15 degrees vertically and plus or minus 60 degrees horizontally. Tests with this distribution have shown it to be thoroughly adequate for living-room use.

Construction of Screen

The screen consists of a curved sheet of metal, formed as a section of a cylinder of 60 inches radius. This is fitted under the lid of the cabinet with the axis of the cylinder horizontal. On the surface of the screen are many thousands of vertical grooves. These grooves

have a random distribution of sizes and cross-sections, but the net result is as if they had cross-sections in the shape of minor arcs of circles. The curvature of the surface tends to confine the reflected light into a narrow beam, measured vertically, while the grooves tend to spread the light over a horizontal sector measuring some 60 degrees. The radius of curvature of the surface is twice the product of the projection throw and the viewing distance, divided by the sum of these distances.

One objection to the use of such a reflecting surface, when an ordinary lens system is used, is that the beam is confined excessively in height. When a Schmidt optical system is used, the light spreads through a wider vertical angle, but another difficulty arises. This is the formation of a dark spot at the center of the screen, due to the fact that the effective light source is a correction lens of annular shape (no light comes from the center of the source). Although each point of the correction lens illuminates the whole viewing screen, the relative directions and angles of the rays from correction lens to screen are such that each elemental area of the picture is lacking in rays directed toward the central zone of the viewing area. Hence if one views the screen from a point on the optic axis the picture appears dark, with somewhat greater illumination toward the edges. If the picture is viewed at a point sufficiently removed from the optic axis, it appears uniformly illuminated. Since the optical power of the

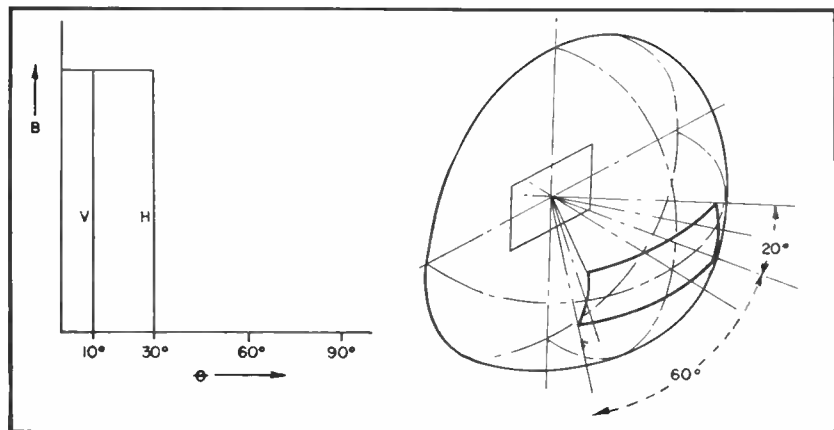

FIG. 7—Rousseau diagram (left) and angular distribution of ideal beam-projection directional viewing system, having a gain of 17.2 over a perfect diffusing surface

Phileo system is not equal in both coordinate directions, the dark spot is not circular. It is, rather, elongated horizontally throughout the width of the viewing area, and it possesses appreciable illumination, although distinctly less than the top and bottom areas.

This rather serious defect of the system has been overcome by covering the viewing screen with many millions of lens-like hemispherical droplets, each of which redistributes the light falling on it throughout a narrow predetermined angle. The angle, by suitable choice of the size and refractive index of the droplets, causes each elemental reflection to spread out so that it reaches the central region of the screen, which would otherwise remain under-illuminated. The droplets thus diffuse the light, but by an amount small compared with that produced by the vertical grooves. Hence the tendency to increase the width of the beam in the horizontal direction is negligible.

The droplets are formed by applying a lacquer, of proper index of refraction, in a fine mist-like spray. To keep each droplet distinct and separate from its neighbors, several incomplete sprayings are applied, with time between each to permit drying. Hence one set of droplets does not coalesce to those previously applied.

Cabinet and Chassis

A side view of the chassis with principal dimensions is shown in Fig. 9. One important item in the arrangement is the loudspeaker, which is so positioned with respect

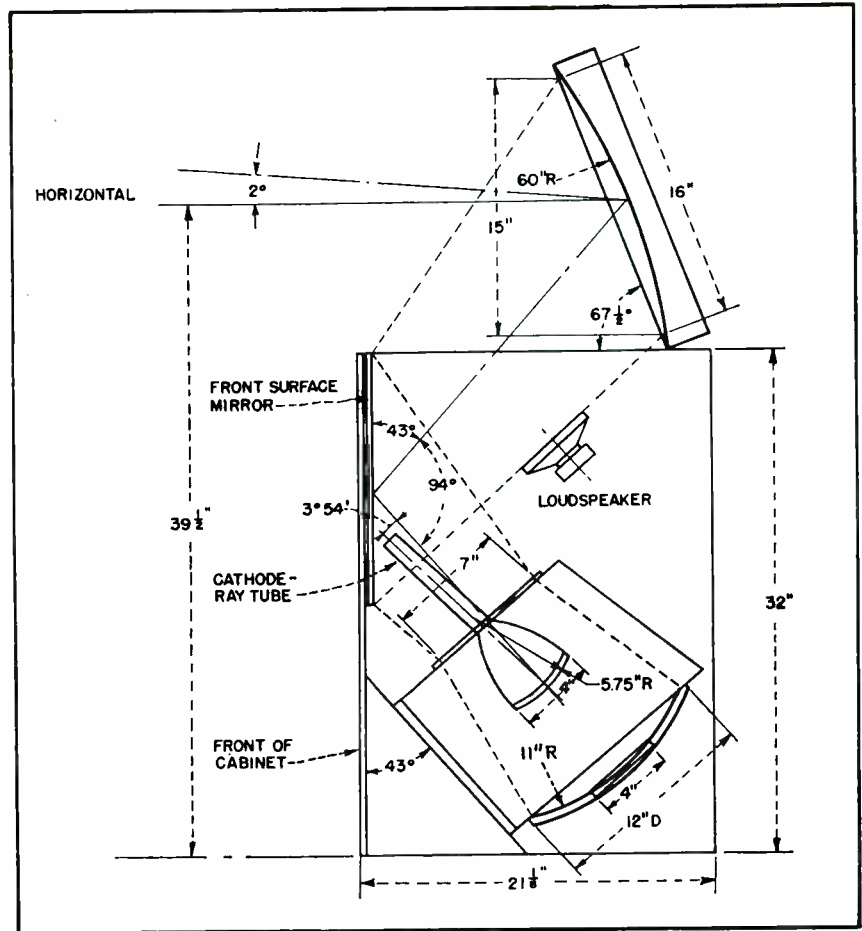

FIG. 9—Dimensions of the projection system, as viewed from side of cabinet. Loudspeaker is located close to center of image, adding to realism

to the viewing screen that sound reflected from it appears to emerge directly from the center of the screen. This assists materially in creating the illusion of reality. To maintain the elements of the optical system in proper relation, it is essential that the lid of the cabinet be raised to the precise angle of proper inclination and remain in that position rigidly. This is ac-

complished by a rugged spring-loaded elevating mechanism with a positive stop.

The electrical system of the receiver includes 29 tubes, five of which are rectifiers. Five manual controls are provided, for station selection, contrast, brightness, volume, and tone. Provision is made for eight r-f channels, installed at the factory to meet the particular situation in each major market. The i-f bandpass is approximately 4.0 mc, and the sensitivity is approximately 100 microvolts for a solidly synchronized picture. Automatic gain control is provided in the picture circuit. One unusual electrical feature is a stabilized synchronization circuit which, in addition to maintaining sync in high noise level, eliminates nonlinear scanning and defocusing of the beam.

REFERENCES

- (1) FCC Views Television Advances, *ELECTRONICS*, p 80, March 1947.
- (2) Maloff and Epstein, Projection Television, *Jour. S.M.P.E.*, June 1945.
- (3) Maloff, and Epstein, Reflective Optics in Projection Television, *ELECTRONICS*, p 98, Dec. 1944.

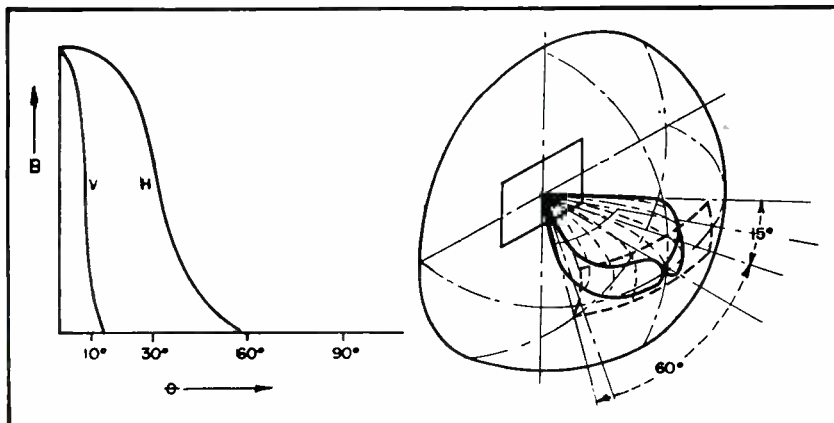
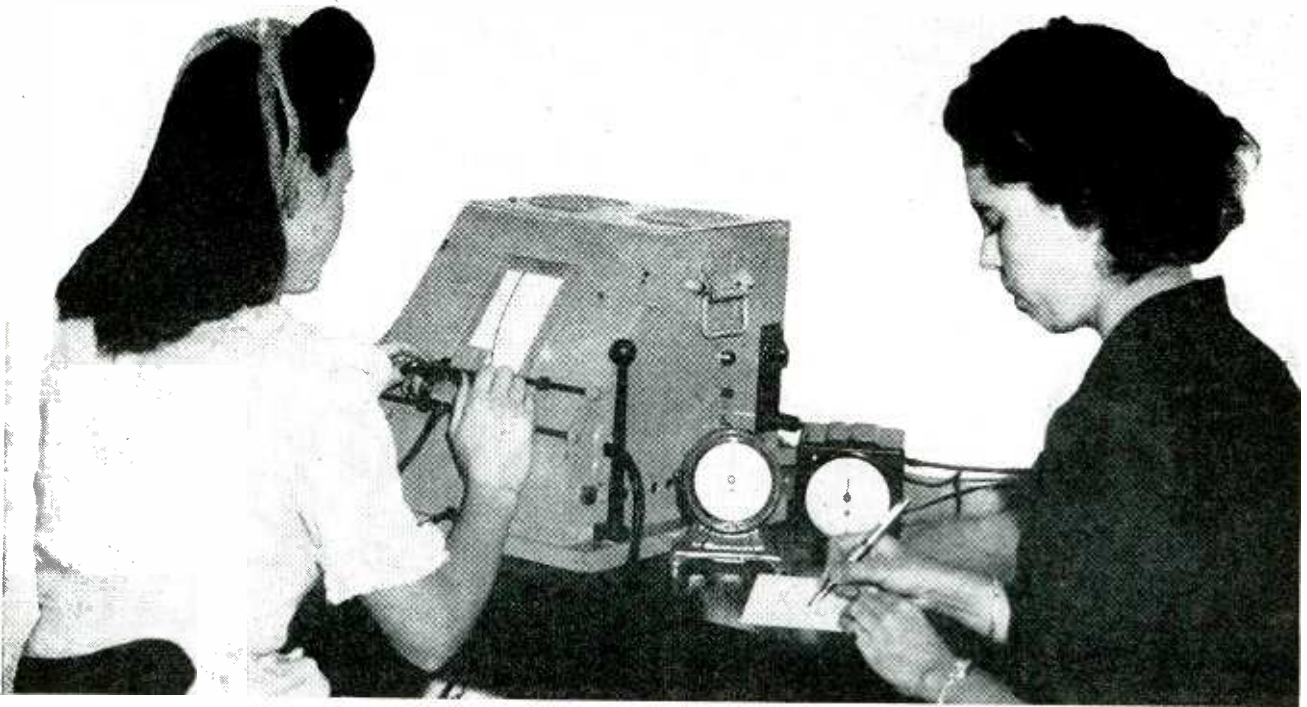

FIG. 8—Rousseau and angular diagrams of the directional pattern of Philco viewing screen



Operator at left moves phototube along horizontal rail with hands to keep it over moving line, while controlling motor speed with foot pedal so as to run paper from one drum onto the other as fast as possible. Total time taken for a test is clocked by observer

Aptitude Tester for Garment Workers

Operator attempts to keep phototube aimed at wavy black line while controlling speed of paper strip with foot pedal. Total time that phototube is off the line is correlated with time taken for test to find aptitude for operating sewing machine

By **E. G. HALLIDAY, F. ANDERSON, and E. O. GARNETT**

Principal Research Officer

Assistant Research Officer

Senior Scientific Assistant

National Physical Laboratory, Council for Scientific and Industrial Research, Union of South Africa

IN the science of aptitude testing, many devices have been evolved to measure ability of a subject to perform one or more operations involving a straight eye and steady hand. Every new research project involves the planning of one or more of these devices and adds to the stock of current psychological apparatus. The South African National Bureau for Personnel Research and the South African National Physical Laboratory recently co-operated in planning a set of ap-

ptitude tests, for one of which it was necessary to test the ability of a garment worker in handling a sewing machine. It was decided to use electronic methods, and the machine which was evolved is described.

General Description

In this hand-foot co-ordination machine, a wavy line is moved towards the subject at a speed which can be controlled by the subject with a foot pedal. The subject endeavors to keep a pointer in contact

with this line, and a clock automatically records all those intervals of time when the pointer fails to make contact with the line. When the line is comparatively straight the subject can speed up its movement but when there are sharp changes of direction the speed needs to be reduced. The time of the whole experiment, taken in conjunction with the total time during which the pointer was off the line, indicates the aptitude of the subject for machine sewing.

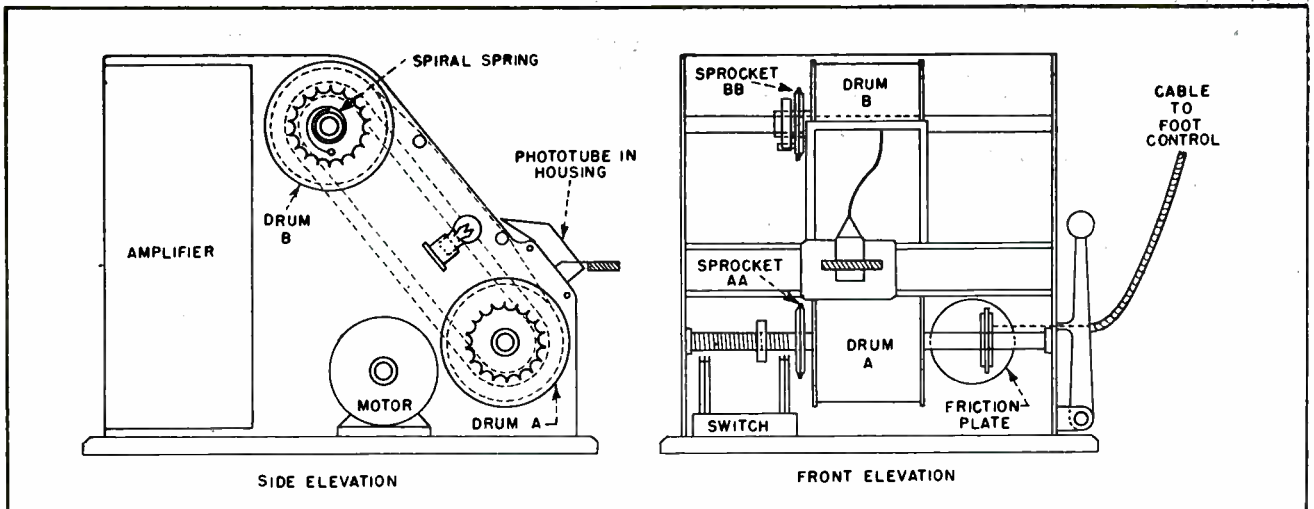

FIG. 1—Mechanical arrangement of photoelectric aptitude tester for sewing machine operators

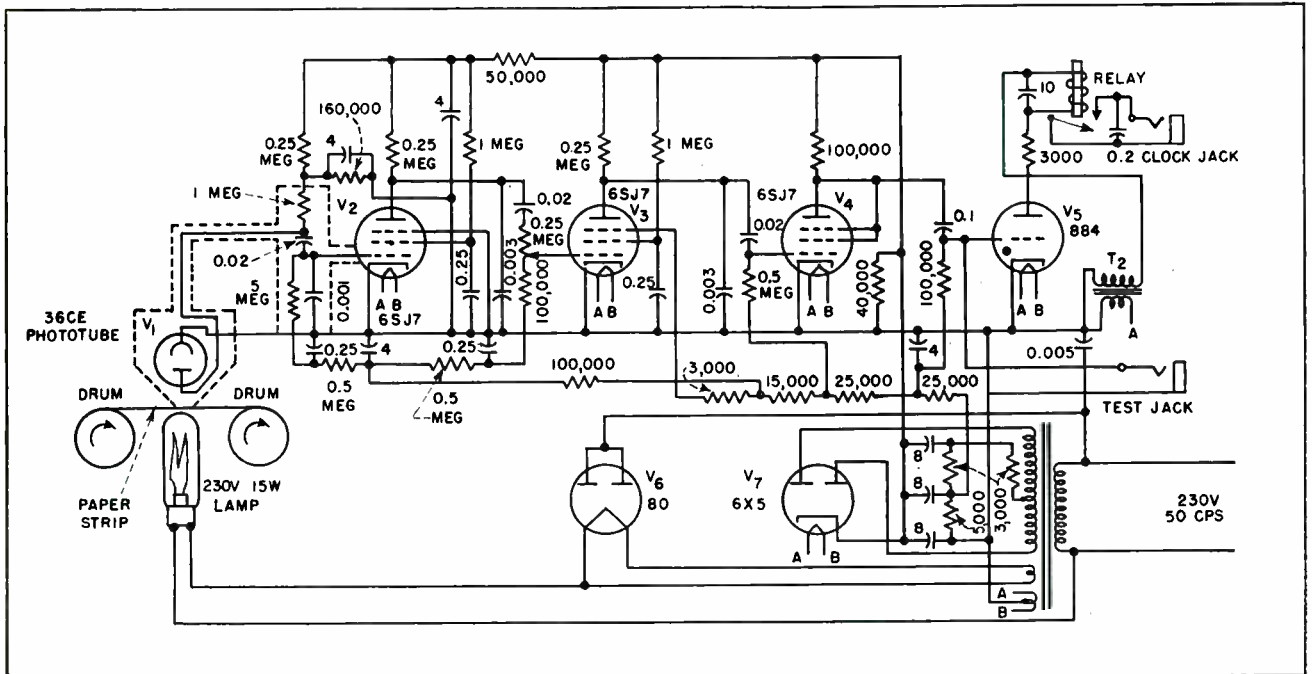

FIG. 2—Circuit of photoelectric amplifier used to start electric stop clock when phototube goes off moving line, and stop clock when phototube is on the line

The wavy line, approximately 15 feet long, is drawn in India ink on a strip of paper which can be rolled from one roller to another. The pointer is in the form of a hollow cone with a hole at its apex and encloses a phototube. A lamp placed behind the paper strip shines through this hole except when the hole is just over the India ink line. The response of the phototube to the light operates a relay through an amplifying system, switching on the electric stop clock to record

the amount of time the pointer was off the line.

Mechanical Details

Details of the mounting and drive for the two paper drums are shown in Fig. 1. The main frame consists of two end plates with a flat top and a 60-degree front panel all mounted on a wood baseboard. Between the end plates two half-inch steel shafts are mounted, each carrying a brass drum 3½ inches in diameter and 3½ inches long with ¼-inch flanges.

Drum A is keyed to its shaft, which is driven by a motor, while drum B rotates freely on the upper shaft.

Each shaft carries a sprocket on the left-hand side of the drum, the sprockets being joined by a chain drive. Whereas sprocket AA is firmly attached to the left-hand end of drum A, sprocket BB is freely mounted on a bushing projecting from drum B. A spiral spring is anchored to an extension of the bushing beyond the sprocket, and after taking several turns round the

bushing is fastened to a pin projecting from the sprocket. This spring keeps the paper strip tightly and uniformly stretched between the two drums and compensates for slight variations in diameter as the paper is wound off one drum and onto the other.

As the two drums rotate together through the chain drive, more paper comes off the full upper drum than goes onto the empty lower drum. The spiral spring is able to unwind, thus taking up the slack in the paper and keeping it stretched. When more than half the paper has been transferred to the lower drum the reverse happens and the spiral spring is wound up again.

The motor shaft is at right angles to the driven shaft and carries a large smooth-faced friction plate. The driven shaft carries a small rubber-rimmed wheel which can slide on the shaft on a keyway. A spring forces the friction plate against the small wheel, which can be moved up and down its shaft by a Bowden cable leading to a foot pedal on the floor. Thus continuously variable speeds are possible from zero, when the small wheel contacts the center of the friction plate, to a maximum when it is pulled out to the edge of the plate. The motor is a synchronous type so as to give accurately reproducible speeds for given positions of the foot pedal.

The phototube is mounted in a small metal box provided with a conical extension in front, which projects down until it almost touches the paper, and has a fine hole bored in it through which the light from the lamp behind the paper can reach the tube. The box slides on a pair of horizontal guide rods, and is provided with a suitable handle so that the subject under test may follow the movements of the ink line from side to side.

The output of the phototube passes to an amplifier located at the back of the apparatus. An electric stop clock cable is arranged to plug into this amplifier with a telephone jack. The sloping front panel has a window 5 inches long and 3 inches wide through which the paper can be seen. Behind the paper at this point is a metal gate with a well-fitted glass window to keep the

paper in a uniform plane close to the nose of the phototube box.

Limit switches prevent the subject from keeping the drums turning at the end of a test and winding the paper completely off the upper drum. The lowest shaft is threaded and carries a nut with a pin projecting from it and able to slide in a horizontal slit milled in a brass plate which is held parallel to the shaft. As the shaft rotates in the nut, the pin moves along the shaft, eventually striking one of the pair of limit switches. This switch reverses the motor and winds the paper back onto the upper drum. When the starting point on the paper is reached the nut and pin strike the second limit switch, which opens the main circuit and stops the motor, leaving the machine ready for the next test.

In order to shorten the time taken for the run back, a lever is provided at the right hand side of the machine. This can be operated by the tester, pulling the gear change cable much farther than is possible with the foot pedal and so increasing the paper speed by 50 percent.

Electrical Circuits

It was decided that a line $\frac{3}{8}$ inch to $\frac{1}{2}$ inch wide would be representative of the markings used on tailoring material in practice, and that a movement of about $\frac{1}{8}$ inch off the line should be sufficient to set the stop clock going. Therefore, a hole not larger than $\frac{1}{8}$ inch diameter was the largest that could be used to admit light to the phototube. This called for several stages of amplification before the signal obtained from the phototube could actuate a relay. Furthermore, as a d-c amplifier is necessarily an elaborate piece of equipment, the output from the phototube should preferably be a-c which can be amplified by a conventional amplifier.

For illuminating the paper strip an ordinary 230-volt, 15-watt lamp was placed at the back of the paper and supplied from the 50-cycle mains via a half-wave rectifier. In this way the lamp received current on alternate half cycles only and the cooling time constant of the filament was sufficiently short to allow

an appreciable fluctuation of the light output. The alternating component of the light flux was about 50 percent of the total flux. In this way the output from the phototube contained an appreciable amount of 50-cycle a-c.

The amplifier consists of two stages of pentode amplification in cascade, followed by one stage of triode amplification. This latter stage also serves the purpose of isolating the high-gain stages from the following stage which is a thyatron (gas-filled relay) having a mechanical relay in its anode circuit, this final relay operating the clock.

Resistance-capacitance coupling is used throughout the amplifier. The frequency response is made to have a rising characteristic at 50 cycles and to cut off the unwanted higher frequencies resulting from tube noises. The thyatron plate is supplied with a-c in such a phase with respect to the signal on its grid that it fires for part of the positive cycle. Thus the current flowing in the plate circuit is pulsating d-c, which is used after filtering to actuate the mechanical relay.

A gain control is incorporated in the second pentode stage so that the sensitivity of the apparatus can be controlled to a certain extent. Fixed bias is used on all the tubes to forestall any difficulties which arise occasionally from phase shifts when cathode biasing is used. For the same reason the bypass and blocking capacitors are large enough to cause negligible phase shift at 50 cycles.

For ease of servicing, type 6SJ7 tubes were used for all three amplifier stages. The somewhat unconventional way in which the a-c voltage for the thyatron plate is obtained was necessitated by the fact that no power transformer could be obtained having a second insulated high-voltage winding.

Validation tests on this machine are at present being made by the Bureau for Personnel Research. Apart from small alterations and adjustments it is proving satisfactory in operation, and a first estimate of its ability to indicate aptitude for certain types of garment work is promising.

Reversible-Motor Controller

UPPER AND LOWER LIMITS of a sector-scanning radio receiver are set by the circuit shown in the accompanying drawing. It can also be used with any device that oscillates between occasionally changed limits. Devices to which it might be adapted are radio transmitters, radar equipment, automatic factory techniques using milling machines, lathes, or variable-depth boring tools; in short, any device that must move repeatedly between two points within its complete range.

Circuit Operation

The circuit is relatively simple. Either end of the automatic scan can be set without regard to the other by means of linear potentiometers R_1 and R_2 at a remote point. Potentiometer R_3 is geared to the turning mechanism of the remotely controlled load so that its full resistance is traversed with the complete range.

Relay 1 controls direction of travel of the motor. The load will be raised when Relay 1 is de-energized, lowered when it is energized. With the potentiometers in the positions shown, Relay 1 will be initially de-energized and the motor will raise the load until the voltage at C of R_3 very nearly equals the voltage at A of R_1 . Relay 1 will then be actuated by the firing of Tube 1 and the motor will reverse, lowering the load. Tube 1 will remain conducting until the voltage at C of R_3 nearly equals the voltage at B of R_2 . At this condition Tube 2 will fire and Relay 2 will be actuated momentarily, thus de-energizing Relay 1. This action will deionize Tube 1 and reset the circuit to the original condition.

Upper and lower limits must not be crossed. Some mechanical means should be provided to pre-

Circuit sets limits of rotation of a continuously reversing motor for such applications as repeatedly tuning through a radio band or controlling reciprocators in factories

By J. GREGG STEPHENSON

Engineer
Airborne Instruments Laboratory, Inc.
Mineola, N. Y.

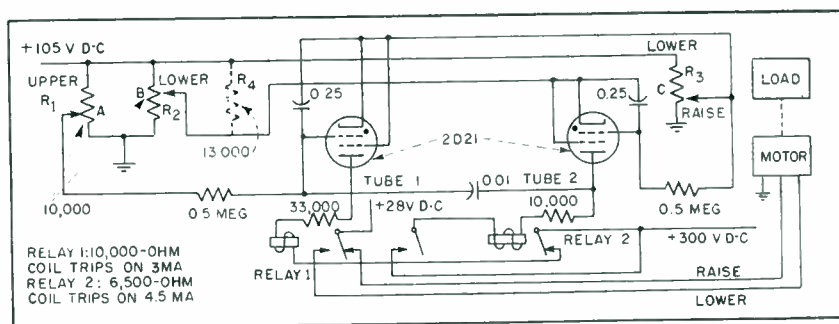

Circuit automatically reverses motor when load reaches preset limit

vent this possibility. On the other hand, if by some means, the load is moved past the lower limit, the load will be raised into the desired sector when the circuit is energized. If the load is moved past the upper limit, it will be lowered into the sector when the circuit takes control.

Design Considerations

Potentiometers R_1 , R_2 and R_3 should preferably be supplied from the same d-c voltage, but, if necessary, separate regulated supplies having the same output voltage can be used, thus saving one control wire.

Potentiometers R_1 and R_2 can be arranged to indicate sector limits on the same linear scale, but some error in the lower limit indication will result from a small current passing through R_3 when Tube 1 and Relay 1 are energized. This error can be minimized by (A) a low

resistance potentiometer at R_3 , (B) a sensitive coil for Relay 1, (C) a higher d-c voltage on all potentiometers, or (D) a compensating resistance (R_c). If separately calibrated indicator scales are used for R_1 and R_2 , this error is eliminated.

Values shown on the diagram were chosen for remotely tuning a radio receiver. Both upper and lower limit potentiometers indicate on the same linear scale and are arranged mechanically so that electrical crossover is impossible. Using inexpensive three-watt, wire-wound potentiometers and R_c , maximum error in indication of sector limits is about 3 percent of the total tuning range. The circuit is stable down to a minimum sector of about 0.25 percent at a sweep period of 30 seconds over the entire range. Tripping is consistent within about ± 0.05 percent for a given set of tubes.

By **WILLIAM M. JUREK**
and
JOHN H. GUENTHER
The Langevin Company
New York, N. Y.

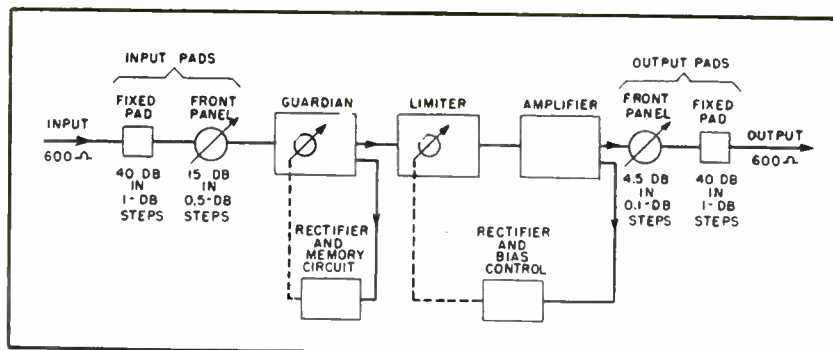

FIG. 1—Functions of the various stages in the amplifier

Automatic Gain Control and Limiting Amplifier

An agc amplifier regulates the audio signal applied to a peak limiter so that the output is held constant to provide a high percentage of modulation in a transmitter or high level for recording or public address. A memory circuit holds the gain constant for a predetermined time to preserve dynamic range of program

The automatic gain control and limiting amplifier (Progar) to be described was designed to bridge the gap between the physical limitations of broadcasting, recording, and public address equipment and the ability of operating personnel to maintain an efficient program level within these limits.

In broadcasting, dynamic limits are sometimes exceeded because of an operator's desire to maintain a high percentage of modulation at all times. Early attempts to alleviate this situation made use of peak limiting or compressor amplifiers at the transmitter. Unfortunately, this led to relaxing of critical monitoring. Operators relied upon the peak limiter to maintain a high average percentage of modulation, disregarding the fact that this statement holds true only when the proper signal level is fed into the peak limiter.

Guardian Amplifier

The Langevin 119-A unit was designed to be inserted between studio audio facilities and the transmitter. (Several have also been

built by Royal S. Howard of the Associated Broadcasting Company in San Francisco.) Figure 1 shows the sections into which it is divided, consisting essentially of an automatic gain control or guardian amplifier that provides a regulated audio flow and an improved type of peak limiter amplifier.

The input signal is first fed into the guardian amplifier and from there branches into two circuits, part going to the peak limiter and part going into the rectifying and memory circuit. The output of the rectifying and memory circuit controls the gain of the guardian amplifier. The output of the limiter also branches into two circuits, part going to the output load and part to the rectifier and bias control circuit which provides fast gain reduction action of the peak limiter amplifier.

Figure 2 shows the combined action of the guardian and limiter circuit. The lower graph represents the guardian action. The vertical axis represents the peak value of the input signal, and the horizontal axis represents the peak

value of the signal at the output of the guardian circuit, which is also the input to the peak limiter. The vertical axis of the upper graph represents the peak value of the output signal.

Gain Control Action

The input controls are adjusted so that the average peak input signal is -31 db. The average peak into the limiter occurs at point A, which is at the knee of the curve, and the average peak output is $+22$ db, which is made equivalent to 80 percent modulation. As the body of the program material falls below the average peak, the full dynamic range of the material is reproduced due to the linear action of both amplifiers. Any transient peaks above the average peaks are compressed in the limiter section.

If the average peak value of the input should increase and remain there for any reason, as from -31 db to -21 db, the input to the limiter will increase to B and the average peak output will be $+23$ db, or 90 percent modulation. Under this condition, part of the body of the

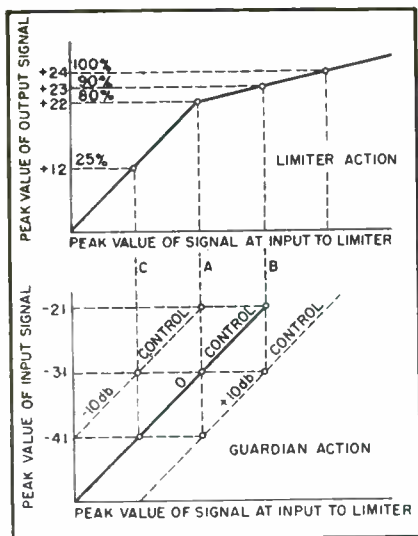

FIG. 2—Circuit action of the combined amplifiers at various levels

program below the average peaks will be compressed in the limiter. The gain of the guardian amplifier is then reduced to the -10 db control line so that the increased input produces an output from the guardian back at A, and the output from the limiter is again back at +22. The time for the guardian section to decrease its gain is much slower than the limiter attack time but is still too fast to be detected by the ear.

If, while the limiter is in this condition, the operator changes the input level back to normal (to -31 db), the input to the limiter will drop to C and the output signal to +12 db. The guardian section does not act immediately, but the memory circuit holds the gain constant for a predetermined time and then allows the gain to increase gradually to normal as represented by the zero control line. This wait time is relatively long and in present models is adjustable from 2 to 8 seconds. This long delay is provided to allow for station breaks and fade-outs as used in dramatic shows. If the action were extremely fast, the amplifier would try to maintain constant output continually and destroy the dynamic range of the program.

Should the average peak input signal level drop below its normal value, as from -31 to -41 db, with



Authors Guenther and Jurek check a specification sheet for the Progar amplifier

the corresponding output of +12 db, the guardian amplifier gain will again be held constant by the memory circuit for the predetermined time and will then slowly increase to the +10 db control line, bringing the output of the guardian amplifier back to normal. Upon restoring the input signal to normal again, the input to the limiter will be at B, and the limiter will instantly reduce this increased input signal to a safe output value until the guardian gain changes again.

The combination of the two amplifiers maintains a steady audio flow into the transmitter at all times. As is seen from the lower graph in Fig. 2, the gain-changing action of the guardian amplifier is not strictly of the compressor type, due to the action of the memory circuit. Therefore, even though the average dynamic range is changed, as it will be in any gain-changing amplifier, the dynamic expression is not affected.

Circuit

Figure 3 shows a schematic of the complete unit. The audio section of the amplifier consists of four push-

pull cascade stages with transformer input and output. The first two tubes are the guardian control section; the second stage is the limiter amplifier control section; the third stage is the linear amplifier section; the fourth stage is the power output section.

The control circuit for the guardian section consists of a two-stage resistance-coupled pushpull linear amplifier operating into a full-wave rectifier. The output of the rectifier feeds an RC circuit which builds up the d-c potential in proportion to the incoming program level. A portion of this potential is fed through the conducting diode, V_{12B} , into capacitor C_{22} . The voltage across C_{22} is then fed into the guardian amplifier control tubes. With the correct input signal applied to the tubes (-31 db), the bias of the tubes is established by the control circuit, mentioned above, to set the gain of the tubes in the center of the operating range. The purpose of this condition is to allow the tubes to increase or decrease amplification by approximately 15 db, thereby effecting the agc action.

If the incoming signal should be

increased, additional potential is developed in the first RC circuit of the control section. Portions of this voltage are almost instantly transferred through conducting diode V_{12B} into C_{22} , increasing the control voltage on the tubes and thereby reducing the gain of the first stage and reducing the signal to the proper level going into the second stage. This circuit may be referred to as a reverse-acting control circuit whereby the operation of the circuit depends upon permissible error, which in this case is 1-db change in the output for a 10-db change in the input. Therefore, the action taken by the control circuit must be such that it produces enough control signal to reduce the incoming signal 9 db with only a 1-db increase in the output.

If the average peak of the input signal should drop from its normal value, the charging voltage will be reduced across C_{20} . If the signal is slightly reduced, no effective change will be produced on C_{22} because this capacitor may only be charged by V_{12B} , or discharged by V_{12A} and then

only if the voltage of C_{22} equals the voltage of C_{20} .

This circuit is the heart of the guardian circuit, and is referred to as the memory circuit. This explains the reason why during a symphony concert the pianissimo passages are not affected, as some portions of it keep the first RC (C_{20}) charged sufficiently so as to prevent C_{22} from being discharged, thereby keeping the gain constant in the guardian circuit. Should the program drop completely, capacitor C_{20} would start discharging because no signal is being fed into the control circuit. As soon as the voltage across C_{20} equals the voltage across C_{22} , the conducting diode (V_{12A}) would start discharging C_{22} at the same rate along with C_{20} . This would reduce the control voltage, allowing the gain to increase in the guardian stage. This gain will increase to the limit determined by the setting of the guardian increase limit control. The purpose of the guardian increase limit control is to limit the maximum gain of the control amplifier when no signal is present. In

average studio conditions, a 5-db limit is recommended. Ten and 15-db limits are provided for unattended service if the noise level of the preceding equipment will allow this additional gain.

A Guardian Action Disabling switch is provided for testing this circuit for normal gain conditions and for tube balance checks. This switch substitutes a fixed bias in place of the control circuit bias.

Guardian action is observed by measuring the combined plate currents of the guardian control tubes. This measurement is only relative as it measures the plate current of the tubes and is calibrated in terms of audio signal. A calibration control is provided to set the meter at zero position when the guardian action switch is in the disabled position.

The peak limiter section is composed of the last three pushpull stages, with a biased diode rectifier connected across the output. This rectifier rectifies a portion of the output voltage whenever that voltage exceeds the predetermined

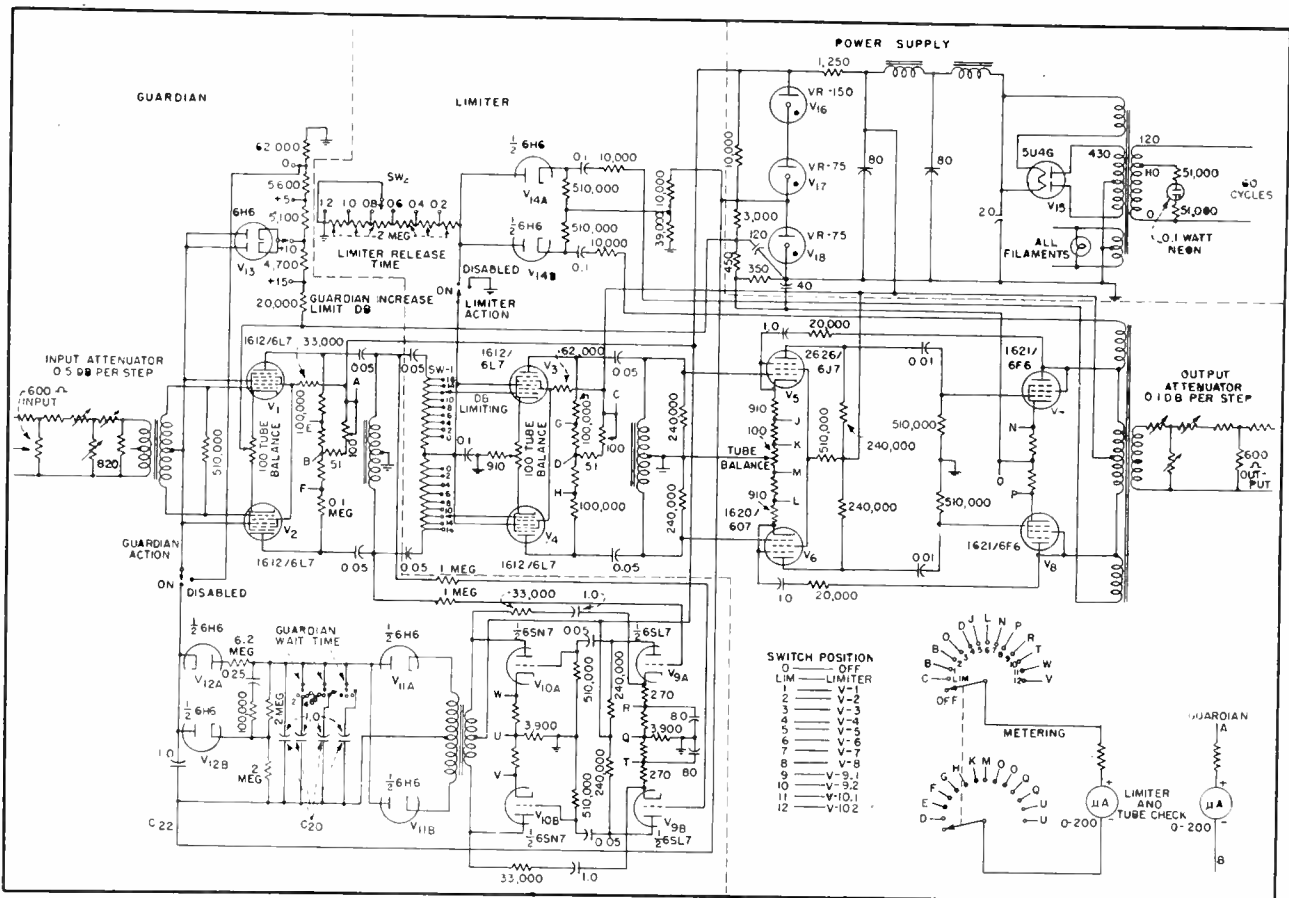
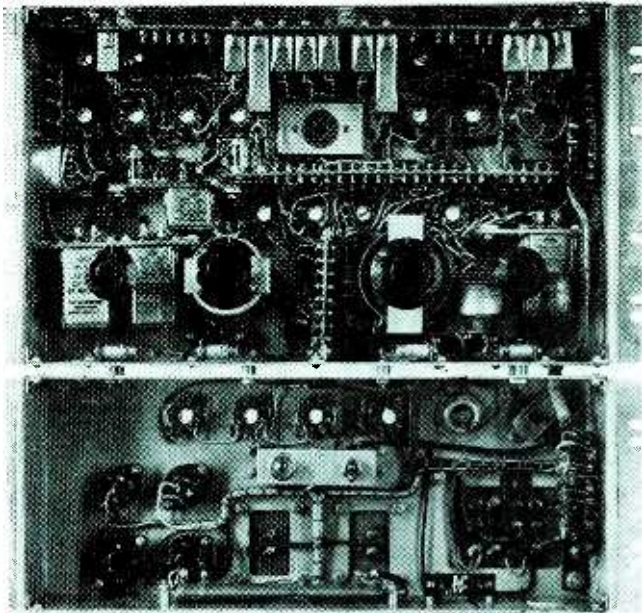
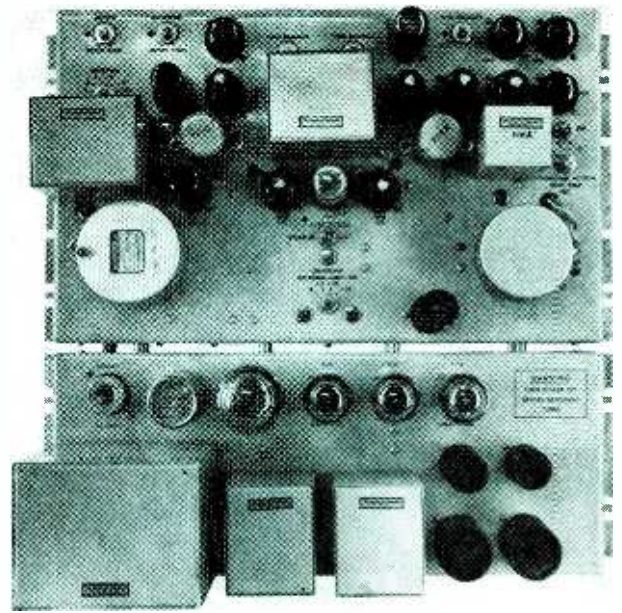

FIG. 3—The complete circuit is basically a four-stage audio amplifier, with added control circuits for the special functions



Front view of amplifier chassis with meter panel removed



Screwdriver-adjusted controls are accessible from the rear

amount and applies that rectified voltage as a bias to the limiter input stage.

The limiting action is also a reverse-acting control circuit, and is designed to operate at a 10:1 control ratio, whereas a 10-db increase in input signal produces only a 1-db increase in output signal above the predetermined peak value.

The output of the guardian section is so adjusted that when the limiting control is in the zero position no limiting action takes place on normal program material. Due to the slow attack time of the guardian circuit normal transients appearing in the signal have no effect on the guardian control circuit and are passed on to the limiting section where they are reduced by the control action of the limiter. This also explains why steep wave front tones such as certain piano tones and cymbal crashes have little or no effect on the guardian action, and if dangerous to the transmitter are reduced to a safe value by the limiting action.

Circuit Tracking

Reverse-action control circuits were selected for both of the control circuits in place of forward-acting control circuits because of the extended range of control without cutting off the amplifier. Forward-acting circuits give difficulty in maintaining the control action over a range greater than 13 db. After

that point, they have a tendency to cut off the controlled amplifier completely, thereby producing noticeable holes in the program material if the peaks should exceed the normal operating range encountered in practice.

The forward-acting control circuits receive their control voltage from the input of the amplifier and must develop the control voltage that will track along with the control action of the variable-gain tubes. The control circuit rectifiers produce a voltage that is linear to the input voltage, while the controlled tubes require a logarithmic voltage. Therefore, the tracking of a forward-acting circuit is difficult to control over an extended range.

In the reverse-acting control circuit, tracking is no problem as the circuit is selfbalancing, working on permissible error, and control action is automatically extended beyond the required 30 db.

Semifixed and variable attenuators are provided at the input and output to adjust the input signal and provide the unit with the proper input signal of -31 dbm (db referred to a zero level of 1 milliwatt), and to adjust the output of $+22$ dbm to correspond to 80 percent modulation at the transmitter. These input and output levels must be established before putting the unit into operation.

Semifixed pads with a 40-db range are provided at the input and

output to allow the unit to be substituted in place of the conventional line or program amplifier or inserted as a zero-gain device at the transmitter audio input.

Common Power Source

The power supply is conventional with VR regulator tubes stabilizing the critical voltages such as the guardian circuit and the limiter diode bias. It is recommended that the power supply be operated from the same a-c power source as the modulating stage of the transmitter. This is to allow for the variations in the line voltage that will change the modulation capabilities of the transmitter and will also change the output capabilities of the Progar, and will therefore maintain a uniform maximum operating point of both units simultaneously. If a well-regulated power supply is used, a constant fixed output will be maintained, and as the line variations affect the modulation capabilities of the transmitter the full benefits of the control action could not be utilized.

For network operation, it is advisable to use one unit at the studio with the limiter action disabled, and a second unit at the transmitter with the guardian action disabled. The reason for this recommendation is that if the two limiters are used in cascade with different release times, a pumping action will be noticeable on some program material.

Precision Balancing at



With this ultraprecision electronic balancing machine, a skilled operator can easily balance 200 gyro rotors a day to an accuracy of a few micro-ounce-inches. A drill press is conveniently located alongside the machine, and the operator alternately measures and drills until the required balance is achieved



Rear view of gyro balancer, showing how amplifiers are arranged on two separate chassis units that can readily be removed for servicing

THE heart of an automatic pilot for aircraft is the gyroscope or gyro rotor, which rotates at 10,000 to 20,000 rpm and must be dynamically balanced to a degree of accuracy hitherto unattainable. Production demands for these rotors in the Jack & Heintz plants rose to an unprecedented total of 35,000 units per month during the war, each balanced to the astonishing accuracy of a few millionths of an ounce-inch. This is the story, told now for the first time, of the ultraprecision electronic balancing instrument which did this work.

The Balancing Problem

The gyro rotor, shown in Fig. 1, is a round rigid body which is to rotate about a rotational axis determined by the positions of the pivots or conical bearing surfaces which form the inner races or cones of the

ball bearings. Another axis through the rotor, near the rotational axis but so directed as to pass through the average of the positions of the centers of gravity of successive thin sections taken along the axis, is called the axis of inertia. This is the axis which will produce no pressures on the bearings due to centrifugal forces when rotation takes place about it. Dynamic balancing involves shifting the axis of inertia until it coincides with the rotational axis within the balance accuracy required. (Strictly speaking, the axis of inertia is defined as the z axis about which the summation of the products of inertia is zero.)

The condition of unbalance can be located, measured, and expressed as a weight of w ounces located r inches from the rotational axis. The dimension ounce-inch was found to be inconveniently large

for gyro work, hence the micro-ounce-inch (one millionth of an ounce-inch) was used. The required sensitivity for the balancing instrument was between 2 and 5 micro-ounce-inches; actually it was possible in the final design to attain a maximum sensitivity of one micro-ounce-inch.

Principle of Balancing

It can be shown analytically that regardless of the number or distribution of unbalance masses within a rigid body, balance correction can be effected in any two arbitrarily chosen planes at right angles to the rotational axis. Conversely, it can be considered that all the unbalance occurs in the two previously chosen planes of correction.

During rotation, centrifugal action of the unbalance masses at the two correction planes will produce

Mass-Production Speed

Ultraprecision electronic balancer brings gyro rotor up to test speed of 12,000 rpm in a few seconds and indicates amount and location of unbalance directly, permitting skilled operator to balance a rotor in two minutes by alternately measuring and drilling

forces on the resilient rotor supports, resulting in voltages that identify both magnitude and angular position of required unbalance correction.

The principle by which the balancing instrument could focus attention on one plane of correction without interference from the other may be demonstrated by reference to Fig. 2. Consider that a localized unbalance mass exists in each of the correction planes and that these masses have any angular configuration with each other. Let the unbalance forces due to each of these masses be represented by W and X respectively. Force X will manifest itself at shaft ends A and B as components X_a and X_b respectively, all having the same angular orientation and of magnitudes such that

$$\begin{aligned} X_a + X_b &= X \\ aX_a &= bX_b \end{aligned} \quad (1)$$

Similar relations hold for components W_a and W_b . These four components of X and W will produce resultants R_a and R_b at ends A and B respectively.

Electrical transducers at ends A and B can produce voltages which are proportional both in magnitude

UNBALANCE CORRECTION SURFACES

PIVOT



FIG. 1—Gyro rotor. Air stream impinging on vanes in center drives rotor at 12,000 rpm during balancing tests

By SAMUEL BOUSKY

Physicist
Jack & Heintz Precision Industries, Inc.
Cleveland, Ohio

and in phase to the resultant forces R_a and R_b . Let us, for the sake of simplicity, allow the notations R , W , and X to indicate also the electrical voltage vectors corresponding to these forces. Then the voltages generated at A and B will also be represented by the vectors of Fig. 2. To the voltage R_a let us add a part of the voltage of R_b , reduced in magnitude by the factor b/a and reversed in instantaneous polarity as indicated in the lower right in Fig. 2. Resolving these into their original vector components, we see that $-(b/a)X_b$ is exactly equal and opposite to X_a since from Eq. 1

$$X_a = (b/a) X_b \quad (2)$$

Since the rotor is symmetrical with respect to dimensions a and b , $aW_b = bW_a$ and $W_b = (b/a)W_a$. Making the vector summation of voltages R_a and $-(b/a)R_b$, the X component disappears and the remainder becomes

$$W_a - \frac{b}{a} W_b = W_a \left(1 - \frac{b^2}{a^2}\right) \quad (3)$$

which is a voltage proportional both in magnitude and phase to the original force W only. By mixing the generated voltages in a proportion which is a function of the locations of the balance correction surfaces and the transducers alone, it is possible to determine both the location and magnitude of the unbalance on either correction surface.

Evolution of Final Design

For balancing, the rotor was initially mounted in the double suspension system of Fig. 3, using rubber as the resilient material and operated above resonance with moving-coil pickups as transducers. The pickup units are similar to the Western Electric D-93306 repro-

ducer for vertical transcriptions. Each pickup was coupled directly to the bearing suspension by means of a small piano-wire rod which drove the pickup sinusoidally while permitting rotary motion of the bearing. This rubber suspension method proved inadequate, however, because it permitted motion axially as well as radially, did not easily allow separate control of compliance and damping, and did not maintain the rotational axis location within sufficient accuracy between test and use.

The final suspension design overcame these limitations, while still maintaining the advantages of free plane motion, by employing ball bearings mounted in plates supported on three horizontal round cantilever rods. This permitted free motion in the planes of the bearings, but not axially. Damping was provided separately by enclosing each cantilever rod within a fluid-filled cylinder, the working end of which contained a thin neoprene dam for fluid retaining. Damping was controlled by means of beads mounted on each suspension rod and also by adjusting the properties of the fluid. Rosin dis-

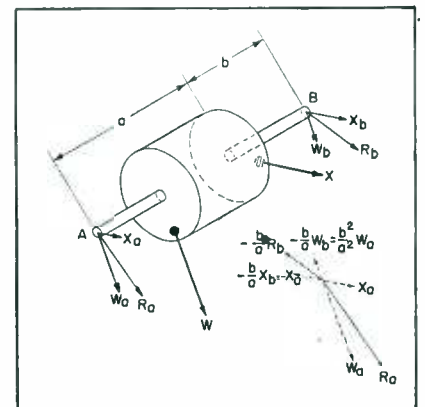

FIG. 2—Force reactions on rotor due to unbalance correction, and vector summation (lower right) for unbalance indication

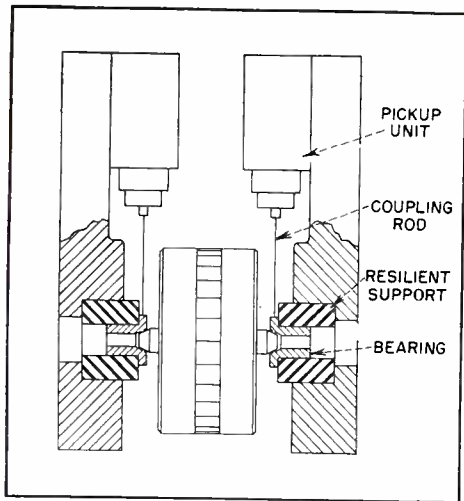

FIG. 3—Double suspension system used initially, having rubber bearing supports

solved in castor oil worked remarkably well in the early tests.

Phase response for both the mechanical and electrical parts of the instrument proved highly important. Low phase-shift band-pass filters were therefore used in the amplifier channels instead of resonant circuits. Low attenuation was required in the region of 200 cycles, high attenuation in the region of the mechanical resonance of the suspension, and high attenuation for all harmonics of the rotational frequency (400 cycles and above).

Since the phase shift in the filters is only one of several factors adding to error in location, 2 degrees total shift was arbitrarily set as permissible for the filters in the working speed range. Use of two filters in series to obtain the desired attenuation in the stop band cut this allowable phase shift in the working speed range down to 1 degree per filter.

A Strobotac was used initially for speed-measuring purposes, and gave accuracies easily better than 1 percent at 200 cycles, corresponding to a rotor test speed of 12,000 rpm. The use of a stroboscope for speed determination immediately suggested its use also for unbalance location by using the rotor as its own reference. If the corrected unbalance voltage were used to initiate the flash of the stroboscopic lamp, the spot requiring unbalance correction could (with proper phase adjustment) be illuminated. This spot could be easily identified stroboscopically while rotating if the

rotor were initially stamped with a series of numbers around its periphery.

The block diagram in Fig. 4 shows the final instrument design, including the mechanical suspensions, the connections for compressed air that supplies motive means for gyros under test, and the electronic circuits.

Final Mechanical System

Details of the final mechanical suspension appear in Fig. 5. The diaphragm-type construction of the bearing support disc is for the purpose of handling secondary axial and angular components of motion of the rotor bearings. These discs are machined of dural (17st) in one piece, with the diaphragm section reduced to a thickness of 0.0050 to 0.0055 inch. The pickup coupling rod is a 0.020-inch diameter wire. The suspension support rods are 0.040-inch diameter steel drill rod, the ends of which are threaded to permit alignment adjustment of the bearing support disc. The damping fluid was changed to one of the Dow Corning Silicones, which proved superior to the rosin-castor oil mixture.

The natural period of the entire suspension system with gyro rotor in place is very nearly 29 cycles, which is about a factor of seven below test speed. The damping produces a mechanical phase angle which changes less than 0.3 degree due to changes of damping factor under normal operation of the instrument and about 0.2 degree due

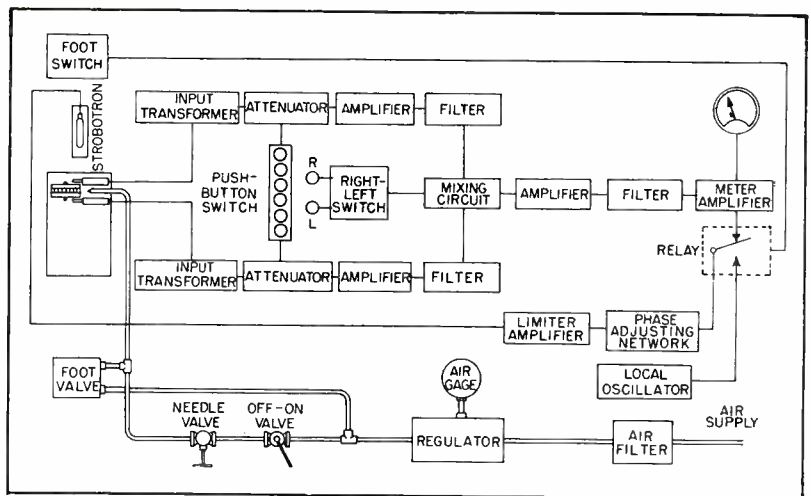

FIG. 4—Block diagram of ultimate balancer design. Air supply system drives rotor at required 12,000-rpm test speed

to changes of rotor speed within the normal operating speed range. The total mechanical phase shift error is therefore not over 0.5 degree. The mechanical displacement sensitivity is 0.2 micro-inch peak per micro-ounce-inch of unbalance and is unaffected by the normal speed range or by damping.

One suspension assembly is mounted on a ball-bearing slide to allow about an inch of motion for insertion and removal of test gyros. A calibrated spring acts against this slide to provide end thrust or bearing loading equal to that which obtains in actual assembly, thus reducing errors due to shift of rotational axis. A lock is provided for clamping the slide during test in such a way as not to disturb the accuracy of alignment. The ball-bearing slide reduces variations of end loading that might be caused by friction and at the same time provides for long-time accuracy of adjustment and ease of operation which are so important in production use. A vibration isolation mounting supports the assembly.

A cross-sectional view of one of the pickup units appears in Fig. 6. The impedance is about 6 ohms at 200 cycles, and sensitivity is about 45 db below 1 volt per inch per second velocity. In terms of balancing instrument requirements, each pickup will develop about 1 micro-volt rms open circuit for a peak sinusoidal displacement of 0.2 microinch at 200 cycles per second. Overall sensitivity at the 200-cycle operating speed is thus 1 microvolt

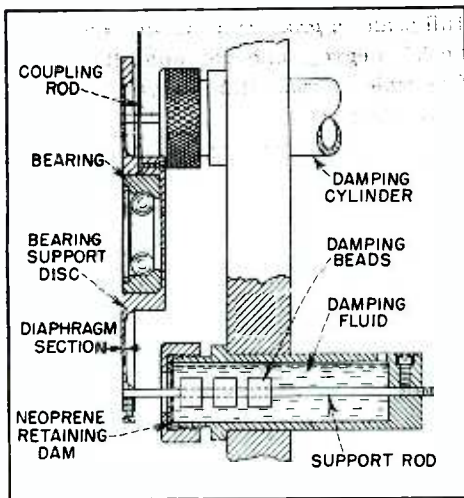

FIG. 5—Design of suspension assembly and damping cylinder

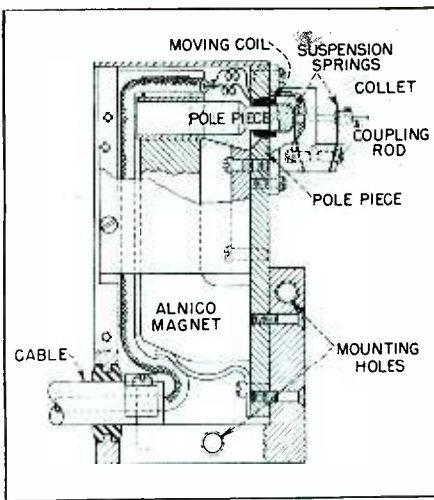

FIG. 6—Construction of pickup unit, showing similarity to p-m dynamic speaker

rms for 1 micro-ounce-inch unbalance.

The foot valve of the pneumatic system is operated only to attain rotor speed quickly, after which opening of the on-off air valve and proper preadjustment of the needle valve maintains rotor speed.

Final Electronic Circuit

In order that the signal mixing be accomplished at reasonable level, the pickup voltages are amplified separately in identical channels. Each channel employs an input transformer, an attenuator, a two-stage electronic amplifier, a special filter, and a gain adjustment, as shown in Fig. 7. The transformers are selected and matched for phase response, and each provides a step-up ratio of 1:150 or a gain of 43.5 db. The attenuators are pushbutton operated and ganged and each provides six steps of 10 db in a total resistance of 250,000 ohms. Each step corresponds to one scale range, the first or most sensitive being 0 to 30 micro-ounce-inches and the last being 10,000 micro-ounce-inches full scale. The attenuator pushbuttons are conveniently located at the front of the instrument table, each inscribed with a letter designating its range.

The amplifiers are identical feedback-stabilized two-stage sections of conventional design. Each provides about 40-db gain with negligible phase shift at 200 cycles. The filters are 100 to 200 cycle band-pass units of special design providing an attenuation of at least

25 db in the stop-band below 60 and above 400 cycles and a transition loss of less than one decibel in the working range of 180 to 220 cycles.

The design item of primary importance for the filter is the rate of change of phase angle with frequency in the working range. This is held within 0.5 degree per cycle and is constant for more than a ± 10 percent range of frequency at 200 cycles when used with the circuit terminations shown. The variable resistor in the output termination provides a ± 2 -db gain adjustment so that both channel signals may be matched overall.

Mixing Circuit

The mixing circuit provides a means of taking the output of one amplifier and adding to it a portion of the output of the other amplifier in reversed polarity as called for by Eq. 3. It also allows the operator to obtain an unbalance indication on either the left or right side of the rotor without interference from the unbalance of the other side. The circuit is switched by two pushbuttons located at the left of the instrument table.

Inverse feedback added to an amplifier produces many advantages but one disadvantage here is that with it the amplifier is no longer a passive network, and a voltage applied at its output end may be amplified to cause disturbing interference. The resistors in each input leg of the mixing circuit are isolating networks to avoid this

difficulty. This isolation is effected at the expense of gain, part of which is recovered in the mixing transformer while still allowing a net loss through the mixing circuit of about 28 db.

The focus adjustment potentiometer permits adjustment of the ratio b/a (Eq. 2 and 3) and when calibrated provides a loss of about 15 db for one channel with respect to the other. The phase-adjusting capacitor in the mixing circuit provides for a small phase adjustment of the vector $(b/a)R$, (Fig. 2).

Meter Amplifier

The amplifier and filter following the mixing circuit are identical with the input counterparts already described. The amplifier recovers the voltage lost in the mixing circuit. The additional filtering provides appreciable isolation of the fundamental unbalance signal with respect to extraneous bearing vibration components, permitting the operator to obtain an unbalance indication for an unbalance component appreciably weaker than the bearing vibration disturbance. The filter output termination here again provides ± 2 db gain adjustment for overall calibration of the signal which at this point has a value of about 1.0 volt rms at full-scale meter deflection.

The meter amplifier provides an additional gain of 17 db to its output, together with signal rectification for the meter movement. One diode of the rectifier provides half-wave rectification for the meter, while the other bucks out the normal zero-voltage diode current.

The meter has a 4,000-ohm 100-microampere d-c movement and is arranged with two scales laid out to be 10 db apart. Above these scales are 12 arbitrary balance numbers laid out 1 db apart for the operator's convenience in remembering or denoting the magnitude of unbalance. These are used with any of the six scale ranges by prefixing the letter designating the scale range. For instance, an unbalance of 200 micro-ounce-inches can be more readily designated by the operator as a reading of C9. These numbers are spaced well within the accuracy needed by the operator in effecting a balance and greatly en-

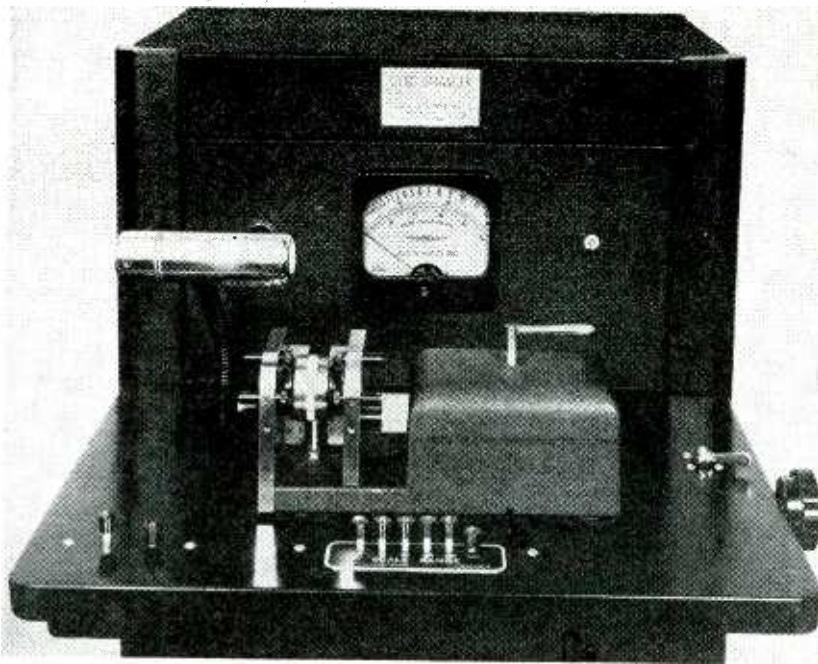

Instrument table and front panel of gyro balancer. Speed-checking strobtron is in lamp housing above gyro rotor. Pushbuttons L and R at lower left determine which end of rotor is checked, and buttons at center control range of meter

full-scale signal this value would be 0.3 degree, and for one-fifth of full-scale signal this value would be 2.9 degrees.

A voltage-regulated power supply to the limiter maintains the limiter output constant in amplitude. Thus we have an output wave constant in amplitude and with less than 3 degrees error in phase angle over a factor of 10 variation of input signal amplitude. If the instrument is calibrated for phase angle at one-third of full-scale meter reading, the angular error in determining unbalance location from this cause is within $\pm 1\frac{1}{2}$ degrees from one-fifth of full scale to twice full-scale indication.

Strobtron and Oscillator

To trigger the strobtron tube, a single sharp pulse is most desirable. This is easily obtained by differentiating the square wave. The $0.0005\text{-}\mu\text{f}$ capacitor and 1-megohm resistor combination comprise the approximate differentiating network. However, to avoid the formation of both sharp positive and sharp negative pulses which may produce double-frequency firing of the strobtron, the $0.005\text{-}\mu\text{f}$ capacitor is used in the plate circuit of the limiter to round off one side of the square wave.

A relay operated by a foot switch may be used to change control of the firing of the strobtron from the unbalance signal to a fixed-frequency signal from a local oscil-

hance the production use of the instrument.

The phase-adjusting network following the meter circuit makes the necessary calibrating provision for synchronizing the instant of strobtron flash with the location of unbalance on the rotating gyro wheel. This network provides a 50-degree adjustment of electrical phase angle but in so doing adds a transmission loss of 17 db. The loss through the network, however, is constant within ± 1 db as the phase angle is changed through the total 50-degree range.

Final Amplifier and Limiter

The signal at this point is again about one volt rms for full-scale meter reading, and is essentially a sinusoidal voltage which may vary by more than a factor of 10 over the useful range of unbalance position indication, which is from about 1/5 of full scale to about a factor of 2 beyond full-scale meter reading. Accordingly, some means must be provided for flashing the strobtron consistently with a high degree of phase-angle accuracy in spite of this large variation of signal amplitude. This function is accomplished by the final amplifier and limiter-differentiator.

The final amplifier and its output transformer serve only to supply

a very large signal to the limiter stage; together they produce a voltage gain of about 42 db. Thus for one-volt input, about 125 volts appears at the limiter grid. The limiter is of more or less conventional design and is arranged to utilize only about 1.25 volt of the signal at its grid. The output wave form will, therefore, be a flat-topped wave on which the electrical angular distance represented by the vertical portion of the wave may be considered to be approximately $\sin^{-1} 1.25/1.25$ or 0.6 degree. For twice

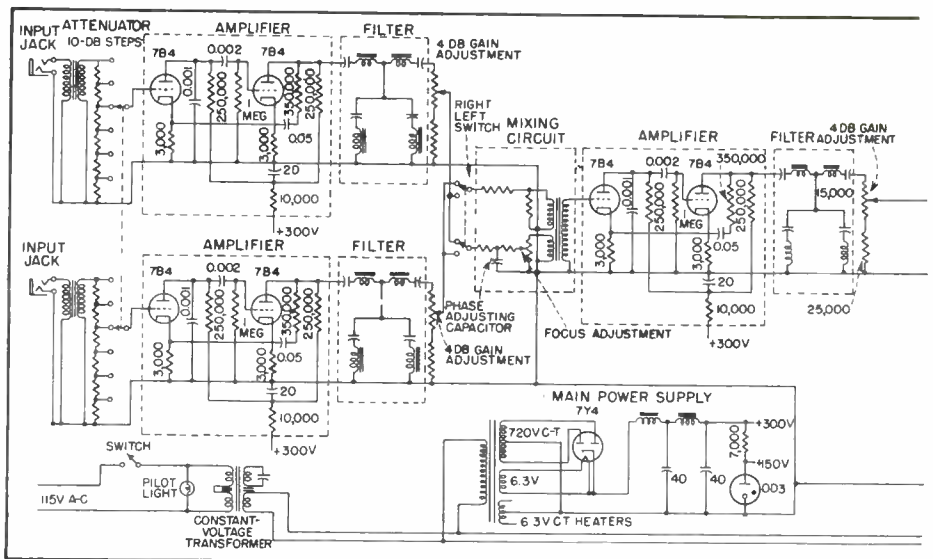

FIG. 7—Complete circuit diagram of gyro balancer. Constant-voltage transformer

lator, permitting use of the strob-
otron for determining rotor speed.

The 200-cycle oscillator has a more or less conventional two-stage RC feedback circuit except that stability is obtained by means of inverse feedback across the amplifier portion. The stability thus obtained is surprisingly good. The frequency drift, greatest during the first hour of use, is not over 1 percent during this period. Oscillators calibrated an hour after being turned on remain within 2 percent of calibration when similarly checked over a period of months. The variable resistor in the feedback circuit provides a frequency adjustment of about ± 7 percent to take care of frequency calibration.

A separate power supply was used for the strobtron to avoid the danger of having firing pulses get back into the amplifiers through the main power supply.

The complete circuit was built up from a number of two-tube sub-chassis units to facilitate rapid replacement of circuits in the event of trouble in production use and to permit better control of circuit element quality in the manufacture of the instruments. In manufacture these amplifier components were built up complete, then individually checked and adjusted for gain, frequency response, and phase shift. Each subchassis is easily removed for replacement by unsoldering the few leads and removing two screws. Replacement of a pretested ampli-

fier section can thus be made in a few minutes.

After construction of an instrument is completed, some simple means of primary calibration are essential before it can be usefully employed. The four items requiring calibration are: (1) test speed or oscillator frequency; (2) unbalance magnitude or overall gain; (3) unbalance position indication or overall phase; (4) focus or mixing circuit balance.

Calibration Procedure

The primary standard for checking oscillator frequency is the 60-cycle power line frequency. A disc having ten equally spaced holes is mounted on the shaft of a small 3,600-rpm synchronous motor which while running is illuminated with the strobtron excited from the oscillator. A stationary pattern is obtained at 200 cycles by catching each third hole during rotation. The next nearest stationary patterns with this method occur at 150 and 250 cycles; since these are definitely beyond the range of the oscillator, this system provides a positive primary calibration.

To calibrate for unbalance magnitude, a standard rotor was prepared with two small holes drilled on each face, precisely 0.700 inch from the center of rotation. These holes were tapped for a 0-80 screw, and the rotor was then carefully balanced. Next a 0-80 screw was prepared which weighed precisely

0.00143 ounce, and inserted into one of the holes provided for it in the standard rotor. Thus a known unbalance weight was added to the rotor at a known distance from the center, providing a standard unbalance of $0.700 \times 0.00143 = 0.001$ ounce-inch = 1,000 micro-ounce-inches. Since the 0.700-inch location can be easily determined and maintained to an accuracy of a few tenths of a percent and since the 0.00143-ounce weight can likewise be determined to a high degree of accuracy, this primary standard is dependable to 0.5 percent.

The procedure of calibration thus becomes simple. When the rotor is at test speed with the weight on one side of the rotor, the gain for that channel is adjusted until the meter reads 1,000 micro-ounce-inches or full-scale reading on the D scale. The weight is then transferred to the other side of the rotor and the procedure repeated for the other channel.

With the standard rotor and screw, the calibration of unbalance position indication also becomes simple. With the screw in position and the rotor at exact test speed, the strobtron must illuminate the rotor at the instant the position of the screw is aligned with a reference index line in the operator's field of view. The adjustment in the phase network provides means for a compensating adjustment.

The adjustment for focus is a little more involved and is also performed with the standard rotor and screw as reference. When all the above calibrations have been properly made, and with the standard unbalance on the right side, the standard rotor is operated at test speed. Under these conditions the unbalance reading for the left side should be adjusted for a minimum value. While a null value 20 db below the unbalance reading gave sufficient separation for good production speed, 30-db separation was usually maintained on instruments in production use.

Operational Procedure

With the instruments so designed and constructed and with calibrations properly made, results under actual production-shop operation proved most gratifying. The indi-

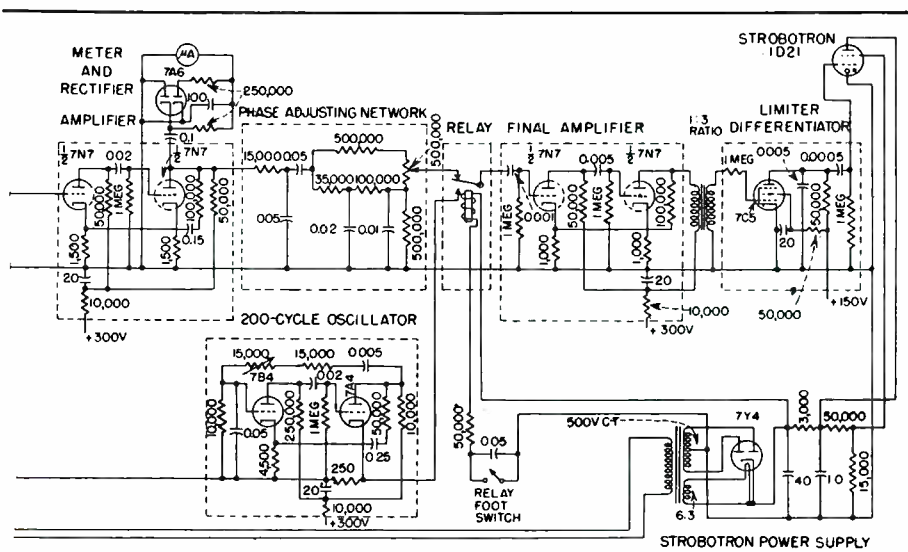

was used to offset the severe line voltage fluctuations encountered in industrial plants

ication of unbalance, both as to magnitude and position for both sides of the rotor, can be obtained by an average operator in five to ten seconds, and actually occupies a very minor part of the total balance procedure. A new rotor is inserted in the instrument by the operator, brought up to speed, and checked for unbalance. This data can be recorded on a pad, but is usually remembered by a good operator. The rotor is then removed from the instrument, inserted in a fixture on an adjacent drill press, drilled, cleaned using an air duster, and reinserted in the instrument. This complete process is repeated as many times as necessary (usually three or four) until the desired degree of balance accuracy is attained. This entire procedure is accomplished in two minutes time on the average, including the several drillings and instrument indications.

Initially the drill press was provided with two independent settings, one of which could be set to the scale or range letter and the other to the balance number on the meter dial. This predetermined the depth to which the drill would cut, so that with a standard drill size and point shape, the operator could remove the proper amount of material. It was found, however, that if the operator was allowed to exercise her own skill, she could perform this operation much faster and with no more error. In addition, the psychology of the uncertainty involved greatly aided in increasing her interest in the job and enhanced development of skill in rapidly making a judgment of the amount of material to be removed.

In training new operators, each was provided with a small gage on which were drilled five impressions corresponding to proper amounts of material to be removed for unbalance readings of B7, C7, D7, E7, and F7. By visual reference to this standard, the operator could judge the amount to be drilled out, and in about a week's time would develop skill to the point where she no longer needed the gage.

Accuracy Attained

The speed with which rotor balance can be attained depends pri-

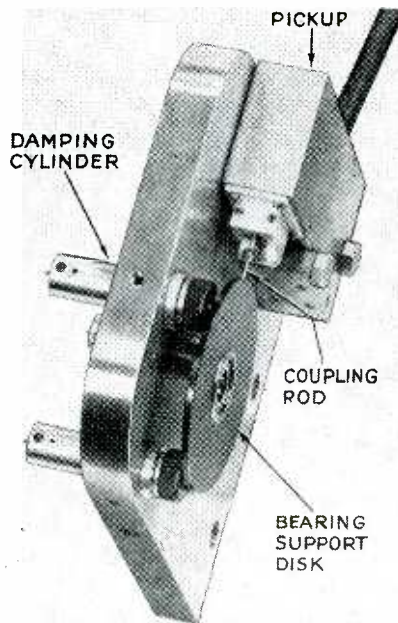

Suspension and pickup assembly used in final design of balancer

marily on the accuracy of angular location at which correction is made, and this in turn depends on several factors:

(1) The practical accuracy with which the rotor speed can be matched stroboscopically on production work. This we found to be easily effected within 0.5 percent.

(2) The accuracy with which this speed is maintained while taking an unbalance position reading. This was a function of operator experience and skill; it might have been 3 or 4 percent for beginners, but for experienced operators this was also within 0.5 percent.

(3) The frequency stability of the local oscillator. This remained within 2 percent over long time intervals, and by calibration was maintained within 1 percent.

(4) The overall instrument phase-angle error versus test frequency. This includes the sum effect of mechanical and electrical phase-shift errors and phase-angle stability. In this design the sum total error was maintained within ± 2 degrees phase shift per percent frequency deviation.

(5) The phase-angle error versus unbalance magnitude. On this design, the practical maximum error from this source was within 3 degrees phase shift over the useful range when making calibration at full-scale meter reading.

The sum effect of items 1, 2 and 3 results in a maximum error from these sources of perhaps 2 percent or 4 cycles. The effect of this on item 4 results in an uncertainty of unbalance position indication of ± 4 degrees. Adding to this the error of item 5 gives a maximum uncertainty of 7 degrees, although statistically it would be unusual for all errors to add simultaneously in this fashion. Practically, maximum uncertainty was well within the ± 6 degree criterion originally set for the total of all such errors.

The balance accuracy which can be attained on a rotor is not limited by the above errors nor does it depend on the operator's skill. These affect only the speed with which the balancing is performed. The unbalance on any production rotor could be reduced to 10 micro-ounce-inches; with selected rotor pivots and bearings this could be reduced to 3 or 4 micro-ounce-inches. Some rotors, with exceptionally accurate rotor pivots, were actually balanced to 1 or 2 micro-ounce-inches. Tests on such rotors indicated that the balancing instrument could maintain a sensitivity of 1 micro-ounce-inch, better than a rotor's physical stability for this magnitude.

The maximum useful range of the balancer is from 1 to 20,000 micro-ounce-inches. An experienced operator can easily effect a balance on a rotor with an initial 20,000 unbalance down to the production limit of 20 micro-ounce-inches or less in the order of two minutes. The best operators could easily maintain this speed and could average 200 rotors per day per machine while actually operating the machine only 45 minutes each hour to avoid fatigue. The operator holding the record for the greatest number of gyros balanced in one day turned out over 350 rotors.

This amazing speed on so precise an operation is of course partly due to the design of the instrument and the conveniences for the operator included for its use. However, a major portion of the success was due to the excellence of departmental supervision and to the industry, zeal, and enthusiasm with which an unusually outstanding group of girls tackled a tough wartime assignment.

R-F Inductance Meter

Two r-f oscillators, one with unknown L in series and the other with standard C in parallel, are tuned to zero beat. Value of unknown inductance at selected test frequency is then read directly on scale of capacitor with accuracy within 1 percent for 1 μ h to 100 mh

By

HAROLD A. WHEELER

*Wheeler Laboratories, Inc.
Great Neck, New York*

THIS direct-reading r-f inductance meter is designed for quickly and accurately measuring inductance of a radio coil. Errors in readings are within about one percent of the observed value for the rated range of inductance, which is unusually close when applied to one-tenth of full scale. This tolerance of error is based on the usual types of radio coils with fairly small inherent capacitance and at least a moderately high ratio of reactance to resistance.

The measurement of small capacitance is a valuable byproduct use of the instrument. It is direct-reading in terms of the difference of two scale readings, and its errors are only those of the precision capacitor included in the inductance meter. This measurement is made at radio

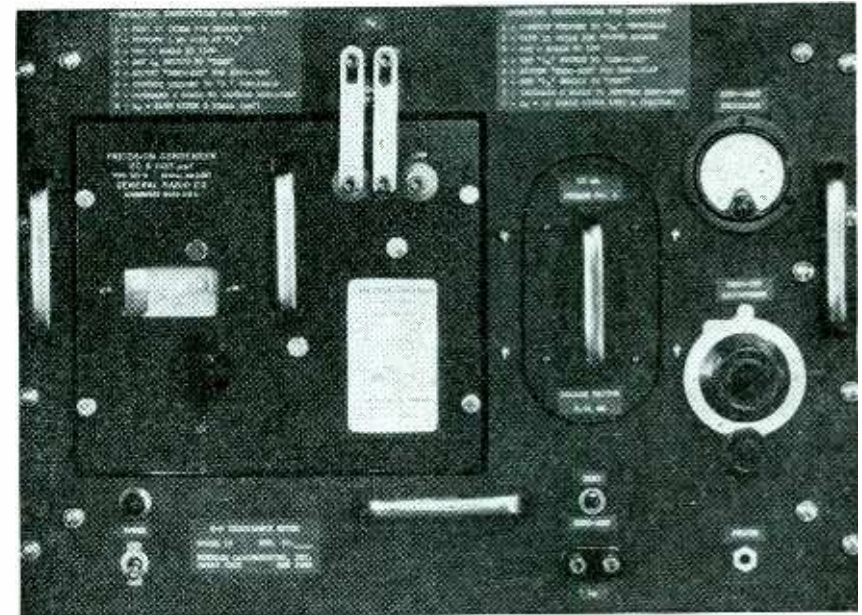

Front panel of r-f inductance meter. Plug-in standard inductances are stored in rack above meter, not shown

frequencies whose values are chosen for convenience and reliability.

Beat-Note Circuit

The block diagram in Fig. 1 shows the arrangement of the inductance meter. Two similar oscillators are tuned to the same frequency by observing a zero-beat in-

dicator. Each oscillator contains a resonant circuit with fixed inductance L_0 and fixed capacitance C_0 . One oscillator also has a calibrated variable capacitor C connected in parallel. The other has provisions for connecting unknown inductance L in series.

With the standard capacitor C at its reference value (taken as zero) and the unknown inductor L on short-circuit, the two oscillators are tuned to resonance by a fine adjustment. Then the unknown L is inserted and the standard C is increased to restore zero-beat. The latter condition satisfies the equation of resonance of the two oscillators: $(L + L_0)C_0 = (C + C_0)L_0$. From this the calibration formula is derived, giving $L = CL_0/C_0$. The factor L_0/C_0 is adjusted to be a decimal multiplier, and the scale of C is direct-reading in micromi-

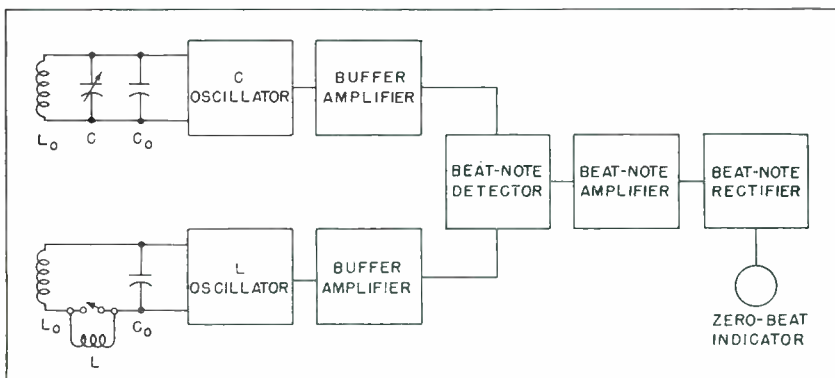

FIG. 1—Block diagram of direct-reading radio-frequency inductance meter

crofarads, so the value of the unknown L is obtained merely by shifting the decimal point.

The circuit of the r-f oscillator and buffer amplifier is given in Fig. 2. The two oscillators and amplifiers are alike except for the differences in the tuned circuit, one including the standard capacitance C and the other the unknown inductance L . The standard inductors L_0 are the pair of plug-in coils, one for each oscillator, whose values are equal to the maximum inductance of each range. Each oscillator has a regulator circuit which limits the amplitude of oscillation to a suitable value for the buffer amplifier.

The beat-note circuit is given in Fig. 3. Direct-current coupling of the amplifier to the rectifier-meter combination provides response down to very low frequencies. The full-wave rectifier causes the meter pointer to vibrate at double the beat frequency.

The response curves of the meter are shown in Fig. 4. The curve of Fig. 4A shows the wide peak obtained while tuning one oscillator past the frequency of the other, and the curve of Fig. 4B is an enlargement of the valley near zero beat.

The zero-beat indicator gives essentially a wide peak having a narrow valley in the center. The width of the peak is $\pm 5,000$ cycles from the center, so it cannot be passed in quick tuning. The width of the valley is ± 100 cycles, the pointer vibrations are within ± 10 cycles, and the dead spot in the center is within ± 1 cycle. The wide peak is used to find the narrow valley, after which the dead spot gives a reliable indication of zero beat.

This indicator has been found well adapted for use by nontechnical personnel. It cannot be overloaded in normal use. Being visual, it neither causes nor suffers from noise in the laboratory or factory.

Test Frequencies

The choice of test frequencies which are best adapted for the usual radio coils in the respective decades of the inductance range is a compromise which fortunately is not too critical. The final selection is in-

fluenced also by the stability of C_0 and L_0 and by convenience in the use of the decimal values.

The basic value of the inductance of a simple coil in open space is determined by the magnetic energy in the vicinity of the coil but outside the cross-section of the conductor itself. If a shield can is used, this space is confined to the inside of the shield. The inductance would have this basic value if the coil and shield were made of perfect conductors, and its actual value is not much different at the higher radio frequencies.

The resistance of the wire and the shield causes an increase in the actual or apparent inductance of the coil, in proportion to the magnetic energy which is allowed to penetrate inside of either conductor and outside of the shield to the surrounding space. The internal capacitance increases only the apparent inductance, by virtue of the approach to self-resonance.

The magnetic energy in the wire increases the inductance by a constant amount at low frequencies, and by a decreasing amount at higher frequencies. The transition occurs at the frequency where the skin depth is one-fourth the wire diameter if the wires are well separated, and at a slightly lower frequency if they are close together. In the case of fine wire, such as in stranded (Litz) conductors or in multilayer coils, this effect is constant at all frequencies up to the operating frequencies, so it causes no error in inductance measurements at lower frequencies. In a coarse wire, such as the conductors of a transmission line, this effect varies slowly with frequency as governed by the skin effect, so a measurement at a lower frequency is subject to a slight error relative to the operating frequency.

A perfect shield decreases the inductance by a substantial amount, while the imperfection of the shield

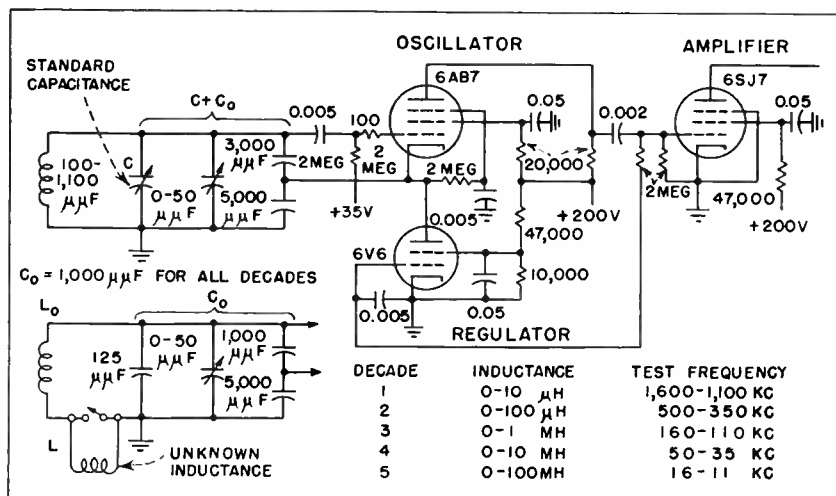

FIG. 2—Circuit for one of the oscillators with its buffer amplifier. Both are identical except for the tank circuits; one has the standard capacitance in parallel, and the other has the unknown inductance in series as shown at left

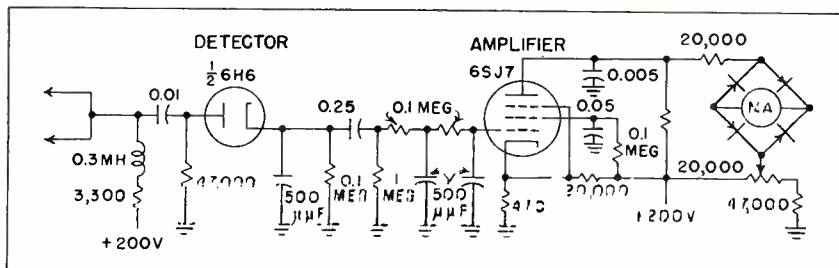

FIG. 3—Circuit of beat-note detector, amplifier, rectifier, and 0-1 ma d-c indicator serving the pair of r-f oscillators

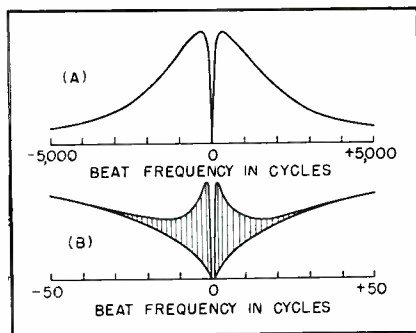

FIG. 4—Response of zero-beat indicator is shown at A, and enlarged view of valley near zero beat appears at B

conductor causes a relative increase. As the frequency is lowered, the inductance increases gradually as governed by the skin effect in the shield, then rapidly as the conductive shielding fails, and finally approaches the value of the inductance without the shield.

The internal capacitance causes the apparent inductance to increase rapidly as the frequency approaches self-resonance in the coil. This is the factor which makes impossible the direct measurement of inductance by a single observation at the operating frequency.

The best frequency for a direct measurement of inductance, with least error from all causes combined, should be much lower than the frequency of self-resonance but much higher than the frequency of shield failure. Fortunately these two frequencies are usually far apart. Three decades is a typical separation in the case of small coils in shield cans, operating around 1 mc.

The internal capacitance is the most typical characteristic for small radio coils, since it is determined mainly by the size, the leads, and the terminals. The typical range of internal capacitance is within $10 \mu\mu\text{f}$, so the inductance meter is standardized for about $5 \mu\mu\text{f}$ with a tolerance of $\pm 5 \mu\mu\text{f}$ to maintain the rated limits of error.

Since there are many causes of error and it is desired to hold the total error within one percent, the test frequencies are chosen low enough so that $\pm 5 \mu\mu\text{f}$ causes less than ± 0.25 percent error. In other words, the unknown inductance would resonate at the test frequency

with more than $2,000 \mu\mu\text{f}$ capacitance, so the test frequency is about $1/20$ the frequency of self-resonance, or lower.

Sensitivity of Measurement

The 5,000-division continuous linear scale is available only in the precision capacitor, as distinguished from the inductor and the resistor. Therefore the capacitor is the ideal variable standard in any system of measurement, and especially in a direct-reading system.

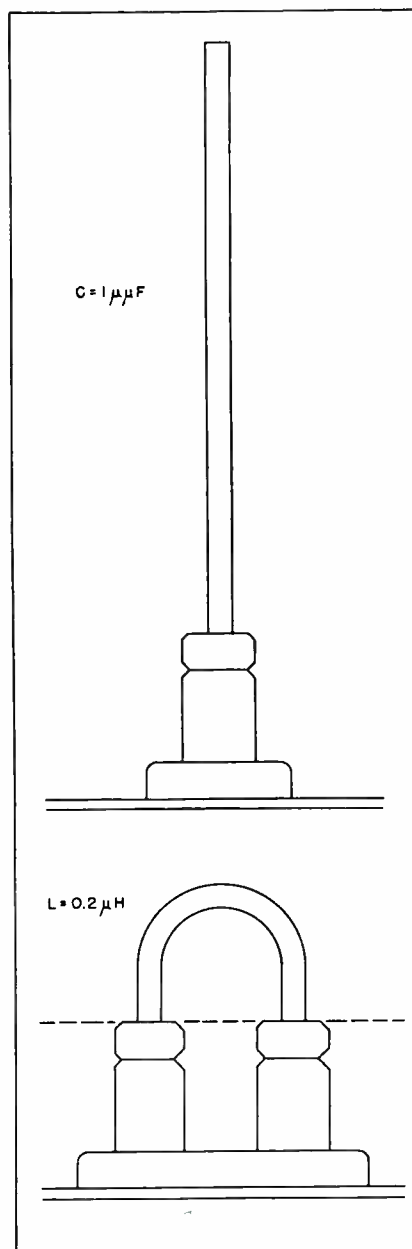

FIG. 5—Examples of small values of capacitance and inductance, shown actual size here, that can be measured with the r-f inductance meter

The inductance meter is a simple way of utilizing the capacitor to read directly in proportion to the unknown inductance.

By making the test at the highest frequency permissible for each decade of the inductance range, it is possible to take full advantage of the long scale of 5,000 divisions for $1,000 \mu\mu\text{f}$, by reading to about $\frac{1}{2}$ division or $0.1 \mu\mu\text{f}$.

In the first three decades (up to 1 mh), the test frequency is above 100 kc so it is possible to take advantage of the low range of the precision capacitor, having 50 divisions per $\mu\mu\text{f}$, or the equivalent of 50,000 divisions for full scale. This refinement is available only for a range of 4,000 divisions. Therefore it is useful for absolute measurements only to 8 percent of full scale.

By the addition of fixed capacitors in parallel, this expanded scale becomes available for differential tests of coils nearly alike. By this method, any inductors within the range of $1 \mu\text{h}$ to 1 mh can be compared to within $1/5,000$ of their values, or 0.02 percent. Any larger inductors up to 100 mh can be compared on the standard scale within $1/500$ of their values, or 0.2 percent.

Examples of the absolute sensitivity of this instrument, which is attained by the long scale and the beatnote comparison at radio frequencies, are given in Fig. 5. These diagrams are shown actual size.

The capacitance C is a small antenna inserted in the capacitance terminal. Its value is $1 \mu\mu\text{f}$, which is 5 divisions on the regular scale or 50 divisions on the expanded scale.

The inductance L is a small loop of heavy wire connected to the inductance terminals. As compared with a short-circuit (a large flat disc at the dotted line) the inductance is $0.02 \mu\text{h}$, corresponding to 10 divisions on the regular scale or 100 divisions on the expanded scale.

By indicating inductance values on the expanded scale of a precision capacitor and using r-f oscillators with a zero-beat indicator, an inductance meter is obtained which has an unusual degree of absolute and differential stability as well as high accuracy.

Built-in and outdoor antennas for f-m reception, front-end and i-f circuit arrangements, and demodulation systems are discussed in this symposium.* Included is a useful method of testing an antenna by comparing the voltage delivered at the receiver to the voltage obtained from a reference antenna

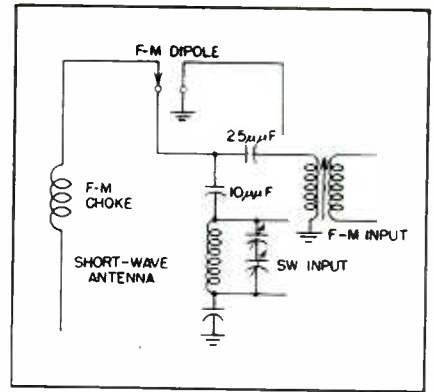
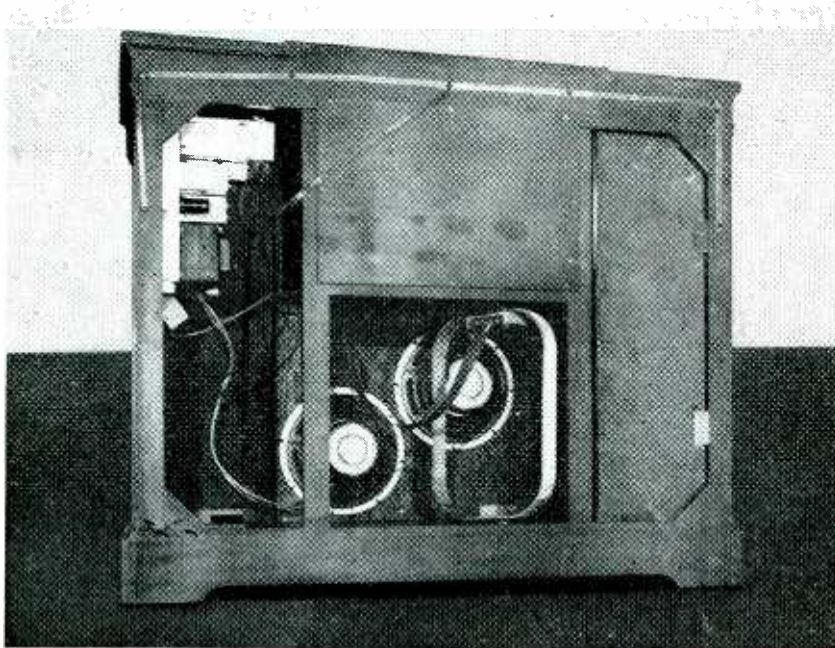

FIG. 1—Simple combination antenna covering one f-m band and short waves

F-M Reception Problems



A simple built-in f-m antenna is a folded dipole made of 300-ohm twin lead and tacked to the back of the cabinet as in this Hallicrafter receiver

THE AVERAGE USER of an f-m broadcast receiver has a right to expect that the installation and operation of his set should be no more complicated than for the standard broadcast set he bought ten years ago.

Since receivers, like population, are concentrated in cities and towns, and f-m transmitters are being located at the centers of these concentrations, f-m coverage is essentially a metropolitan or urban

*From papers presented before the Chicago Section and the Indianapolis Section of IRE

proposition. This means that although some rural areas as well as some outlying towns and villages will be served, the majority of listeners will be relatively close to the transmitters, where high field strengths prevail. For this reason, it is feasible to provide built-in antennas in f-m receivers and to expect them to operate satisfactorily in most installations.

Built-in antennas for f-m sets involve some problems that are not found in standard broadcast sets. This is so because the buildings in

which the sets are used are large compared with the wavelength. The dimensions of the rooms in which sets are used, and even the dimensions of the radio cabinets, are comparable with the wavelength. Therefore, large standing wave patterns are frequently found to exist, and small differences in the position of the radio set within a room, or even the position of people moving within the room, may make a relatively large difference in the received signal strength.

This means that the performance of built-in antennas is variable, and one type may perform well in a particular location while another type will perform better somewhere else. In most metropolitan locations the signals are strong enough that these problems are completely cared for by the limiter of a sensitive receiver.

Double Antenna

Figure 1 shows one type of built-in antenna. It is a dipole constructed of wire and fitted to the inside of a console. The arms of the dipole are bent or folded so that they will fit into a cabinet of reasonable size. The antenna shown in this figure also includes a length of wire used for shortwave reception. This wire is isolated from the dipole by means of a choke having high impedance to the f-m frequencies and relatively low impedance to the short-wave frequencies. The receiver has separate input circuits

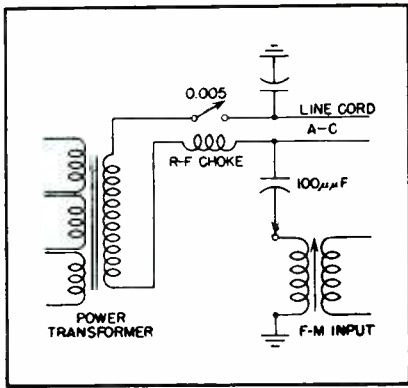

FIG. 2—Circuit for a line-cord antenna suitable for reception of f-m signals

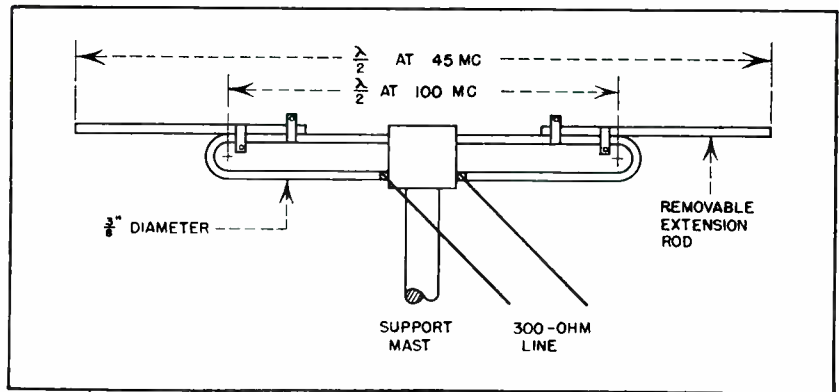

FIG. 3—Mechanical arrangement of antenna elements for reception on both the old and the new bands

and Their Solution

for f-m and shortwave, and these are tied together at the antenna terminals by means of a network which prevents undue loading of one circuit by the other.

Another form of built-in antenna is shown in Fig. 2. This is the familiar line-cord antenna adapted to f-m reception. Since one side of the line cord must be bypassed to reduce line noise in the broadcast section of the receiver, it is essentially the signal voltage between the two conductors of the line cord which is used as input to the f-m circuits.

In some locations the cabinet dipole will work better, and in other locations the line-cord antenna will work better. Since they are inexpensive, both can be provided in a console f-m set and the user may select the one which works better in his location. Table model radios are generally too small to accommodate the cabinet dipole, and for this application the line-cord antenna is preferable. Both of these antennas provide good reception on the low and high f-m bands.

Both F-M Bands

In outlying districts where built-in antennas do not give satisfactory performance, a several-fold improvement may be had by using a simple outdoor antenna with low-loss leadin. Figure 3 illustrates such an antenna which works satisfactorily on both the old and the new f-m bands. This antenna consists of

a 100-mc, half-wave folded dipole fitted with extension arms that build up the length to a half wavelength at 45 mc.

The efficiency of the antenna is somewhat better on the low band than on the high band. If low-frequency f-m broadcasting should be discontinued or the band changed, the extension rods can be discarded and the antenna will function with full efficiency on the high band only.

With an outdoor antenna the performance is much less variable than with a built-in antenna. It becomes meaningful to measure the performance and obtain curves showing the effect of frequency over the band in which we are interested. There are several characteristics of antennas that permit critical measurements for the purpose of comparison. For example, it is important in television antennas that the impedance closely match the impedance of the transmission line at all the operating frequencies. This measurement may be expressed by a curve of impedance against frequency, standing-wave ratio of reflection coefficient, or attenuation due to mismatch. Antennas may also be measured in terms of their directional patterns or signal gain.

For f-m service, impedance matching is not a major consideration. It is quite satisfactory to test an antenna in terms of voltage delivered to the receiver. In doing this it is convenient to compare the

Antennas for F-M Receivers

By NATHAN W. ARAM

Engineering Department
Zenith Radio Corporation
Chicago, Illinois

R-F, I-F, and AFC Circuits

By LLOYD M. HERSHEY

Engineer-in-Charge
Home Receiver Division
The Hallicrafters Company
Chicago, Illinois

Limiters and Frequency Detectors

By MARVIN HOBBS

Consulting Radio Engineer
Chicago, Illinois

voltage with that obtained from a standard or reference antenna. The common reference is a resonant half-wave dipole. The setup for making this test may be of interest, and Fig. 4 shows the method used in obtaining a curve for the two-band antenna just shown.

Test Technique

Tests are made using the antenna for receiving. At each frequency an arbitrary field is set up by a third antenna connected to an oscillator some distance away. The reference antenna is then adjusted to resonant length, placed in the test position, and the voltage V_1 delivered to the matched load is noted. The reference antenna has an impedance of approximately 70

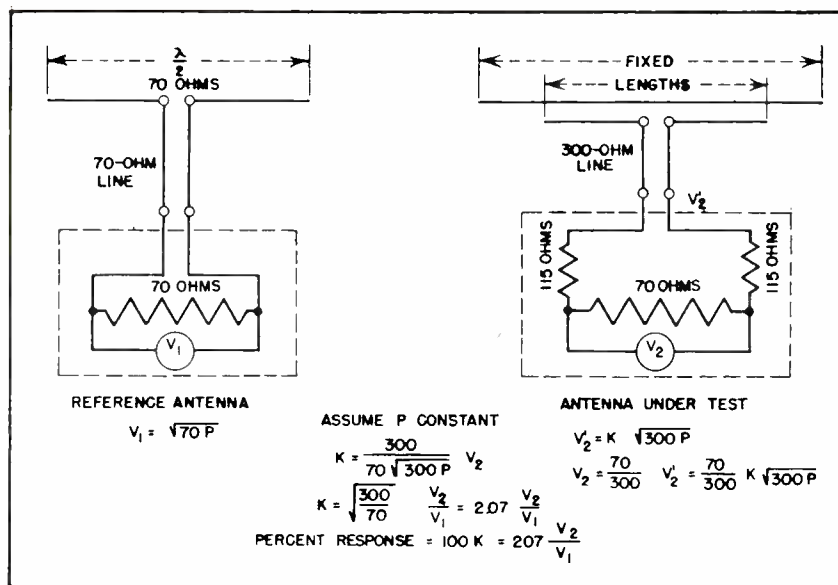

FIG. 4—Method of comparing the two-band antenna against a resonant dipole

ohms, the transmission-line characteristic impedance is 70 ohms, and the load impedance is 70 ohms. The load consists of the input attenuator of a field intensity meter.

The antenna under test is then substituted for the reference antenna at the test position. Since the receiver for which this antenna was designed has an input impedance of 300 ohms, 300-ohm transmission line is used and the field intensity meter input is built up with resistors to match the 300-ohm line. When this is done the field intensity meter input circuit duplicates an ideal receiver input, but the voltage indicated by meter V_2 is equal to only 70/300 of the voltage delivered to the receiver.

By comparing readings V_1 and V_2 of the field intensity meter, the performance of the antenna under test is related to the performance of the standard antenna. Here it is assumed that the power delivered to the receiver by the standard antenna is the maximum power available from the antenna under test, and the fraction of the available power actually obtained is a figure of merit for the antenna. Since receiver measurements are made in terms of voltage rather than power, it is the square root of this figure or the voltage ratio K which is actually used.

After this measurement has been made at a number of frequencies, a performance curve can be plotted. This is shown in Fig. 5. In judging

this curve, it should be borne in mind that the reference antenna has been readjusted in length for each frequency. Plotted in this same manner, a simple dipole of fixed length would show considerable selectivity while a simple folded dipole would be relatively broad and comparable to the low-band performance curve shown. If the extension arms of the two-band antenna were removed, the high-band curve would look very similar to the low-band curve as plotted, but the low-band curve would suffer seriously.

Experience indicates that built-in antennas of the line-cord and cabinet dipole types give satisfactory set operation at practically every location in the Chicago metropolitan area on either the low or high bands. At distances of about forty miles, a simple outdoor antenna becomes useful in many installations; and at greater distances, approaching the nominal service area limit, the outdoor antenna is required in all but exceptionally good locations.

R-F and I-F Circuits

In considering the circuit elements between the antenna terminals and the output of the i-f amplifier, it must be noted that the best distribution of gain in an f-m receiver is determined largely by noise considerations. A certain amount of noise is produced by thermal agitation in the antenna circuit. If the maximum signal-to-

noise ratio is attained in the antenna circuit and the amount of noise added in later stages is very small compared to that in the antenna circuit, the signal-to-noise ratio of the receiver can be made to approach (as a maximum) the ratio established in the antenna circuit.¹

The maximum antenna stage gain is $0.5\sqrt{Z_1/Z_2}$ where 0.5 accounts for matching to the source impedance; Z_1 is the impedance into which the antenna transformer works, and Z_2 is the source or transmission-line impedance. It is assumed that the impedance of the secondary of the antenna transformer is considerably greater than the input loading of the tube, which is usually the case, in a receiver using an r-f stage.

Input Stage

The r-f amplifier tube is chosen primarily on the basis of low input conductance, low noise, fairly high mutual conductance, low grid-to-plate capacitance, and low cost. In an a-m/f-m receiver, signal-handling ability with AVC applied may be an important consideration. Since these factors are not combined in any single tube, the final choice represents a compromise.

The maximum stable r-f stage gain in a variable-capacitor tuned stage having a solid rotor shaft is about 10 times. If the antenna and r-f circuits are isolated from each other as in permeability-tuned receivers, somewhat greater r-f stage gains can be safely realized.

The amount of r-f stage gain required depends upon the relative amounts of noise at the r-f tube grid and the mixer grid. If the same type of tube is used as r-f amplifier and converter, the mixer tube noise voltage is approximately two times the r-f amplifier tube noise. To avoid any substantial decrease in the signal-to-noise ratio, therefore, a gain greater than five times is required in the r-f amplifier stage.

The noise voltage developed in a mixer tube depends largely upon the type of tube used and its mutual conductance. Of the commonly used types of mixer tubes, the pentagrid converter is the noisiest, the pentode is less noisy (and frequently a good compromise) and the triode is the quietest. The diode, and

better still, the crystal mixer, are extremely quiet; however, stage gains less than unity are common using these mixers, and a quiet first i-f stage amplifier tube is required if either is used.

The oscillator stability and tuning accuracy requirements for an f-m receiver are considerably greater than for an a-m broadcast receiver. The a-m receiver must be tuned within about ± 2 kc in a 1,000-kc band (or the dial must be set to about ± 0.2 percent) if noticeable distortion is to be avoided. The f-m receiver must be tuned within about ± 20 kc in a 20-mc band, or about ± 0.1 percent. The oscillator must be stable to within about two parts per thousand in the standard band, and to about two parts per 10,000 in the f-m band.

AFC Circuit

The nature of the oscillator stability and tuning accuracy problems make the use of automatic frequency control on the f-m band attractive. If the oscillator and mixing functions are performed in separate tubes, afc can be provided by adding a few resistors and capacitors, and by using a dual-triode tube as the oscillator and reactance tube. Such a system is used in several Hallicrafters home receivers.

A circuit of this type is shown in Fig. 6. The plate of the oscillator is capacitance coupled to the grid and plate of the reactance tube. The resultant voltage on the grid of the reactance tube is shifted in phase approximately 45 degrees by resistor R_1 , capacitor C_2 , and the capacitance from the reactance tube grid to ground. This voltage is then amplified by the reactance tube according to the value of direct voltage on its grid and appears as a current in the oscillator plate feedback winding, shifted in phase from the oscillator plate current by about 135 degrees. The d-c component of the output of the frequency detector can be used as the control voltage applied to the grid of the reactance tube.

The slope of the reactance-tube characteristic can be adjusted so that the afc system takes hold and releases within the frequency limit of the next adjacent local channel

(400 kc), and a correction of about five to ten times on the oscillator mistuning can be realized. Under these conditions, the afc operation prevents the receiver from reproducing the two spurious responses, which occur on each side of the desired response points in a receiver without afc.

I-F Amplifier

The i-f amplifier in an f-m receiver is required to produce a major part of the total gain and the selectivity of the receiver. The selectivity is usually made as great as possible without harmful effects upon the signal; that is, when the f-m signal swings back and forth on the curve of the i-f selectivity characteristic, the result is amplitude modulation. The limiter or detector must be able to remove this a-m and restore the signal to its original form to avoid distortion in the audio output. At the same time, a small amount of phase distortion is produced due to the non-linear phase characteristic of the i-f amplifier when the sidebands of the signal are too far from the center frequency in terms of the bandwidth of the amplifier. As a practical matter, the amplitude variations in a typical i-f amplifier are far more troublesome than the lack of linearity of the phase characteristic.

In the most popular design for i-f amplifiers, the bandwidth of the amplifier is made about equal to the total deviation. This seems to include an adequate allowance for error in tuning, oscillator drift, and other factors in a well designed receiver. Each i-f transformer consists of a pair of tuned circuits coupled to slightly less than critical coupling, so that normal variations in coupling can be allowed in production without some transformers being over-coupled.

It is the usual practice to make the Q of the primary equal to that of the secondary, since the pass-band is too narrow to allow any appreciable improvement in gain with practically obtainable ratios of Q. Moreover, unequal values of Q for the primary and secondary cause

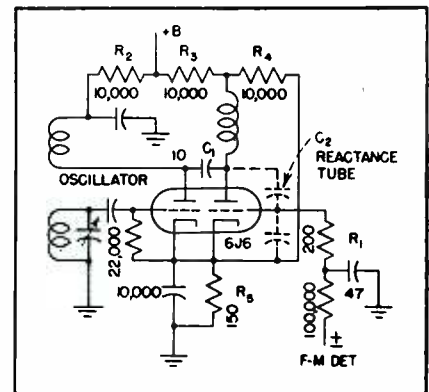

FIG. 6—A tuned-grid oscillator and afc reactance-tube circuit

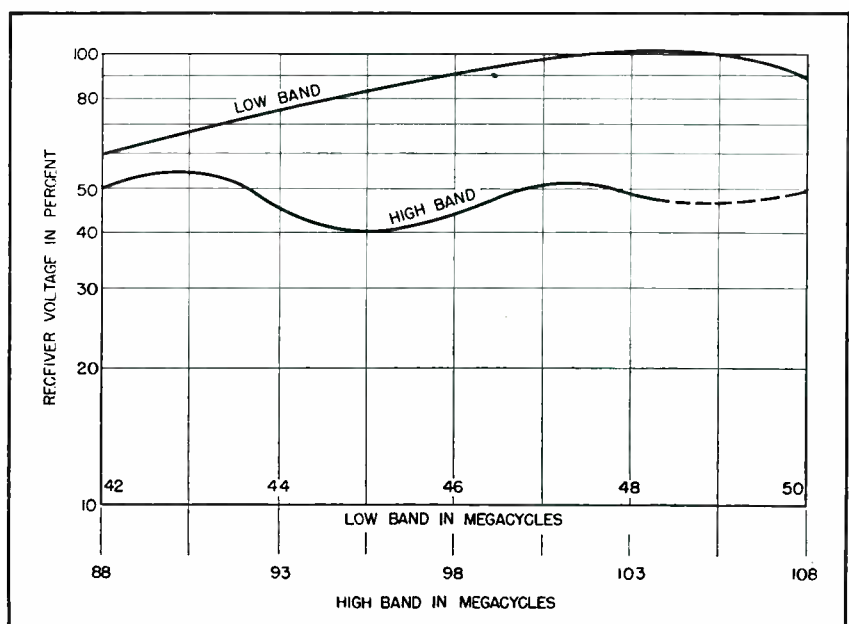

FIG. 5—Receiver voltage for a two-band antenna with 300-ohm line feeding into a 300-ohm input compared with a matched-impedance resonant dipole

asymmetry of the amplitude and phase characteristics when either primary or secondary is detuned relative to the other circuit.

The gain of the i-f amplifier is usually made as high as cost and stability considerations will permit. If maximum sensitivity is to be realized, an optimum value seems to be enough gain to assure saturation of the limiter (or a comparable noise value at the ratio detector). This allows satisfactory reception of any signal which is of sufficient intensity to overcome the noise voltage at the limiter or ratio detector. A margin of about 10 db over the i-f gain required to produce this saturation by noise is needed to insure maximum performance under all conditions.

Maximum stable stage gains may be computed by means of a formula given below.² It is usually advisable to limit the stage gain to somewhat less than one-half of the calculated value for safety.

$A = \sqrt{\frac{g_m}{\omega C_{pg}}}$ (multiply A by $1/\sqrt{n}$ for n stages) where A = maximum stage gain, g_m is in micromhos, ω is in radians per second, and C_{pg} is the effective plate-to-grid capacitance in farads.

High-Capacitance Grid Circuit

There is one departure from conventional i-f transformer design that has been developed recently. The usual value of tuning capacitance on an i-f transformer primary or secondary is about 50 $\mu\mu\text{f}$ or less. The input capacitance of the commonly used tubes varies about 2 $\mu\mu\text{f}$

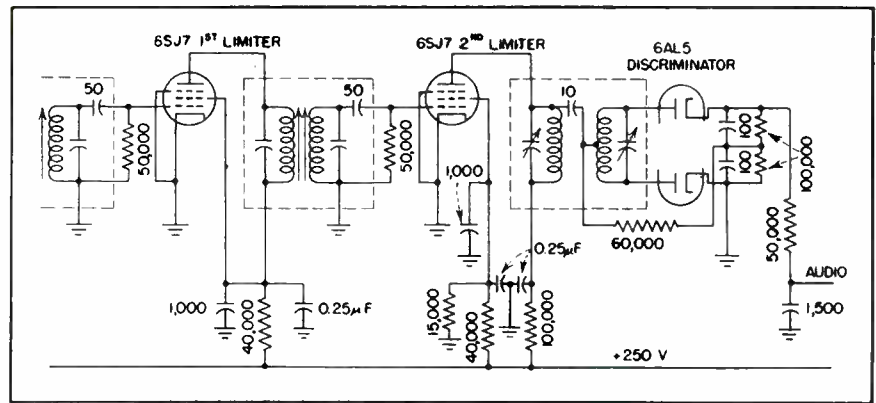

Receiver circuit with a double limiter and a discriminator. Capacitor values in $\mu\mu\text{f}$ unless otherwise noted

when the grid voltage is varied from the normal bias value to cut-off. This means that impulse-noise voltages on the last i-f amplifier tube or limiter tube can produce detuning of the i-f transformer secondary, and thereby introduce phase distortion in the signal. The limiter removes most of the amplitude modulation of the carrier due to the noise pulse, but it cannot remove the phase distortion. Remarkable improvements in signal-to-noise ratio have been reported when the secondary tuning capacitances in the last i-f and limiter grid circuits were increased.

The gain of a double-tuned i-f stage is inversely proportional to the square root of the product of the values of the tuning capacitances. This suggests that, since the tube output capacitance is substantially constant, the stage gain obtained from a symmetrical transformer can be duplicated with only the output capacitance and strays

tuning the primary, and the secondary capacitance increased by the same ratio by which the primary capacitance was decreased. It is desirable to keep the Q of the primary equal to that of the secondary.

Three types of wide-band f-m detector systems have appeared in production receivers since the war, namely—the limiter-discriminator combination, the ratio detector and the locked-in oscillator. For practical considerations, it seems best to evaluate these systems in terms of the overall performance of the various receivers in which they are employed. However, the detector is often blamed unjustly for the poor performance of receivers in which cost considerations have led to sacrifices throughout the complete circuit. All of the systems mentioned have certain disadvantages as well as their own peculiar advantages. Any of above systems can be made to perform quite satisfactorily.

The Limiter-Discriminator

It has become customary to employ two grid-plate limiters in cascade in the more elaborate receivers using this system. The parameters for each limiter are adjusted so that the maximum range of linearity without appreciable change of output level is realized. Grid circuit constants are chosen to provide a low time constant for optimum limiting of impulse noises.

Since adequate gain must be provided ahead of the limiters to realize full action at low antenna input levels, they are usually preceded by two i-f stages, a mixer, and one r-f stage, preferably with separate

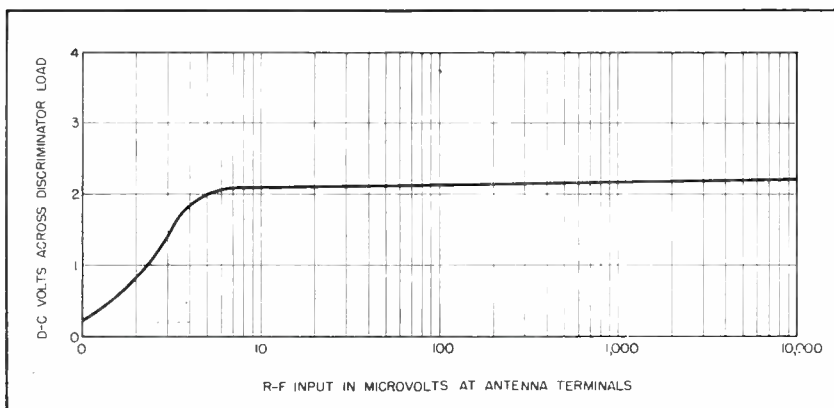

Input-output characteristic of a sensitive limiter-type receiver which shows that practically flat response may be obtained without the use of avc. The long flat portion at high signal levels indicates ability to handle downward modulation. Curve obtained with carrier deviated ± 50 kc from center frequency of detector

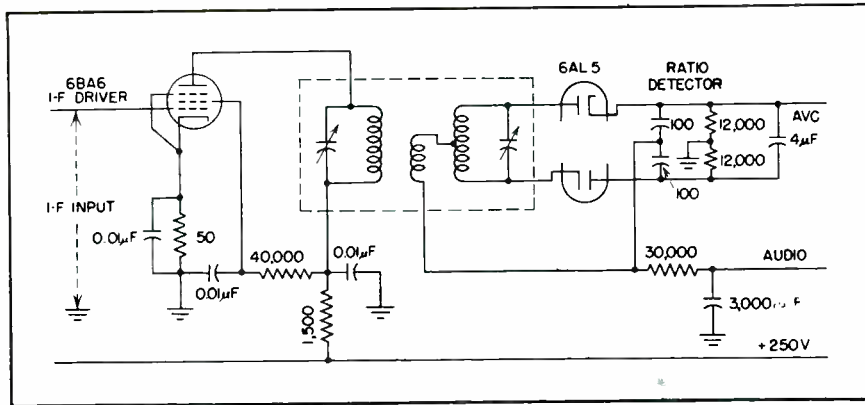

Ratio detector system for an i-f receiver employing a transformer having a tertiary winding

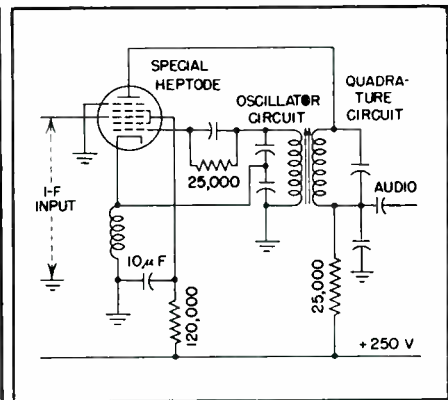

Simplified circuit of the lock-in oscillator and quadrature detector combination

tubes to furnish maximum gain. Lower priced receivers often employ a single limiter, which results mainly in a loss of overall sensitivity and a limitation of the range of signal levels over which amplitude modulation is fully suppressed.

The main factors considered in the selection of proper constants for the discriminator include an adjustment of the primary to secondary coupling and circuit Q to provide the optimum degree of linearity throughout the working range of the detector. Circuits employing either variable capacitance or variable inductance tuning have been developed.

The limiter-discriminator combination has the advantages of being unaffected by modulation variations within the operating range of the limiter and of being relatively non-critical in so far as discriminator linearity and balance are concerned. It has the disadvantages of requiring a high gain before the limiter and of a broadening selectivity characteristic with increasing signal level.

Ratio Detector

Due to the inherent ability of the ratio detector to suppress amplitude modulation at comparatively low input levels, it offers a desirable opportunity to those who wish to incorporate reception facilities at a minimum cost. This characteristic is particularly advantageous in those receivers employing common r-f and i-f amplifier tubes for both the a-m and f-m channels and has led to the production of complete a-m/f-m receivers incorporating as few as seven tubes. If the ratio de-

tor is properly designed these receivers can provide acceptable performance. Unfortunately, many of them do not suppress amplitude modulation or provide low distortion levels.

One chief requirement for the proper suppression of amplitude modulation is careful balancing of the two diode circuits. The use of bifilar secondary windings of high Q and a proper choice of circuit constants can produce very beneficial results in this respect. The required linearity for low distortion is not difficult to obtain with a well balanced circuit, but many production sets suffer due to excessive selectivity ahead of the detector. The i-f selectivity often varies due to regeneration or coupling coefficients not controlled in low-cost receivers, resulting in high downward modulation during wide frequency swings and considerable distortion.

These difficulties with the ratio detector can be overcome provided a careful design is made and a high degree of quality control is exercised in production. The chief advantage of the system is its ability to suppress amplitude modulation at lower signal levels than is possible with limiter sets.

The main disadvantages are the problem of handling high percentages of downward modulation, produced by multipath signals and excessive selectivity, and the fact that AVC voltages must be applied to several high-frequency stages with the possibility of shifting their tuning and the symmetry of the selectivity characteristic.

These disadvantages can be overcome to a great degree if the audio

output requirements for the detector are reduced and provided enough i-f stages can be employed to allow the use of high grid circuit capacitances in the amplifier circuits which are automatically biased.

Locked-in Oscillator

The locked-in oscillator operates in a manner similar to the double limiter arrangement throughout the lock-in range of the oscillator, but it may distort badly when the signal level drops below the lock-in threshold. It has been employed by one manufacturer commercially and in several forms experimentally, such as the use of a submultiple oscillator to convert to narrow band f-m before detection and the use of combined oscillator-detector circuits.

In general the advantages and disadvantages are of the same general nature as those of the limiter system. An important consideration is the necessity for eliminating any extraneous frequency or phase modulation of the locked-in oscillator by filament, screen or plate voltage variations.

The locked-in oscillator has the inherent capability of being less susceptible to interference than any of the three systems described, but practically its entire performance depends on the degree to which the oscillator can stay ideally locked to the desired signal.

REFERENCES

- (1) E. W. Herold, An Analysis of the Signal-to-noise Ratio of Ultra-high-frequency Receivers, *RCA Rev.* 6, Jan. 1942; D. O. North, The Absolute Sensitivity of Radio Receivers, *RCA Rev.* Jan. 1942.
- (2) J. R. Nelson, *Proc. IRE*, Feb. 1929.

R-F Operated

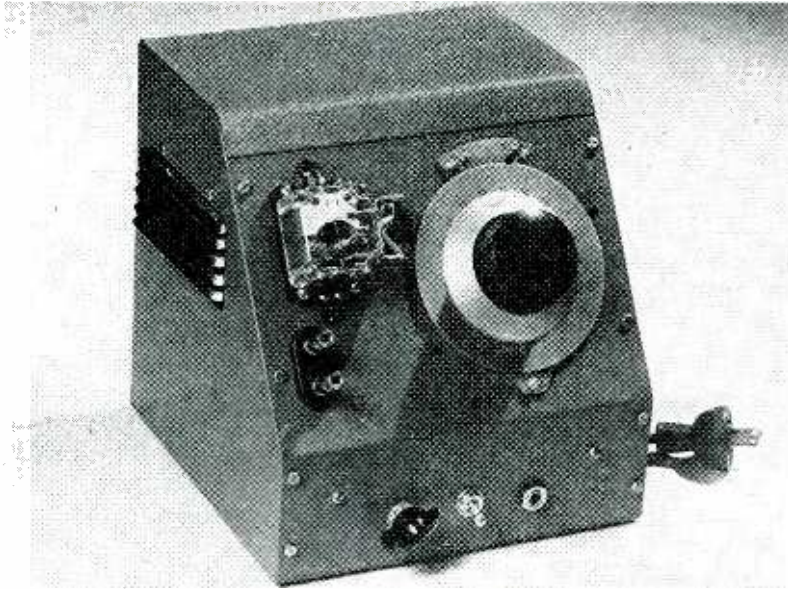

FIG. 1—External appearance of the carrier-operated relay. Shown on panel are the antenna terminals, micro-relay, tuning control, and (at bottom) sensitivity switch, automatic reset switch and jack for headphone monitoring

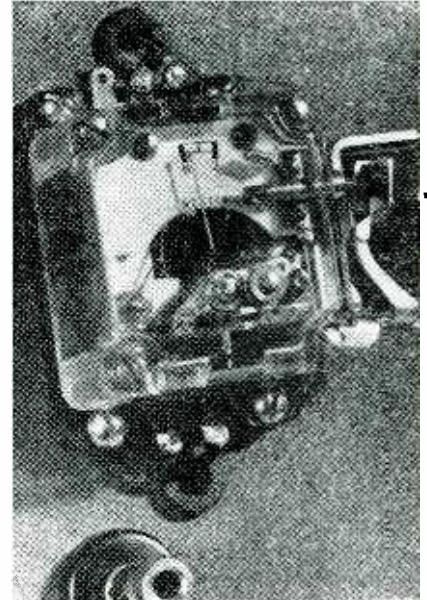

FIG. 2—Close-up view of Weston micro-relay, which closes on 2 microamperes d-c, supplied by tuned circuit and crystal

WHENEVER it is necessary to control a relay at a remote unattended location (a problem which often arises in communications and industrial technology), the supply of standby power assumes importance. If power is available, a relay controlled by a continuously operating radio receiver suffices, but the reliability of such a system is always in some question because of possible failure of power supply or tubes. If a high degree of reliability is required, and if power is at a premium, a wire control circuit is often pressed into service despite its high initial cost.

Several months ago it occurred to the writer that the reliability and economy offered by the wire circuit could be achieved by radio control, provided that all standby power were eliminated in the receiver and sufficient sensitivity achieved to permit operation at reasonably long distances.

The combination of a crystal detector and a sensitive microammeter-type relay suggested itself as a possible solution to the problem. Accordingly available relays of this type were investigated.

The most sensitive device available is the meter-type relay which closes a circuit by magnetic attraction between contacts on the meter pointer and the pointer stop. One such meter-relay, the Weston model 813, closes with a current of 2 microamperes through a 1000-ohm coil, which represents the minute power consumption of 0.004 microwatt. It will carry a contact current of 50 milliamperes, which is more than sufficient to actuate a rugged power relay.

Expressed in voltage, the relay will close with 2 millivolts, d-c. Combined with a silicon or germanium crystal rectifier, such a relay will respond to an r-f excitation of from 5 to 15 millivolts, depending on the detection efficiency. Since a 100-watt transmitter will produce a 10-millivolt-per-meter field at about 5 miles, under ground-wave conditions, or at vastly greater distances when skywaves are called into play, it would appear that such sensitivity would serve in many applications.

Among the uses to which such a carrier-operated relay might be put are: a carrier-failure alarm which requires no power while

monitoring but which will sound an alarm when the carrier disappears for any period longer than a second or so; a ringing device for radiotelephone circuits to remote locations having limited power resources, such as fire towers; a switch for turning on any remotely located electrical device (transmitter, receiver, photoelectric illumination control, and others) when the periods of operation are so widely spaced that standby power is of economic importance.

Relay Specifications

The device, as finally constructed, responds to antenna current with a sensitivity of approximately 10 millivolts, r-f, and tunes over the broadcast and medium frequency spectrum from 700 to 2,300 kc. This frequency range was selected because of the desire to test on sky-wave signals, and because many high-powered transmitters occupy this region. Operation at 30 or 40 mc is equally feasible, merely by changing the coils, and is perhaps preferable when the effects of interference are considered. The device consumes no power whatever

Remote Control Relay

Consuming zero standby power, microsensitive relay responds directly to the current in a receiving antenna, closing on 8 to 10 millivolts, r-f. Useful in many applications at unattended locations or as a carrier-failure alarm

By DONALD G. FINK

while in the standby condition. The final control is exercised by a power relay with 10-ampere contacts, which draws four watts of coil current when actuated from a 115-volt line.

The microsensitive relay closes through magnetic attraction, and it remains closed until reset. Since unattended operation is required, an automatic thermal resetting arrangement is provided. When the relay is actuated, it remains closed for from 10 to 60 seconds, and then automatically resets to the standby position. If the control carrier is present continuously, the device continues to recycle until the carrier is removed, thus providing a recurring closure particularly suitable to ringing applications. The device may also be reset manually and the reset mechanism may be disconnected if it is desired that the relay remain closed after the initial actuation.

By adjustment of the tension of the meter-relay coil spring, the microsensitive relay may be operated with contacts normally open or normally closed. In the normally-open position, the relay remains inactive until the control carrier signal appears. In the normally-closed position, with the rectifier polarity reversed, the relay is held open by the presence of the carrier, and closes (actuating the power relay) only when the carrier is interrupted.

Since signals of widely varying strength may be encountered, a sensitivity control must be provided. This is an adjustable shunt across the sensitive relay which reduces its sensitivity by a factor of 10, 100 or 1000 times. A jack is provided so that the station tuned

in can be identified by listening with headphones.

In designing the r-f portion of the carrier-operated relay, a choice had to be made between sensitivity and selectivity. It was decided to design for maximum sensitivity, which implies loading the tuned circuit with the low (1,000-ohm) resistance of the meter-relay coil. This heavy loading reduces the overall Q of the two-circuit tuning system to about 7. Consequently the resonance curves (Fig. 5) display a width of about 100 kc at 6 db down at 650 kc, which is not sufficient to separate stations in the broadcast band. This is not a disadvantage if the control signal is substantially stronger than those of adjacent stations, which is ordinarily the case when the device is used as a carrier alarm.

For operation at a fixed frequency a larger number of tuned circuits might also be employed to increase the selectivity, although such a system would be difficult to track over an extended tuning range.

Construction and Circuit

The external appearance of the carrier-operated relay is shown in Fig. 1. The pointer of the meter-relay can be viewed as a tuning indicator. In operation, the sensitivity switch (bottom, left) is set to the minimum position and the tuning dial set to the frequency of the control signal. The sensitivity switch is then rotated clockwise until the meter pointer swings and the magnetic contact points (Fig. 2) close. If the reset switch (bottom, center) is in the upper posi-

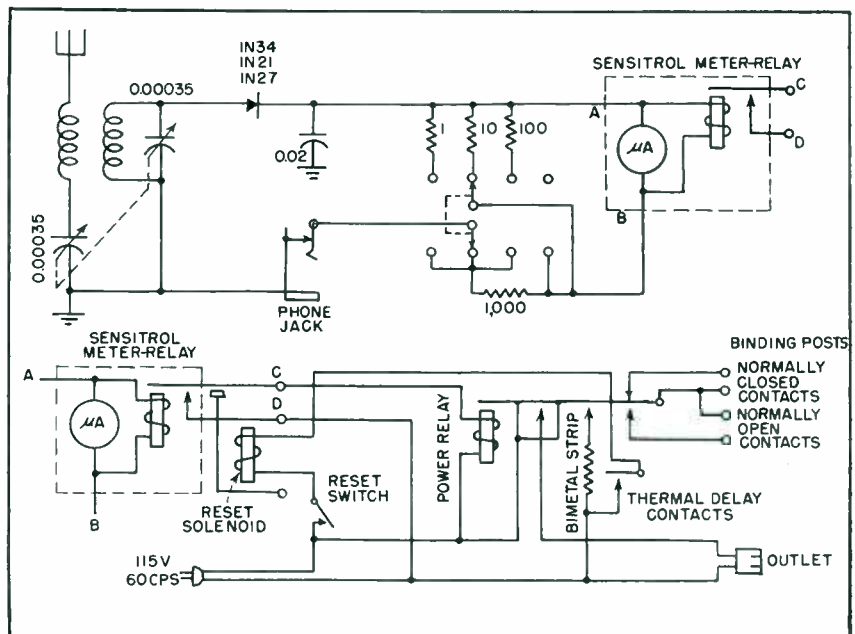

FIG. 3—Circuit diagram of the remote control device. An a-c operated power relay (at bottom), actuated by the micro-relay, closes when the signal is received or removed. A thermal contact resets the relay after 10 to 60 seconds

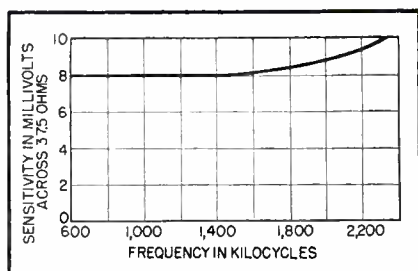

FIG. 4—Sensitivity curve, showing input r-f voltage required to actuate relay at various frequencies from 700 to 2,300 kc. Other frequency ranges can be accommodated with the same sensitivity

tion, the relay remains closed indefinitely until the magnetic contacts are separated by manually operating the reset armature to the right of the relay. If the reset switch is in the down position, the thermal reset comes into play and the relay is reset automatically by the solenoid. The relay thereafter remains inactive until the carrier again appears. If the carrier is still present, the relay recloses cyclically until the carrier is removed.

The circuit diagram is shown in Fig. 3. The tuning system consists of two ganged 0.00035 μ f capacitors, tuning the antenna circuit in series and the secondary in parallel. This provides a low-impedance input (about 50 ohms). The coils are universal-wound pies, each the secondary of a standard broadcast-band r-f antenna input transformer. The coupling between the two coils is varied until maximum sensitivity is achieved at both ends of the tuning range. The crystal rectifier is not critical. The 1N34 germanium diode serves well, although somewhat greater sensitivity (about 25 percent greater rectified current) may be obtained from selected silicon crystals of the 1N21 or 1N27 type. The 0.2 μ f bypass to ground adds about 50 percent to the rectified current.

The sensitivity switch consists of three resistors switched by a two-circuit rotary switch. To keep the loading (and hence the selectivity) constant on all positions of the switch, a 1,000-ohm resistor is switched in series when the low-resistance shunts are across the micro-relay. If constant selectivity is not desired, the sensitivity may be reduced by switching se-

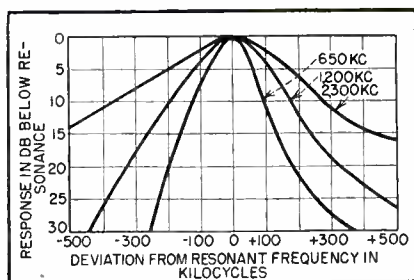

FIG. 5—Selectivity curves at various frequencies. The low selectivity is inherent in the small number of tuned circuits and the heavy loading. Higher selectivity can be obtained at some loss in sensitivity

ries resistance, which will increase the selectivity as the sensitivity is lowered.

The switch employed should have positive action and should short over from one contact to the next as it is rotated so that the micro-relay is not left unshunted between the low-sensitivity positions. This precaution is necessary when strong r-f signals are encountered, since the 2-microampere coil of the micro-relay may be burned out by currents in excess of one milliamper.

Testing Sensitivity

Testing of the r-f and micro-relay portions of the device is readily carried out with a standard signal generator having a low-impedance output. The measured r-f input required to close the meter relay at various frequencies is shown in Fig. 4. A measurable movement of the meter pointer can be achieved with as little as 2 millivolts r-f input, and the sensitivity of closing can be increased by setting the coil-spring of the meter movement so that the pointer rests, with no current flowing, on the 1-microampere scale division. This adjustment is not recommended, however, since the reliability is somewhat impaired.

The power-relay portions of the device are shown at the bottom of Fig. 3. The micro-relay contacts (repeated at the left in the diagram) close the 115-volt circuit across the power relay coil (Advance type 304B with thermal reset). The power relay contacts thereupon close, applying the 115-volt circuit to an outlet receptacle at the right, and operating independent normally-open and nor-

mally-closed contacts connected to binding posts. When the power relay closes, another contact applies the 115-volt circuit to the thermal reset, a resistance coil wound on a bimetal strip. After a period of from 10 to 60 seconds (adjustable by the setting of the contact screw) the bimetal flexes, closing the 115-volt circuit to the micro-relay reset solenoid, which resets the micro-relay. A toggle switch in series with this circuit may be opened to disable the reset circuit.

When used as carrier-failure alarm, the polarity of the crystal rectifier is reversed, and the tension of the micro-relay coil spring is adjusted, by turning the screw on the front face of the relay mount, until the magnet contacts close solidly in the absence of the current. When no carrier is present, the relay then continues to close and reset in the normal fashion. When a carrier of sufficient strength is applied, the reverse current holds the micro-relay contacts open against the tension of the coil spring and the meter remains in the standby position so long as the carrier is present in sufficient strength. Since the time constant of the meter movement, under normal current of 2 to 10 microamperes, is of the order of a second, any interruption of the carrier of this or longer duration actuates the relay, followed by a reset at 10 to 60 seconds.

The sensitivity is remarkable when judged by the usual performance of crystal-detector receivers. The relay will close on signals which are just barely audible in high-sensitivity (Baldwin-type) headphones. It will close solidly on the signal from a 50-kilowatt broadcast station located at 7 miles, when a finger is touched to the antenna binding post. A long aerial (130-foot dipole) provides such a high level of signal that selectivity is the chief problem. The cost of the parts, at current prices, is approximately 50 dollars. Readers are invited to correspond concerning possible uses of the device and variations of the design to meet specific applications.

Adjustable-Bandwidth F-M Discriminator

Use of a cathode follower in place of the pentode amplifier normally used to drive a Foster-Seeley discriminator provides easily adjustable bandwidth control, output-frequency characteristics complementary to the frequency-voltage characteristics of stabilized f-m microwave oscillators, and freedom from critical adjustments

By **W. G. TULLER** and **T. P. CHEATHAM, Jr.**

*Research Laboratory of Electronics
Massachusetts Institute of Technology
Cambridge, Massachusetts*

IN THE COURSE OF research on communication systems, the need arose for a discriminator to be used in frequency-modulation receivers having variable bandwidth. Almost simultaneously the mathematical analysis of a typical discriminator circuit showed a possibility of constructing a discriminator whose bandwidth would be readily adjustable by means of a tap switch, but whose output—frequency characteristics would have a shape independent (in normalized coordinates) of discriminator bandwidth.

This discriminator circuit has proved considerably more tolerant to misadjustment than conventional types, and has four other significant features: (1) the bandwidth is adjustable over more than a four-to-one range by means of a single tap switch; (2) the normalized output voltage-frequency characteristic is independent of bandwidth; (3) the normalized output voltage-frequency characteristic may be made the complement of the frequency-modulating voltage characteristic of a frequency-modulated stabilized microwave oscillator, thereby making possible very good overall system linearity; (4) the circuit is not

as critical to slight mistuning as most other discriminators (particularly in mistuning the primary).

The discriminator has three compensating undesirable features: (1) one additional high- g_m tube may be required as compared to other discriminators; (2) sensitivity (output volts per megacycle of frequency deviation) is an inverse-squared function of bandwidth while peak output voltage is an inverse function of bandwidth; (3) larger bandwidths are required for a given amount of distortion than

in the case of the Foster-Seeley discriminator.

Electrical Circuit

The circuit of a typical cathode-driven discriminator, given in Fig. 1, operates in the same fashion as the Foster-Seeley discriminator except for one important fact—the stage preceding the rectifier acts as a constant-voltage source (cathode follower) instead of a constant-current source (pentode amplifier). This in general means that the tube driving the discriminator may not

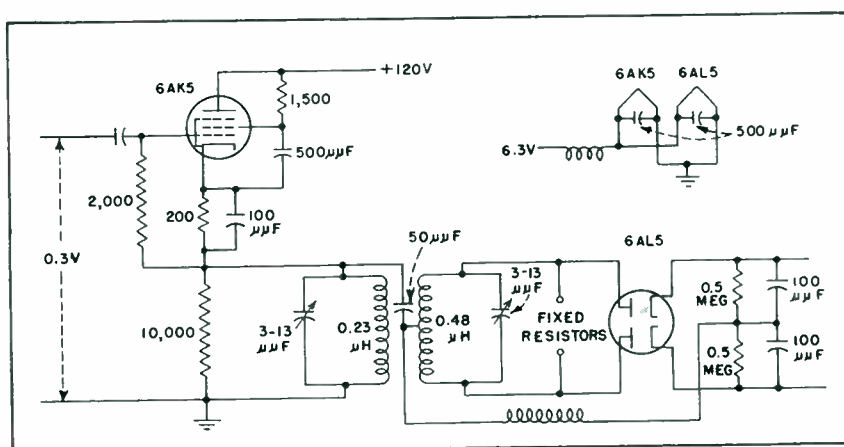

FIG. 1—Cathode-driven discriminator circuit, with values of components for center frequency of 60 mc

give good limiting action, so that the circuit may have to be preceded by a conventional limiter.

The coils forming the transformer in the cathode-driven discriminator may be coupled as tightly as possible, since the output of the discriminator is proportional to the coefficient of coupling between them and the bandwidth is independent of this coefficient. Circuit parameters given in Fig. 1 are for operation at a midfrequency of 60 mc, and all data given were taken about this midfrequency.

Theory of Operation

An analysis of the operation of a cathode-driven discriminator is partially given as an incidental part of a published analysis² of the Foster-Seeley discriminator, and the results of this analysis are of interest here. If the detectors are linear, the output voltage as a function of circuit parameters is

$$E_0 = \eta E_1 \left\{ \sqrt{\left[1 + \frac{\alpha Q_2 F}{2(1 + Q_2^2 F^2)} \right]^2 + \left[\frac{\alpha}{2(1 + Q_2^2 F^2)} \right]^2} - \sqrt{\left[1 - \frac{\alpha Q_2 F}{2(1 + Q_2^2 F^2)} \right]^2 + \left[\frac{\alpha}{2(1 + Q_2^2 F^2)} \right]^2} \right\} \quad (1)$$

where E_0 = d-c output voltage
 η = rectification efficiency of rectifiers

- E_1 = Peak r-f voltage across transformer primary
- $\alpha = Q_2 K \sqrt{L_2/L_1}$
- Q_2 = loaded Q of transformer secondary
- K = coefficient of coupling
- L_2 = inductance of transformer primary
- L_1 = inductance of transformer secondary
- $F = 2B/f_m$
- B = deviation
- f_m = midfrequency

Each radical in Eq. 1 represents the output of one of the two half-wave rectifiers. The expression may be simplified to

$$\frac{E_0}{\eta E_1} = \sqrt{1 + \alpha \frac{\frac{\alpha}{2} + Q_2 F}{1 + Q_2^2 F^2}} - \sqrt{1 + \alpha \frac{\frac{\alpha}{2} - Q_2 F}{1 + Q_2^2 F^2}} \quad (2)$$

Now if the detectors are square-law instead of linear, the effect on Eq. 2 is simply to remove each radical, leaving

$$\frac{E_0}{\eta E_1} = \frac{2\alpha Q_2 F}{1 + Q_2^2 F^2} \quad (3)$$

From this expression it is apparent that a plot of $E_0/\eta E_1 \alpha$ as a function of $Q_2 F$ or, since $F = 2B/f_m$, as a function of $Q_2 B$, should be independent of Q_2 . The effect of a change in Q_2 will be to produce a proportional change in the peak amplitude reached by E_0 since α depends di-

rectly on Q_2 , and to change Δv_p , the peak-to-peak bandwidth of the discriminator, inversely with Q_2 since the output will be a maximum for a given value of $Q_2 B$ independent of Q_2 . The curve given by Eq. 3 is identical with the voltage-frequency characteristic of microwave discriminators, and hence complementary to the frequency-voltage characteristic of a frequency-modulated microwave oscillator stabilized by such a discriminator³. As can be seen from a comparison of Eq. 2 and 3, the use of linear detectors instead of square-law makes the shape of the output-frequency characteristic somewhat dependent on the value of α , and hence on the Q of the tuned circuit. For small deviations (normalized with respect to peak deviation), or for coefficients of coupling less than unity, the difference between linear and square-law rectifiers is negligible.

Experimental Results

The results obtained from the circuit of Fig. 1 are shown graphically in Fig. 2 and 3. Figure 2 is a normalized plot of the output voltage-frequency characteristic of the cathode-driven discriminator for various loadings, in comparison with two curves taken at different loadings on a Foster-Seeley discriminator. The shape of the characteristic of the Foster-Seeley dis-

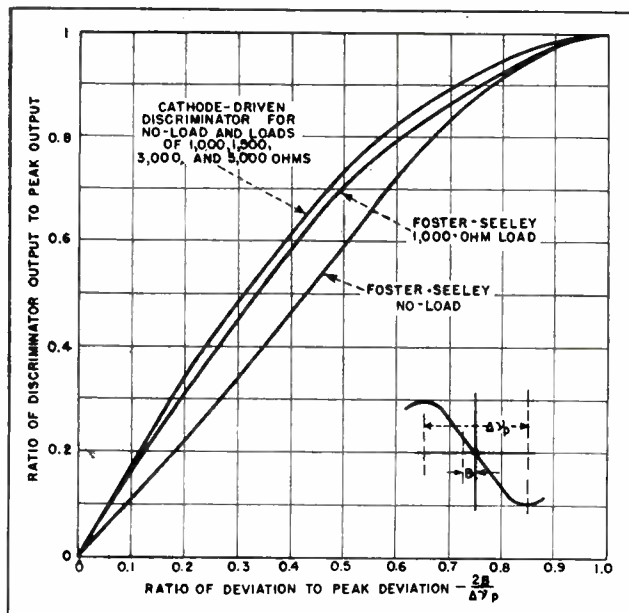
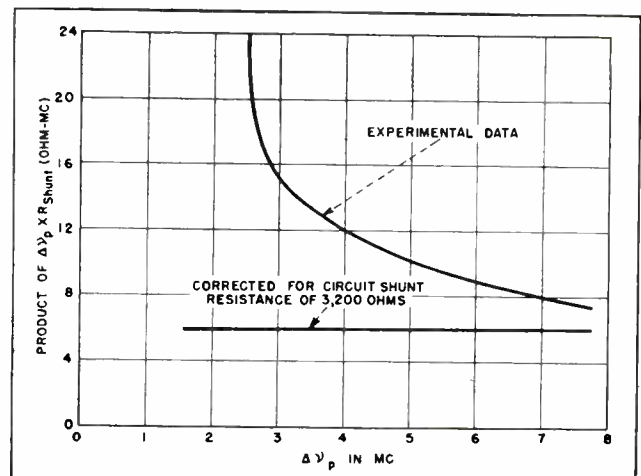

FIG. 2 (left)—Voltage-frequency characteristics of conventional and cathode-driven Foster-Seeley discriminators, showing that the cathode-driven discriminator is independent of loading

FIG. 3 (below)—Variation of bandwidth-load product with bandwidth for cathode-driven discriminator, showing how circuit losses provide lower limit to bandwidth obtained



criminator is a critical function of loading and coupling, optimum damping being somewhere between the no-load condition (circuit losses correspond to 3,200-ohm shunt resistor) and loaded condition (equivalent shunt resistance of 760 ohms) in the case studied. The normalized curves for the cathode-driven discriminator, however, are independent of loading within experimental error, as shown in Fig. 2.

Figure 3 is a plot of the product of the bandwidth and load resistance as a function of the bandwidth. (Table I is included for supplementary data not included in Fig. 3.) If the circuit Q were infinite, so that all losses were supplied by the loading resistor, this curve should be a straight line parallel to the abscissa since in this case $Q_s = \omega LR$. Therefore $R\Delta\nu_p$, where $\Delta\nu_p$ is peak-to-peak bandwidth, should be independent of R or $\Delta\nu_p$.

In practice, circuit losses provide a lower limit to the obtainable bandwidth. In the case investigated this came at 1.7 mc, equivalent to a shunting resistance of 3,200 ohms. This resistance was assumed to be included in parallel with the various load resistors.

The resistance of the parallel combination was computed for each case and a new curve plotted using the calculated resistance as the load. As is seen in Fig. 3, the resulting curve is within experimental error a straight line parallel to the abscissa. The load resistors used were measured at d-c rather than 60 mc, so that the a-c resistance of the highest-resistance units might be expected to be relatively lower than the a-c resistance of the lower units because of the Boella effect. This might explain the dropping off of the experimental points for small bandwidths.

Adjustment of the cathode-driven discriminator to give symmetrical curves was considerably easier than adjustment of the Foster-Seeley discriminator in all cases. This was especially true with respect to primary tuning in obtaining a symmetrical curve about f_m .

Distortion

Inasmuch as the cathode-driven discriminator is easy to adjust and not critical as to coupling coefficient,

FIG. 4 — Distortion curves for cathode-driven discriminator, giving amplitudes of important harmonic components as function of ratio of frequency deviation to peak-to-peak bandwidth of discriminator

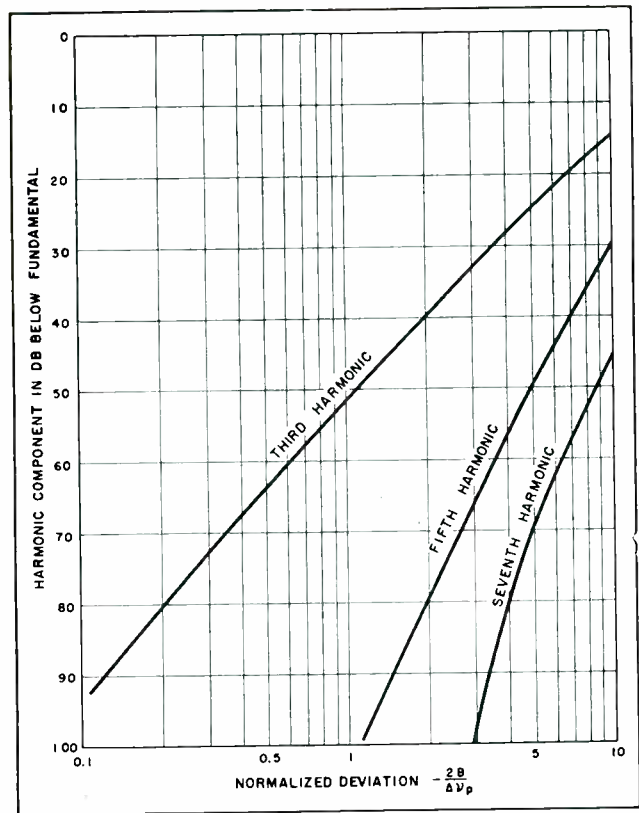

one might wish to use it in the detection of frequency-modulated signals from some linearly modulated source such as a broadcast station. In this application one is interested in the nonlinearity of the circuit, which will be somewhat greater than that of the Foster-Seeley discriminator.

Figure 4 shows the amplitude of the various important harmonic components in the output of the cathode-driven discriminator as a function of the ratio of deviation of incoming frequency to peak-to-peak bandwidth of the discriminator. These curves are an extension of the ones given previously in an analysis of microwave discriminators,³ the extension having been carried out

by twelve-point schedule analysis. As is shown by these curves, the peak-to-peak discriminator bandwidth must be five times the peak-to-peak deviation for 1 percent third harmonic distortion or 2.5 times the peak-to-peak deviation for 5 percent third harmonic distortion. These figures compare with the 1.7 ratio ordinarily used in commercial frequency-modulation receivers. The curves given apply for square-law detectors. If linear detectors are used, the ratio of 2.5 may be dropped to 2.1 for critical coupling. Distortion is always less with linear than with square-law rectifiers in this discriminator, but is somewhat dependent on coupling at high deviations.

This paper is based in whole or in part on the work done for the Office of Scientific Research and Development under Contract OEMsr-262 with the Massachusetts Institute of Technology.

REFERENCES

- (1) D. E. Foster and S. W. Seeley, Automatic Tuning, Simplified Circuits, and Design Practice, *Proc. IRE*, p 289, March 1937.
- (2) K. R. Sturley, The Phase Discriminator, *Wireless Engineer*, p 72-78, Feb. 1944.
- (3) W. G. Tuller, Distortion in F-M Discriminators, Technical Report No. 1, March 8, 1946, NDRC Division 14, Research Laboratory of Electronics, Massachusetts Institute of Technology.

TABLE I—Effect of Load Resistance on Bandwidth

Physical Load Resistor (ohms)	Actual Shunt Resistance* (ohms)	$\Delta\nu_p$ (mc)
∞	3,200	1.7
87,000	3,090	2.0
12,000	2,530	2.5
5,000	1,950	3.0
3,000	1,550	4.0
1,500	1,020	6.0
1,000	760	7.6

* Corrected for 3,200 ohms circuit resistance.

Analysis of Full-Wave

By D. L. WAIDELICH

Associate Professor
Department of Electrical Engineering
University of Missouri
Columbia, Missouri

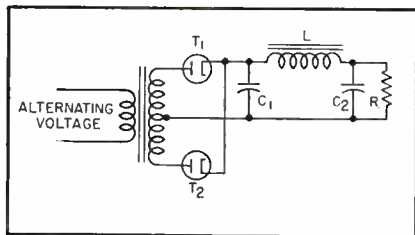

FIG. 1—Schematic circuit of the rectifier and filter

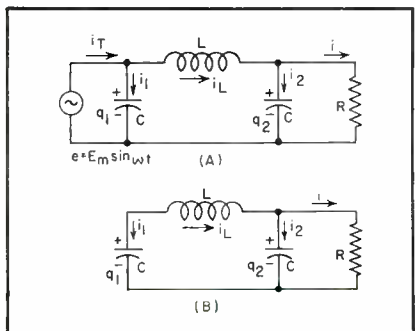

FIG. 2—Equivalent circuits of the rectifier and filter. (A) tube conducting; (B) tube not conducting

THE FULL-WAVE rectifier circuit with a capacitive-input filter is probably the most common of all rectifier circuits.

Freeman and Terman¹ have made an analysis of this circuit using as their chief assumption the idea that the filter inductance was infinitely large. They have presented curves which could be used in the design of the rectifier and filter circuit, but unfortunately the curves are valid only at lighter loads and at one frequency, that of sixty cycles per second. Stout² made an analysis which presented the waveforms in the circuit but gave no characteristic curves suitable for use in design, while Mitchell³ assumed an infinitely large inductance in his analysis.

This paper presents the results of an investigation made to determine the effects of a finite filter inductance on the operation of the rectifier and filter circuit. The results may be used in the design of the rectifier and filter circuit for any frequency and with any load from open circuit to short circuit.

The analysis of the circuit was made using the newly developed

steady-state operational calculus'. It was found that approximate values of the portion of a cycle that each tube was conducting would be helpful in the analysis, and these were obtained by setting up the circuit and observing the tube currents by means of a cathode-ray oscilloscope. With these approximate values as a starting point, the exact portion of each cycle that the tube was conducting could be determined from the analysis.

The schematic diagram of the rectifier and filter circuit is shown in Fig. 1. Tube T_1 conducts during the first half cycle of the applied alternating voltage and charges capacitor C_1 almost to the peak value of the alternating voltage.

Current flows from capacitor C_1 through the filter inductor L to charge capacitor C_2 . The load resistor R has the same voltage as the second capacitor C_2 . During the second half cycle of the alternating voltage, the second tube T_2 conducts, and capacitor C_1 is charged again to repeat the process. The filter may be thought of as a low-pass filter which passes direct current but greatly attenuates the alternating currents.

Assumptions

To make a mathematical analysis feasible, certain simplifying assumptions are necessary:

(1) The transformer and filter-inductor resistance is zero. The tube resistance is zero when it is conducting.

(2) The leakage reactance of the transformer is zero.

(3) Both filter capacitors have the same capacitance.

The errors caused by the first of these assumptions will be corrected for in a manner to be described.

Two equivalent circuits were

used as shown in Fig. 2. When the tube is conducting Fig. 2A applies, while Fig. 2B should be used when the tube is not conducting. The equations for the currents and voltages in the circuits were set up and then solved by the use of the steady-state operational calculus. The solution showed that the tube conduction angle γ of one tube depends only on the two independent variables $\omega^2 LC$ and ωCR where ω is 2π times the supply frequency, L is the inductance in henries of the filter inductor, C is the capacitance in farads of one filter capacitor, and R is the resistance in ohms of the load resistor. The variable $\omega^2 LC$ may also be regarded as the ratio of the reactance of the filter inductor to the reactance of one filter capacitor, while ωCR is the ratio of the load resistance to the reactance of one filter capacitor. The solution showed furthermore that all characteristics of this rectifier circuit depend on these two variables alone.

Filter resonance seems to occur at $\omega^2 LC = 0.5$, for then the sum of the reactances of the two filter capacitors and of the inductor is zero. This assumes that the reactances are calculated at the fundamental ripple frequency which is twice the supply frequency. The problems of practical importance at present always have $\omega^2 LC$ greater than 0.5 and for this reason it was decided to use 0.6 as the lowest value of $\omega^2 LC$.

Two special cases of the general solution were considered separately because of the significance of the results. The first of these is that for $\omega^2 LC$ infinitely large which implies that the filter inductance is infinitely large and that the current through the inductor has zero ripple.

Rectifier and Capacitive-Input Filter

Some simplifying assumptions make it possible to express results in terms of two general parameters. Data are presented for tube angles, output voltage, ripple, and peak tube currents. Filter resonance, pulsed current, and continuous current operation are included

The other special case might be called the non-cutoff or the continuous-current case in that each tube is conducting 180 degrees and the current entering the filter never cuts off or drops to zero. The current in each tube is stopped by conduction starting in the other tube, and a form of commutation between the tubes is set up in which the current switches from one tube to the other and back again.

The main problem for this second special case is not that of finding γ which is known to be 180 degrees, but that of finding the boundary or dividing line between the cut-off or pulse-current and non-cut-off or continuous-current cases. In the analysis it was found that the boundary occurred at approximately $\omega CR = 0.6$ with the continuous-current case occurring for smaller values of ωCR and the pulsed-current case for larger values of ωCR .

Characteristics

The characteristics of the circuit that are of the most use in the design of the circuit and predetermining its properties are the tube angles, the average output voltage, the ripple, the peak and average tube currents, and the peak inverse voltage on the tubes.

The angle γ during which the tube conducts is presented in Fig. 3 as a function of $\omega^2 LC$ for various values of ωCR . For a fixed value of $\omega^2 LC$ this angle varies from zero degrees at open circuit (ωCR infinitely large) to 180 degrees for the continuous-current case which includes values of ωCR from approximately 0.6 to zero (short circuit). With ωCR fixed, the angle

γ varies little for values of $\omega^2 LC$ above ten, but for $\omega^2 LC$ less than ten the variation is considerable, especially as filter resonance is approached ($\omega^2 LC = 0.5$).

The angle β at which the tube stops conducting is presented in Fig. 4 and the manner of variation is similar to that for angle γ . For a fixed value of $\omega^2 LC$, angle β varies from ninety degrees at open-circuit to 180 degrees for values of ωCR from approximately 0.6 to zero (short circuit). The angle α at which the tube starts conducting may be found by the use of the relation, $\alpha = \beta - \gamma$. Increasing the load of the rectifier circuit has the effect of increasing both angles β and γ , while α is decreased. The effect of approaching resonance in the filter is similar in that angles β and γ are increased, while α is decreased.

One of the most important characteristics of a rectifier circuit is the average output voltage. This voltage may be obtained from the ratio of the average output voltage to the maximum value of the sinusoidal voltage across one-half of the transformer secondary, E_{ac}/E_m . The ratio E_{ac}/E_m is given in Fig. 5 as a function of $\omega^2 LC$ for various values of ωCR . For a fixed value of $\omega^2 LC$, the ratio decreased from a maximum of unity for ωCR infinitely large (open circuit) to 0.637 for ωCR equal approximately to 0.6. For values of ωCR from 0.6 to zero (short circuit) the continuous-current case applies, and $E_{ac}/E_m = 0.637$. The voltage ratio E_{ac}/E_m varies little for large values of $\omega^2 LC$, but changes considerably as $\omega^2 LC$ approaches the resonance

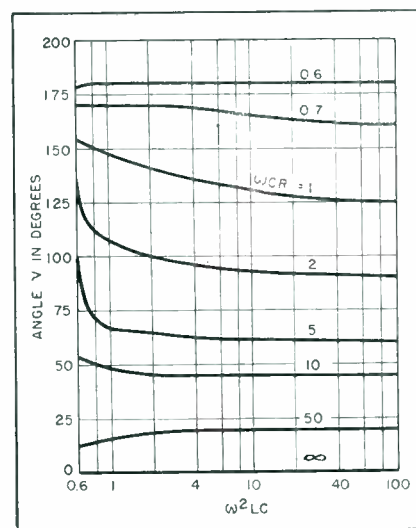

FIG. 3—Angle during which the tube conducts

value of 0.5. Both increasing the load and approaching filter resonance have a similar effect, that of making the voltage ratio approach 0.637.

The ripple voltage across the load resistor of the rectifier circuit is another important characteristic. It may be obtained from the percent ripple r which is defined as 100 times the ratio of the effective value of the fundamental ripple voltage appearing across the load resistor to the average voltage E_{ac} across the same resistor. In practice only the fundamental ripple voltage is sufficiently large to warrant consideration, and for a full-wave circuit, the fundamental ripple frequency is twice the supply frequency.

For large values of $\omega^2 LC$ and ωCR it was found possible to give a partly empirical and partly theoretical expression for the percent

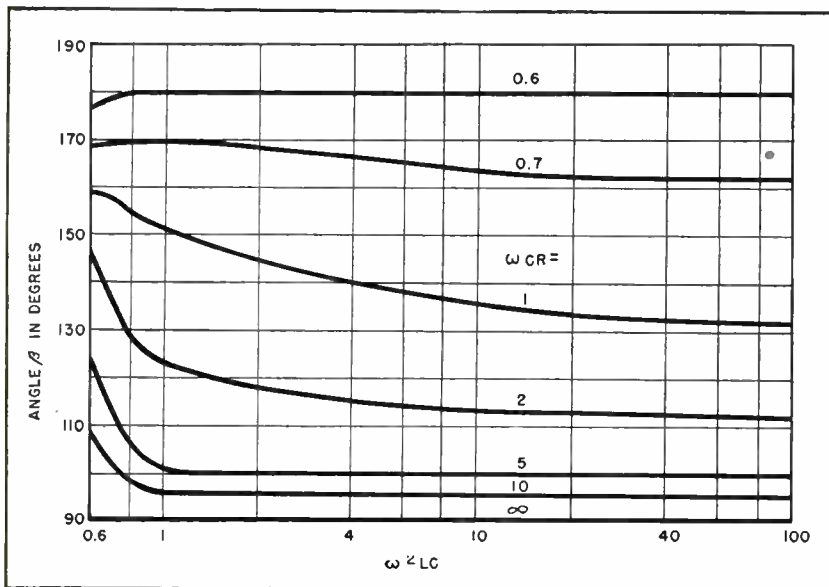

FIG. 4—Angle at which the tube stops conducting

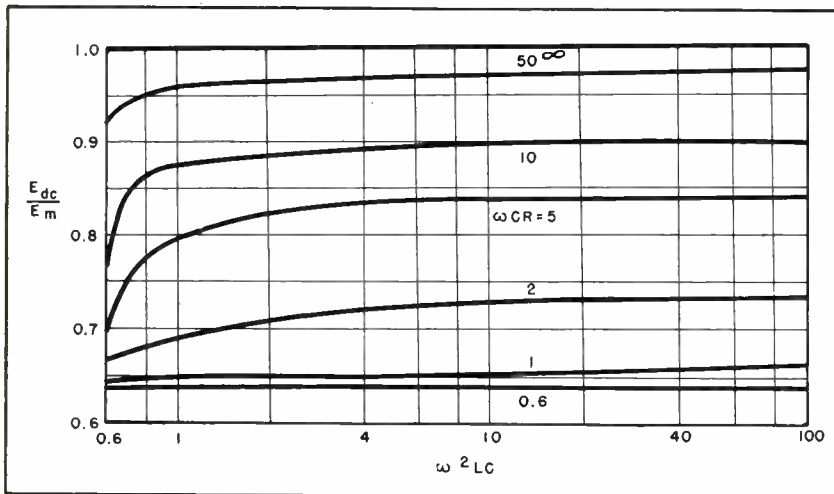

FIG. 5—Average output voltage

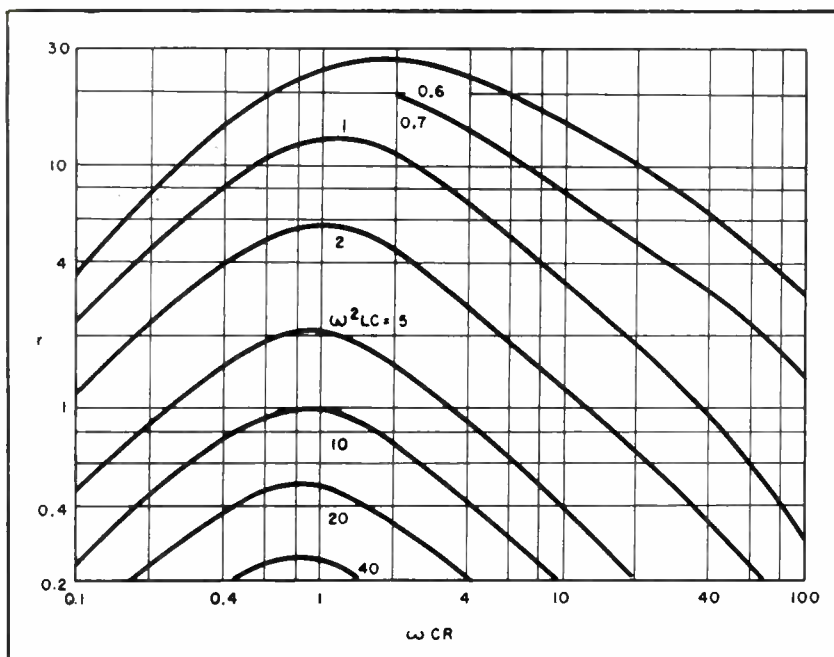

FIG. 6—Percent of ripple voltage

ripple across the load resistor. This is

$$r = \frac{31.5 + 67.25 \omega^2 LC}{(\omega^2 LC) \sqrt{4 (\omega^2 LC)^2 + (\omega CR)^2 (4 \omega^2 LC - 1)^2}} \quad (1)$$

and the error in the percent ripple will be less than five percent if $\omega^2 LC \geq 2.0$ and $\omega CR \geq 5.0$.

Equation 1 will be applicable in many of the problems encountered in practice, particularly those in which the circuit is lightly loaded. It expresses the percent ripple for the region where each tube is firing only a short time, the output voltage is high, and the charges on the filter capacitors do not vary much during one cycle.

For heavier loads, the percent ripple is shown as curves in Fig. 6. For $\omega^2 LC$ constant, the ripple increases from zero for ωCR approaching infinity (open circuit) to a maximum in the vicinity of ωCR equal to unity and then approaches zero again as ωCR approaches zero (short circuit). For a fixed value of ωCR , the percent ripple increases from zero for $\omega^2 LC$ approaching infinity (infinitely large inductance) toward a maximum as $\omega^2 LC$ approaches 0.5 (filter resonance). For very heavy loads ($\omega CR < 0.6$) the continuous-current case applies and the percent ripple r is given by

$$r = \frac{47.14 (\omega CR)}{\sqrt{4 (\omega^2 LC)^2 + (\omega CR)^2 (4 \omega^2 LC - 1)^2}} \quad (2)$$

The percent ripple approaches zero as ωCR approaches zero (short circuit) because most of the ripple voltage appears across the inductor and very little of it appears across the output load resistor, while all of the average voltage appears across the load resistor.

The peak tube current may be obtained from the ratio P_r of the peak tube current to the average current for one tube. An empirical equation was fitted to the calculated values of P_r and this equation is

$$P_r = 5.016 (\omega CR)^{0.5025} \quad (3)$$

where $\omega CR \geq 0.6$. For values of ωCR from 0.6 to zero, P_r varies from four to a minimum of two.

The inverse peak voltage applied to each tube is always the maximum value of the transformer secondary voltage.

The circuit was set up to obtain experimental verification of the foregoing calculated results. Measurements were made with a sixty-cycle source of alternating voltage and with a filter having $\omega^2LC = 2.0$. This value of ω^2LC was chosen so that a large range of ωCR could be obtained. Filters with other values of ω^2LC were also used with good agreement.

Experimental Results

Various quantities such as average output voltage, ripple voltage, and the tube angle γ were measured. Figure 7 shows the calculated and experimental results for the average output voltage ratio with the calculated results shown as a solid curve and the experimental points as circles. Agreement is good except for low values of ωCR which correspond to heavy loads.

For heavy loads the resistance of the rectifier tube, transformer, and filter choke become appreciable in comparison to the load resistance. These resistances were measured and were added to the load resistance to give an equivalent load resistance. The tube resistance was taken as the voltage across the tube at rated current divided by the rated load current of the tube. The average output voltage is then the product of the average output current and the equivalent load resistance.

The new value of ωCR is increased since the equivalent load resistance is larger than the load resistance alone. The resulting compensated experimental values are shown as crosses in Fig. 7, and the agreement between the experimental points and calculated curve is quite good even for heavy loads (small values of ωCR).

Similar results for the percent ripple are shown in Fig. 8. Since the percent ripple is inversely proportional to the average output voltage, the compensated values of percent ripple are smaller than the uncompensated ones. Again agreement between the calculated curve and the compensated experimental points is good.

The peak tube currents will be somewhat in error for high values of ωCR even though compensation is used. Equation 3 will give some-

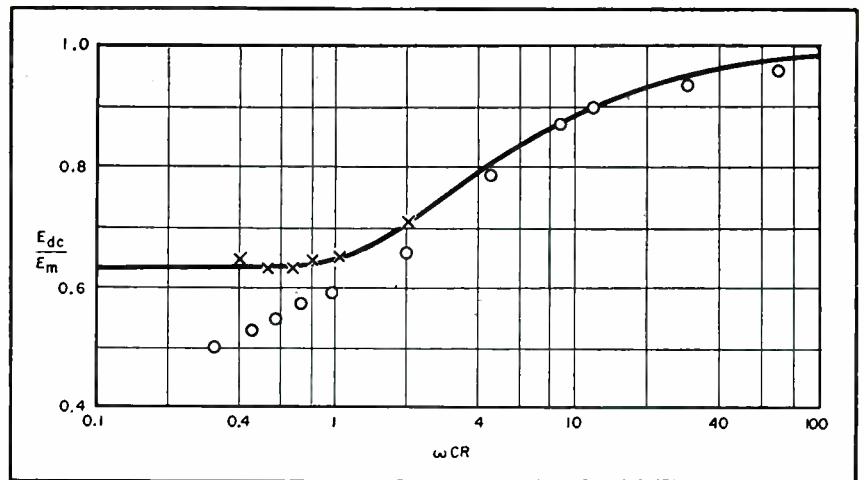

FIG. 7—Average output voltage for $\omega^2LC = 2.0$. The solid curve is calculated, the circles are uncompensated experimental points, and the crosses are compensated experimental points

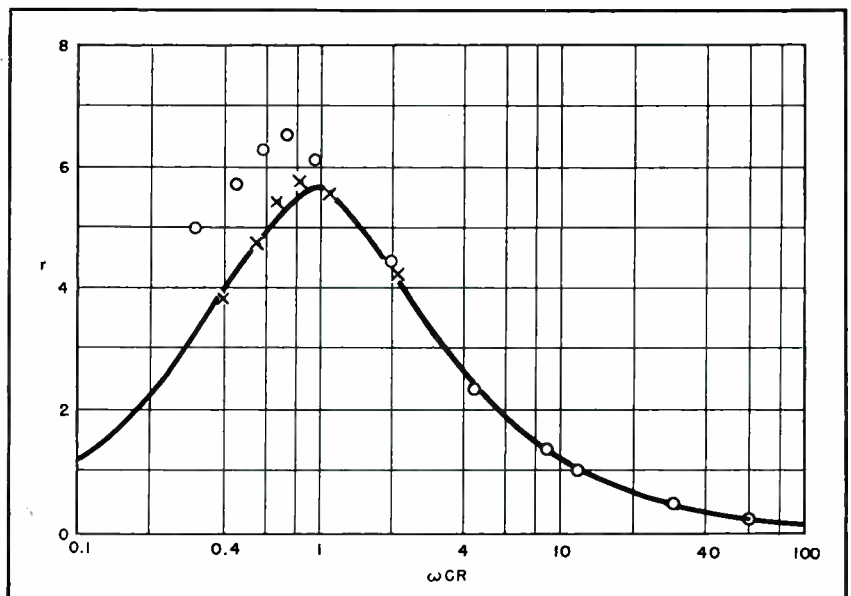

FIG. 8—Percent ripple voltage for $\omega^2LC = 2.0$. The other conditions are the same as illustrated in the graph of Fig. 7

what high values of peak currents in this case.

One very common design problem is that in which the maximum ripple, the load current and voltage, and input alternating voltage and frequency are known and the filter components, tube and transformer are to be selected. If a size of filter capacitor is selected, ωCR may be calculated. From the ripple characteristics of Fig. 6 the value of ω^2LC may then be selected to give the maximum permissible ripple. The inductance necessary may then be obtained from ω^2LC . If an inductance of this size is not available, a different value of capacitance C should be selected and the whole procedure repeated.

Once the values of ωCR and ω^2LC have been obtained the secondary voltage of the transformer may be found from the average voltage characteristics of Fig. 5. The tube or tubes may be selected by the use of Eq. 3. If the tube, transformer, and choke resistances are appreciable, they should be taken into account.

REFERENCES

- (1) F. E. Terman, "Radio Engineer's Handbook", First Edition, McGraw-Hill Book Co., Inc., 1943, p 602-605.
- (2) M. B. Stout, Analysis of Rectifier Filter Circuits, *Trans. A.I.E.E.*, 54, p 977, Sept. 1935.
- (3) R. G. Mitchell, Vacuum Rectifiers Working with Condenser Input, *Wireless Engineer*, 20, p 414, Sept. 1943.
- (4) D. L. Waidelich, The Steady-State Operational Calculus, *Proc. I. R. E.*, 34, p 78, Feb. 1946.

Current in auxiliary winding on saturable core reactor controls current in main winding. High amplification and fast response are obtained. These magnetic amplifiers have been used in gun control servomechanisms, braking systems of electrical locomotives, and in automatic aircraft pilots. Research has been conducted toward their use in the steering control of V-2 rockets

By **WALTER E. GREENE**

*Lt. Comdr. USN
Electronics Officer
Office of Naval Research
Washington, D. C.*

Magnetic amplifiers, essentially saturable core reactors in which the degree of magnetization and flux change is controlled by auxiliary windings, were invented by E. F. W. Alexanderson for use with his alternator. However they had not been widely applied because of limitations of core materials and lack of a high-current rectifier. High permeability core materials have been alloyed in Japan, efficient selenium rectifiers have been developed in Germany and the theoretical analysis in Scandinavia so that this American device is now practical. The nonelectronic amplifier, being free from mechanical limitations of vacuum tubes, may well provide the means for wider industrial application of the techniques built around electronic amplifiers. Development of magnetic amplifiers dramatizes the international aspects and interrelations of basic sciences of modern technology, and also reminds us occasionally to review discarded techniques in the light of current materials to determine whether their shortcomings have been negated by subsequent developments.—Editors.

Applications of MAGNETIC

INTERROGATION of German prisoners revealed that the German Navy had begun replacing some electronic servoamplifiers, which were part of their naval fire control equipment, with servoamplifiers that employed magnetic amplifiers not liable to damage by shock or vibration. Although antedating vacuum-tube amplifiers, magnetic amplifiers had been little used in America. This information of German use indicated however that these devices could compete with vacuum tubes in some applications, just as other nonlinear devices have

been used in place of vacuum tubes for modulation and detection.

The magnetic amplifier was first disclosed in a United States Patent granted to E. F. W. Alexanderson of the General Electric Co. in 1916. Over a period of years this patent was followed by 75 to 80 others. The purpose of Dr. Alexanderson's development was to provide means for modulating high-frequency alternating currents from one of his alternators so that its current could be used for trans-Atlantic radio telephony. It is interesting to note that by 1916 the magnetic amplifier

had been used to modulate as much as 72 kw while Dr. DeForest's three element vacuum tube had been developed to handle only a few watts.

The magnetic amplifier became of minor domestic importance because of growing popularity and technical advances in vacuum-tube techniques. Development of high-permeability magnetic core materials, and efficient dry disk rectifiers, both necessary to the development of magnetic amplifiers of high efficiency, came later. By the time these components were available, the magnetic amplifier had been for-

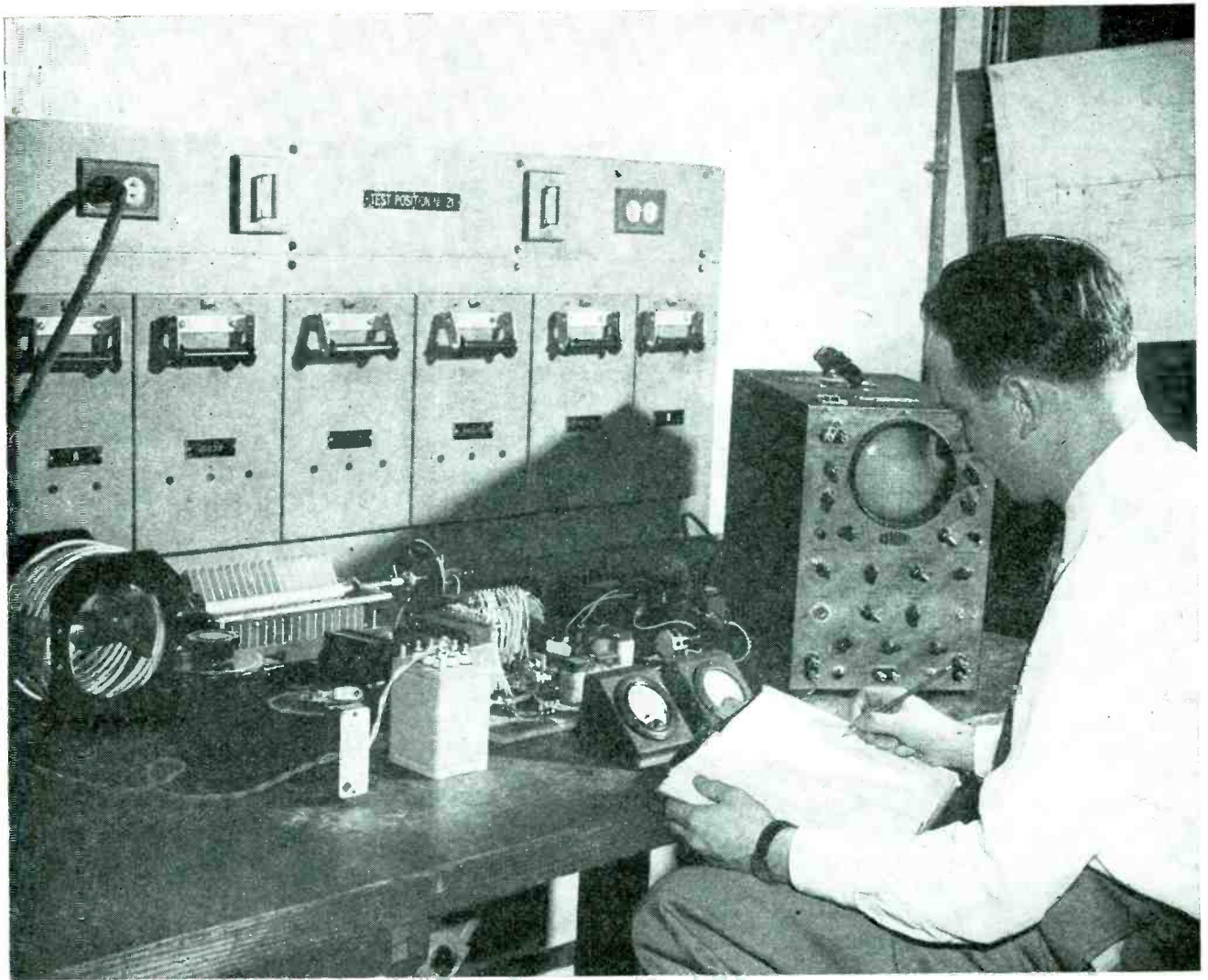

Measurements on modern magnetic amplifiers show that they have fast response and high gain

AMPLIFIERS

gotten and "amplifier" became synonymous with "vacuum tube amplifier". However, European scientists pursued its development for power applications.

With the ascendancy of the Nazi regime in Germany, scientific research became highly important for development of their war machine. The Germans investigated everything that could be of military use, including the magnetic amplifier. American engineers had failed to parallel development of the related components with improvements in the magnetic amplifier.

The Germans, however, took the magnetic amplifier, added a more recent noteworthy U. S. development, Permalloy, a magnetic material having high-permeability characteristics, and also took advantage of the dry disk rectifier (copper oxide, copper sulfide, and especially selenium). The excellence of the German selenium rectifier was a great aid in their development of the magnetic amplifier.

Though Germany has been quite successful in the development of this device for military use, greater success was inhibited by lack of

proper coordination between their Army, Navy, and Air Force. Each service conducted its individual program, disseminating a minimum of information to other services.

The German Navy employed magnetic amplifiers wherever possible on their naval vessels, some having been installed a decade before the war; they operated satisfactorily and without attention for the life of the vessel. They were used for stabilizing range finder mounts, gun mounts, and as preamplifiers to servosystems used to stabilize anti-aircraft directors in space. The

Germans were also developing all-electric computers in which magnetic amplifiers were used in a manner analogous to the way we employ cathode follower vacuum tube circuits.

As a control device, the Luftwaffe used it in connection with automatic pilots. The German Army also conducted extensive research at Peenemunde in applying the magnetic amplifier to the V-2 as a steering control. It was also developed as a frequency regulator for motor-generator sets capable of maintaining accuracy to within 1/1,000 of the desired frequency while using a d-c motor whose voltage supply was not constant. Commercial use appears to have begun about 1942 or 1943 with application to electrical braking systems for railroad locomotives. At Darmstadt, research had begun in applying the magnetic amplifier to high-voltage power lines; however, this was interrupted by allied bombings and never developed past the fundamental research stage.

The Japanese conducted fundamental research on magnetic amplifiers but did not develop them to any great extent. Fire control equipment, purchased from the Germans, included magnetic amplifiers, but it never reached Japan because of the allied shipping blockade. The Japanese, however, developed magnetic core materials, which in the future will play an extremely important role in magnetic amplifier progress.

Other Foreign Contributions

Although Japan has never been an outstanding nation in the development of electronic equipment, there is one important exception, namely, in the field of magnetism: in this Japan led the world. In most countries, research in magnetism has always been a somewhat secondary consideration in electronic development. This was not true, however, in Japan. For over 30 years there has been maintained at Sendai, a government sponsored Research Institute for Iron and Steel and Other Metals, under Tohoku Imperial University. As a result of the work of this and other magnetic laboratories, Japan is responsible for at least half of the

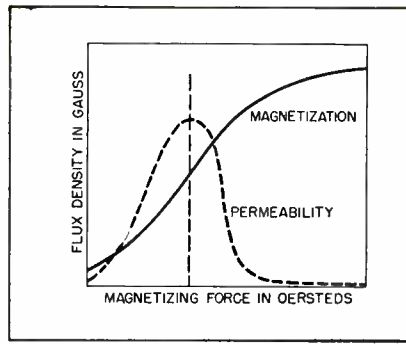

FIG. 1—Typical magnetic characteristics

new magnetic materials introduced since 1920. The most important of these are Alfer, Sendust, and special silicon-iron alloys having permeabilities nearly twice that of United States' best magnetic material. These are vital to efficient magnetic amplifier design, for it is the property of extremely high permeability at low values of magnetomotive force that allows the magnetic amplifier to achieve high amplification. Of equal, if not greater importance is the fact that these alloys contain no nickel, an element in which Japan, Germany, and the United States are strategically deficient.

Swedish engineers are also interested in the magnetic amplifier. Dr. Uno Lamm, wrote a book in 1943 on the subject of magnetic amplifiers entitled "The Transductor." This work gives perhaps the most complete technical and theoretical treatise on the magnetic amplifier which has been published to date. The book discusses use of the magnetic amplifier for automatic regulating and relaying purposes.

The British are also conducting research on the magnetic amplifier. Reports show that they have been able to overcome to a certain extent a major fault of this device—the slowness of response to control signals.

Basis of Operation

Before discussing some of the mechanics of the saturable core reactor and the complete magnetic amplifier, it is advisable to review briefly the properties of iron-cored coil.

Any coil possesses the property of electrical inertia, called inductance. This inductance opposes a change in the current in the coil. The magnitude of this property is

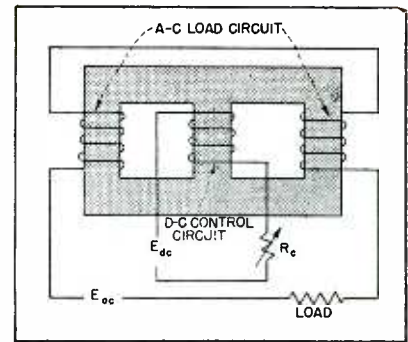

FIG. 2—Simplest amplifier connection

expressed in units called henrys. In an iron-cored coil, the inductance is dependent to a very great extent on the permeability of the iron in the core. Permeability is, in effect, a measure of the relative ease with which magnetism flows in a certain circuit.

The relationship between inductance and the permeability of the core is

$$L = \frac{1.256 N^2 \mu a_c}{l_c} \times 10^{-8} \text{ (henrys)}$$

where N is number of turns in the coil, μ is permeability, a_c is cross sectional area of the core in centimeters, and l_c is length of the magnetic path in centimeters. These constants are those used in the cgs system.

Because the permeability is not a constant, the inductance will vary with it. Therefore one must consider the permeability next.

Permeability of magnetic material is defined as the ratio B/H , where B is flux density (lines per square centimeter in the cgs system) and H is the magnetizing force (in oersteds, or in ampere turns since one ampere turn per centimeter is 1.256 oersteds). With these units, the permeability of air is unity.

Permeability, depending on flux density, is in general, small at low flux densities, maximum at moderate values and quite small when the core is saturated, as shown in Fig. 1.

A circuit containing inductance will, when subjected to an alternating voltage, have a current whose value is determined by $I_{ac} = E_{ac}/X_L$ where X_L is inductive reactance, which in turn is related to the inductance of the circuit by $X_L = 2\pi fL$ where f is frequency of the alternating voltage. So, as X_L increases, I_{ac} decreases and vice versa.

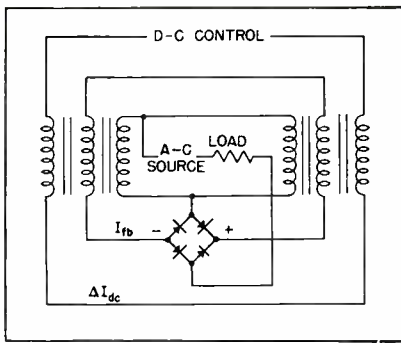

FIG. 3—Self-excitation can be used

For the purposes of this discussion, saturable core reactors are considered to be the actual transformer-like structures that are part of the complete magnetic amplifier circuit. A saturable core reactor consists of separate load and control windings with, perhaps in specialized cases, additional windings for feedback and stabilization circuits. Uses of these windings will be developed in the following discussion.

Because a given amount of direct current will control a larger amount of alternating current, the device is an amplifier and for many purposes can be considered analogous to a vacuum tube. A reactor used in this manner, together with selenium or dry rectifiers to provide the direct current, is called a transductor in Sweden.

Figure 2 shows a simplified circuit of a typical saturable core reactor. The reactor is designed so that with little or no current flowing in the d-c control winding, the reactance of the load windings is high and effectively limits the a-c to a small value. With a relatively large d-c flowing, the core becomes saturated, the permeability decreases, inductance and consequently reactance decreases and the a-c increases, allowing more a-c power to be dissipated in the load.

The amplification factor or more specifically in this case—the control ratio, can be defined as the ratio of ampere turns in the load windings to ampere turns in the control winding.

$$R_{\text{control ratio}} = \frac{NI_{\text{load}}}{NI_{\text{control}}}$$

Where NI_{load} is the number of turns of wire in the load windings multiplied by the current flowing through them; the same is true for NI_{control} .

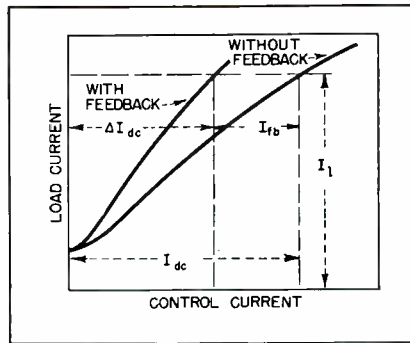

FIG. 4—Feedback increases sensitivity

Dr. D. W. Ver Planck of Carnegie Institute of Technology, working under sponsorship of the Office of Naval Research, has found that certain core and winding configurations have advantages over others as far as control ratio, speed of response, and insulation requirements are concerned.

The two reactors mentioned so far have been series wound. Of course it is possible and often desirable to use parallel wound reactors. It is known that as far as steady state performance is concerned, the series and parallel connections are of equal merit provided the impedance of the load is relatively small, as is usually the case.

Using Feedback

A German scientist, Dr. Theodor Buchhold, doing basic research on saturable core reactors and their applications in magnetic amplifiers, has demonstrated that addition of a certain amount of feedback current in the amplifier circuit reduces the necessary control power. A typical circuit utilizing feedback is as shown in Fig. 3; each reactor has primary, secondary, and tertiary windings.

Action of the feedback current can be shown with reference to the curves of Fig. 4. The one curve shows variation of load current as a function of the control current in a saturable reactor circuit such as that of Fig. 2. If a particular amount of feedback is added by a circuit such as that of Fig. 3, the load current varies more for a given change in control current than without feedback, as shown by the other curve. The reactor still requires the same total direct-current control as without feedback, however a large portion of the control current is supplied by the feed-

back winding; the control circuit need supply only ΔI_{dc} . Unless precautions are taken in feedback design, there is danger of instability of the system with resultant large currents.

Figure 5 shows a circuit used for frequency regulation of motor-generators by means of feedback through a magnetic amplifier. Normally changes in the d-c supply to the motor would cause changes in the speed and hence the frequency of the alternator. With the control circuit, however, if the frequency of the alternator changes from the intended value of 400 cps, increased current will flow through one or the other resonant circuit producing more current in one of the control windings of the saturable core reactor. In the case of falling frequency of the alternator, more current will flow through L_4 . The magnetism so caused opposes that produced by the rectified alternator current that flows in L_6 and is also used to excite the motor. The decreased magnetism resulting from this opposition results in increased reactance of L_6 , so that the current in the motor field is reduced, the motor accelerates, and the alternator frequency is restored to normal, with both resonant circuits drawing equal currents. By this system the alternator frequency can be controlled to one part in 1,000.

Speed of Response

In all of the presently known magnetic amplifier circuits there is one common fault: the slowness of response to control, which is inherent in any circuit containing a large amount of inductance. In most commercial applications this sluggishness of response is not an important drawback, but in certain military and commercial applications which are foreseen, a very short response time is necessary.

In preliminary laboratory work in this country a response time of approximately 6 cycles of the 60 cycle a-c supply has been obtained. The German naval magnetic amplifiers on the other hand had a response time of over 16 cycles of the supply frequency, which was, however, 333 cycles per second. The actual power gain of these German units was rather low, about 100. It

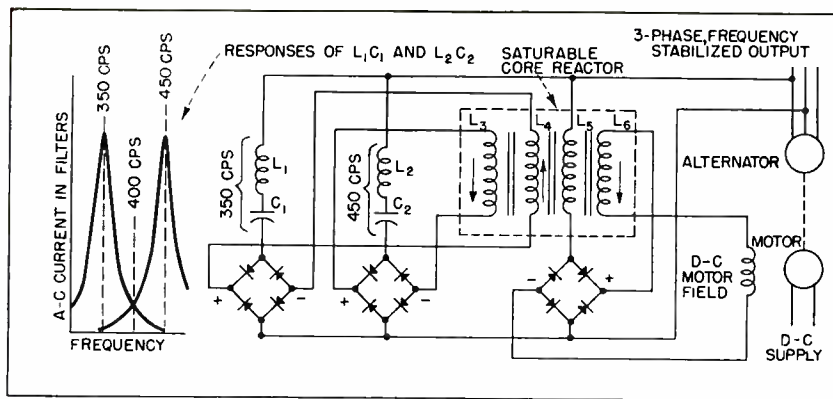

FIG. 5—Magnetic amplifier stabilizes frequency of alternator

would be desirable for naval applications, to have a response time of 1 cycle or less at 60 cycles supply frequency.

An obvious way to circumvent this problem and reduce the response time would be to increase the supply frequency. In Alexander's work, where he was using a supply in the neighborhood of 25 to 30 kc, response time was not a problem and his amplifier (or modulator in his case) was able to follow variations in audio-frequency control currents.

Changing the supply frequency of large power installations to any great extent seems to be impractical at this time. Therefore, it is important to approach the problem from the standpoint of the magnetic amplifier itself. The British have achieved some success in the solution of the response time problem by using a feedback or phase advance circuit, the nomenclature depending on one's point of view.

Future Potentialities

In conclusion it may be said that the magnetic amplifier has been up to now a relatively forgotten American invention which was taken by German engineers and given the prominence necessary to assure its proper development and application. Successful use of the magnetic amplifier throughout the German Navy for ten years has demonstrated beyond doubt its efficiency and practicability in use where equipment is subject to shock or vibration. As a matter of fact, this ruggedness was demonstrated by an instance when a mine, utilizing a magnetic amplifier, was dropped from a considerable height by an aircraft. It struck the ground in-

stead of the water, was practically demolished, and scattered over the terrain. The magnetic amplifier portion, however, when recovered and tested, functioned normally.

Unlike the vacuum tube whose impedance is ohmic and therefore introduces considerable internal power loss, the impedance of the magnetic amplifier is an inductive reactance, which dissipates but little energy as heat, giving back most of it to the circuit, like any other inductance. It can be made in any size depending upon its application and can be extremely sensitive. Magnetic amplifiers have been made which gave a power gain of 100,000. There is no limit to the kilovolt-ampere capacity, except size, which makes it ideal for controlling high power. Designs in Germany ranged up to 50,000 kva.

The magnetic amplifier will undoubtedly have extensive use, not only in the electrical control of military and naval equipment but especially in commerce. For control of many manufacturing processes and automatic devices for private use, it cannot be surpassed. It would be excellent if developed for underground and transoceanic cable use for, containing no moving parts and not requiring servicing, it can be installed in such a cable system and forgotten.

The magnetic amplifier is, at the present time, far from being a perfectly developed device. Its two major faults are that it has an inherently slow response time, and it is an efficient amplifier only if it has a core material of extremely high permeability. The latter of these two deficiencies can be improved with the development of core material made of noncritical materials

which are sufficiently cheap so that magnetic amplifiers can be used as expendable devices.

Germany has returned to us a much improved magnetic amplifier together with an excellent selenium rectifier; Japan has provided vitally important basic research on efficient nonstrategic core materials. The magnetic amplifier today is at a developmental stage comparable to that of the vacuum tube 20 years ago. Its future capabilities are limited only by the degree of attention it receives from research agencies in this country. The Office of Naval Research, realizing the potentialities of this device, is coordinating a concerted program of fundamental and applied research on the magnetic amplifier and its applications in coordination with the Bureau of Ships, the Bureau of Aeronautics, the Bureau of Ordnance, and the Army. The improvement and utilization of this device may well prove to be a most important technical development.

Since this paper was written, Dr. Uno Lamm has visited the United States and lectured under sponsorship of the United States Navy on the theory and applications of the magnetic amplifier. He brought several pieces of demonstration apparatus with him and it was learned that Sweden is probably farther ahead in the techniques of utilizing the magnetic amplifier for power control and measurement than any other country at this time.

BIBLIOGRAPHY*

- (1) A. Uno Lamm, Some fundamentals of a theory of the transductor or magnetic amplifier, paper presented at A.I.E.E. meeting, Montreal, Canada, June 1947, to be published by A.I.E.E. Combination of presaturated reactor and metallic rectifier gives a control action very similar to that of grid controlled rectifier; proper design leads to fast response; analysis is on basis of voltage absorption and flux deviation rather than variation of permeability.
 - (2) Reactance amplifiers, *ELECTRONICS*, p 28 Oct. 1937. Investigations of possible industrial applications of saturated reactors conducted by A. S. Fitzgerald at Haverford College are described.
 - (3) Eduard Karplus, Components of uhf field meters, *ELECTRONICS*, p 124 Nov. 1946. Among the components described is a power supply stabilizer using a controlled saturable reactor.
 - (4) L. R. Wrathall, Frequency-modulation by nonlinear coils, *Bell Laboratories Record*, p 102 March 1946; abstracted in *ELECTRONICS*, p 208 May 1946. Both carrier and signal are fed to reactor; pulses generated as flux of reactor passes through zero are filtered to give frequency-modulated output.
- *Although definitely not as widely known or applied domestically as electronic tubes, magnetic elements have, as this bibliography indicates, been used in various ways. If readers know of other literature in which controlled reactors are described, we would appreciate their calling it to our attention. THE EDITORS.

Cinch Sockets ARE STANDARD

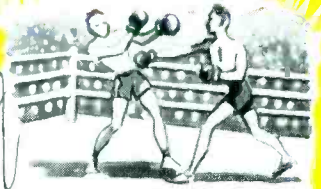

CINCH DUODECAL

for TELEVISION



CINCH DUODECAL SOCKET—No larger in diameter than the tube base and only slightly longer than the tube pin. New feature incorporates wire strain relief as an integral part of the contact.

CINCH DIHEPTAL SOCKET—Full floating contacts designed to insure easy insertion of tube and yet provide excellent electrical connections. Quick to wire. Mounting ring permits easy orientation of tube. Available in two sizes.

CINCH MAGNAL SOCKET—An eleven prong socket, which possesses same features as the diheptal.

CINCH STANDARD SOCKETS are being used in television sets with both ceramic and low-loss bakelite insulators to meet every requirement.

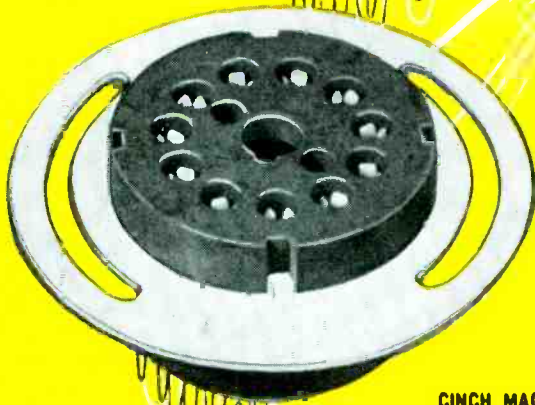

CINCH MAGNAL 9452

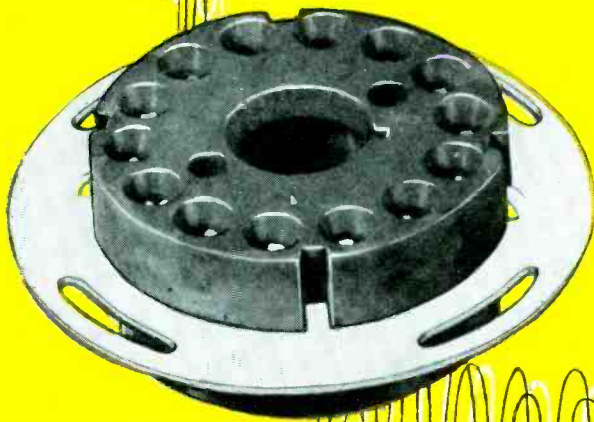

CINCH DIHEPTAL 9450

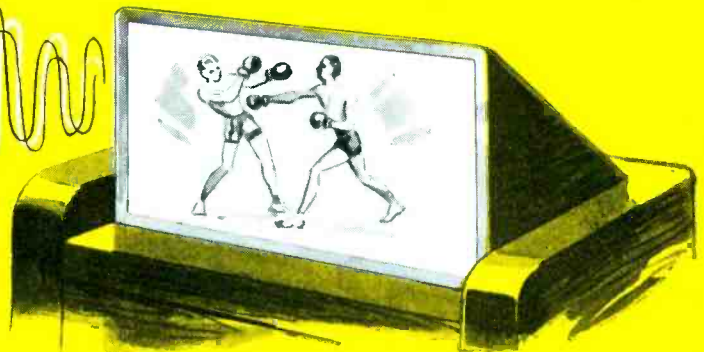

Cinch MANUFACTURING CORPORATION
2335 WEST VAN BUREN STREET • CHICAGO 12, ILLINOIS

Subsidiary of UNITED-CARR FASTENER CORPORATION, Cambridge 45, Mass.

Magnetostriction Resonant Frequencies

Nomograph for ultrasonic and sonic applications gives natural vibrating frequency of oscillator when rod length and magnetostrictive material are known

By **R. C. COILE**

*Colton & Foss, Inc.
Washington, D. C.*

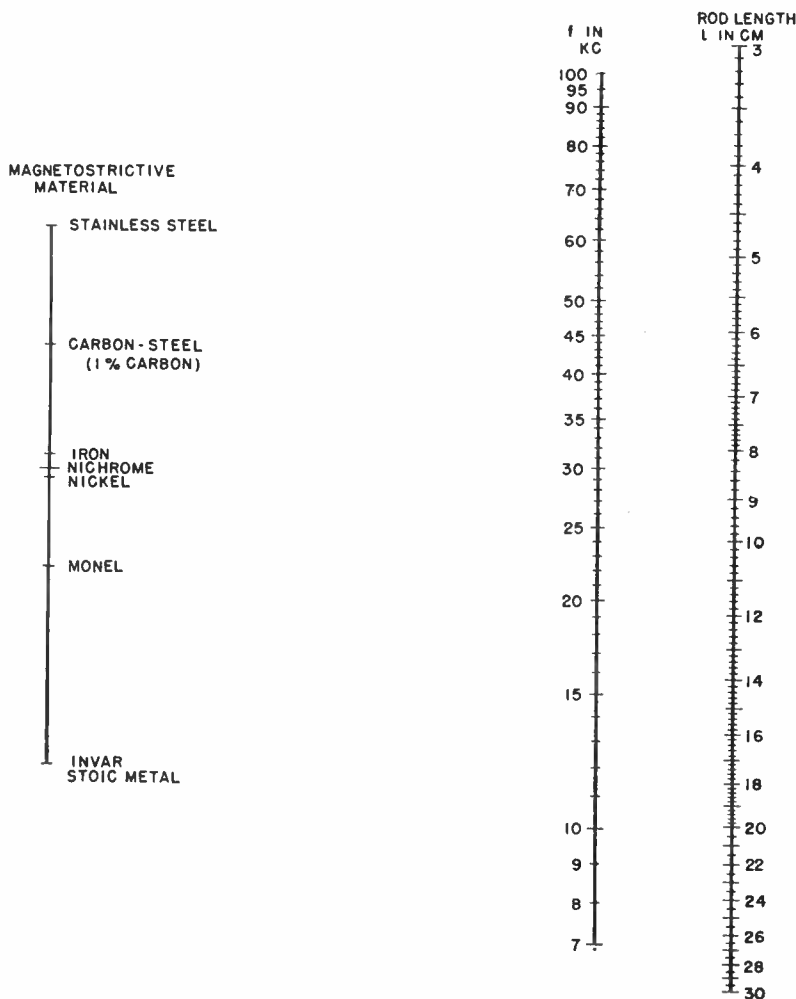

MAGNETOSTRICTION OSCILLATORS have been widely used in many electronic applications, particularly in underwater sound, since George Washington Pierce of Harvard first reported on his research in 1927.^{1,2} These oscillators have their frequency controlled by a magnetostrictive rod of nickel, Monel metal, Invar, Nichrome, Stoic metal, or other nickel alloys.

When a magnetostrictive rod or tube is placed in an alternating magnetic field and clamped or pivoted at the center of the rod, the resonant frequency of the rod is given by $f = v/2l$, where f is the resonant frequency in kc, v is the velocity of sound³ in the rod in cm per sec, and l is the length of the rod in cm.

The accompanying nomograph permits simple calculations of the resonant frequencies. Thus, to find the resonant frequency of a magnetostriction oscillator using a Monel metal rod 5 centimeters long, lay a straightedge between Monel metal on the magnetostrictive material scale and 5 cm on the rod length scale, and read the answer of 47 kc on the frequency scale.

REFERENCES

- (1) Patent 1,750,124, March 11, 1930, Vibratory System and Method. Application filed January 3, 1927.
- (2) G. W. Pierce, *Proc. Amer. Acad. Arts & Sci.*, Volume 63, April 1928. Reprinted in *Proc. I.R.E.*, Volume 17, p 42, 1929.
- (3) Bertha W. Hennis, Wavelengths of Sound, *ELECTRONICS*, p 134, March 1947.

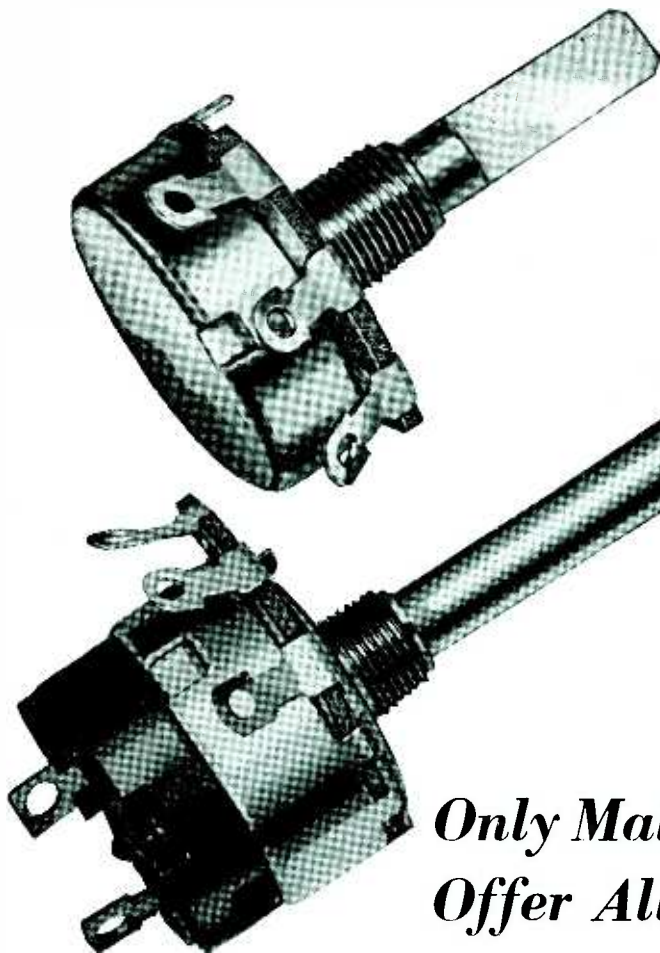

Low "Hop-Off" Resistance
Minimum Short-Out Resistance

Smooth-Operating Mallory Alloy Contactor

High Humidity Resistance

Low Noise Level

Extremely Accurate Taper Construction

Non-Distorting, Non-Loosening Assembly Construction

Spring Pressure Terminals, Smooth Bearing Surfaces, Mallory Alloy Spring Contact Arms, Self-Lubricating Elements—all contributing to longer life.

Only Mallory Carbon Controls Offer All These Features!

It's really surprising, when you do a little checking, to see how *much more* Mallory carbon controls have to offer. You learn what is meant when other people say, "You expect more and get more from Mallory."

For Mallory carbon controls have *almost* as many features as Mallory has years of experience in electronics and metallurgy. Add them together and you get what no other manufacturer can give you—workmanship, design, standards of quality that are worthy of the finest products you make. Contact our district sales office or write direct for new Mallory variable resistor engineering data booklet and specification sheet. Special engineering help is available, too.

P. R. MALLORY & CO. Inc.
MALLORY RESISTORS
(FIXED AND VARIABLE)

P. R. MALLORY & CO., Inc., INDIANAPOLIS 6, INDIANA

TUBES AT WORK

Including INDUSTRIAL CONTROL

Edited by VIN ZELUFF

Sprayed Metal for Wiring.....	132
Circuit Analyzer for the Blind.....	132
Cathode-Coupled Half-Shot Multivibrator.....	150
C-R Tube on Power Lines.....	158
Coax Coil for Heating Small Holes.....	160
Compact Power Supply for High Current.....	162
Hardening Shear Blades.....	164
River-Mapping by Radar.....	166
Brazing Lawn Mower Rotors.....	168

Sprayed Metal for Wiring

A NEW method of forming several electronic circuits at once consists of spraying metal into grooves in dielectric panels. A stencil is cut to coincide with the wiring diagram and the panel is sand blasted through the stencil to form grooves. Metal, copper, silver, or aluminum, is then sprayed through the stencil into the grooves. The

panels may be formed of plastic, ceramic, glass, or wood.

Tube sockets, capacitors and other parts are assembled on the panel prior to sandblasting or metallizing, with their contacts so placed that they will be in the proper grooves when the latter are formed. The contacts are spray-wired into permanent connection

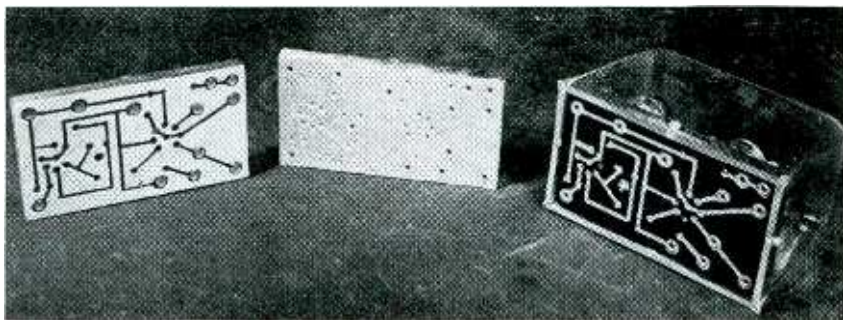

In the Spraywiring technique, a stencil is applied to a blank insulating panel, which is then sandblasted and sprayed with metal. It then appears as at center, with stencil still in position. A finished two tube amplifier is shown at right with stencil removed

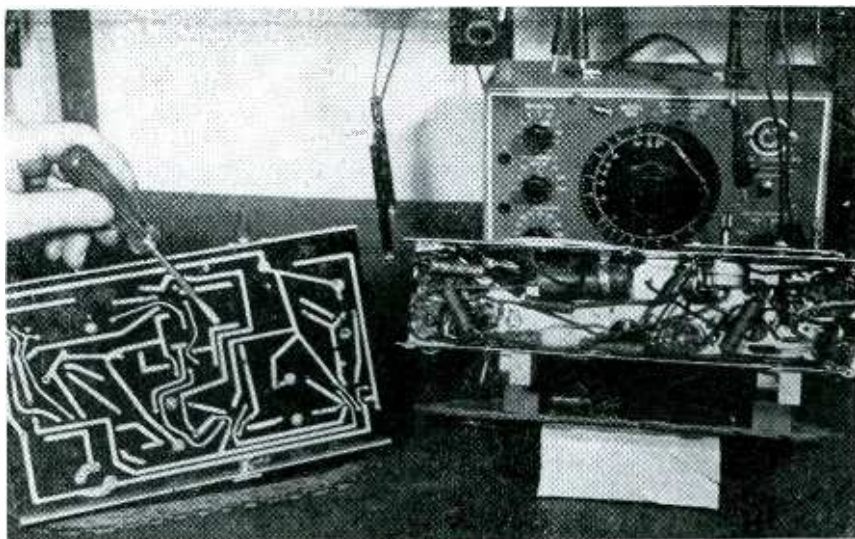

Underside view of a spraywired chassis and a conventional receiver having wires and soldered connections

with the circuit when the panel is sprayed. Both sides of a panel can embody sprayed conductors, and the conductors on opposing sides can be connected by metal eyelets prior to sandblasting or metallizing.

The thickness of the metal deposited is at least 0.005 inch. If insulation of a conductor is required, spraying, dipping, or brushing on suitable insulation material can be done. According to Spraywire Laboratories, Inc. of Minneapolis, Minn., the Spraywiring method is adaptable to the manufacture of many types of products which embody wiring. It can be used in producing the circuits of a tiny hearing aid, or the basic wiring of a prefabricated house. The metallizing equipment used in the spraying process is made by Metallizing Engineering Co., Inc.

Circuit Analyzer for The Blind

BY CLIFFORD M. WITCHER

Haskins Laboratories, New York City

SEVERAL MODELS of a multitester, capable of rapid and accurate use by the blind and essentially equivalent to moderately priced commercial circuit testers, were built and have proved to be quite satisfactory. The instrument, is considerably more rugged both electrically and mechanically than most commercial units, and measurements can be made with it at a comparable speed.

The analyzer embodies the equivalent of a multirange precision bridge-type ohmmeter, a multirange 2,000 ohms per volt d-c voltmeter, and a multirange d-c milliammeter. Measurements are obtained as nuls in an audible signal from a pair of headphones, and readings are easily taken from a single linear raised scale on the dial of an accurately linear potentiometer.

Addition of an external crystal rectifier or diode with suitable bias permits use as a peak reading a-c volt or milliammeter. Provision is also made for the insertion of external series resistors to provide any number of additional resistance

DIEFLEX

VARNISHED TUBING PRODUCTS

features of Superiority

EIGHT BUILDING BLOCKS

for electrical insulation . . .



If you are trying to cut costs on electrical assembly, be sure you are using the insulation that best meets your needs. Dieflex varnished tubing and sleeving has a proven reputation built on eight important points. Check them against your requirements:

- ✓ Complete impregnation
- ✓ Extreme flexibility
- ✓ Non-fraying quality
- ✓ Dielectric strength
- ✓ Completeness of line
- ✓ Good push-back quality
- ✓ Smooth inside bore
- ✓ Uniformity of product

Dieflex varnished tubing products are available in a wide range of types to meet every electrical insulation requirement. Every piece meets or exceeds VTA and ASTM standards. Ask about this superior insulation for your product.

DIEFLEX PRODUCTS LIST

MADE WITH BRAIDED COTTON SLEEVING BASE

VTA Grade A-1 Magneto Grade Varnished Tubings—VTA Grade B-1 Standard Grade Varnished Tubings—VTA Grades C-1 and C-2 Heavily Coated Saturated Sleeveings—VTA Grade C-3 Lightly Coated Saturated Sleeveings—Heavy Wall Varnished Tubings and Saturated Sleeveings.

MADE WITH BRAIDED GLASS SLEEVING BASE

VTA Grade A-1 Magneto Grade Varnished Fiberglas Tubings—VTA Grade C-1 Extra Heavily Saturated Fiberglas Sleeveings—VTA Grade C-2 Heavily Saturated Fiberglas Sleeveings—VTA Grade C-3 Lightly Saturated Fiberglas Sleeveings—Silicone-Treated Fiberglas Varnished Tubings and Saturated Sleeveings.

INSULATION

MANUFACTURERS CORPORATION

*CHICAGO 6
565 W. Washington
Boulevard
MILWAUKEE 2
312 E. Wisconsin Ave.
*Local Stocks Available



*CLEVELAND 14
1231 Superior
Ave., N. E.
DAYTON 2
1315 Mutual Home
Building

IMC Representatives

DETROIT 2—11341 Woodward Ave. • PEORIA 5—101 Heinz Court
MINNEAPOLIS 3—1208 Harmon Place

Authorized Distributors

INSULATION and WIRES INCORPORATED

St. Louis 3, Mo. • Atlanta 3, Ga. • Boston 20, Mass.
Detroit 2, Mich. • Houston 2, Tex. • New York 7, N.Y.

TRI-STATE SUPPLY CORPORATIONS

Los Angeles 13, Cal. • San Francisco 7, Cal. • Seattle 4, Wash.

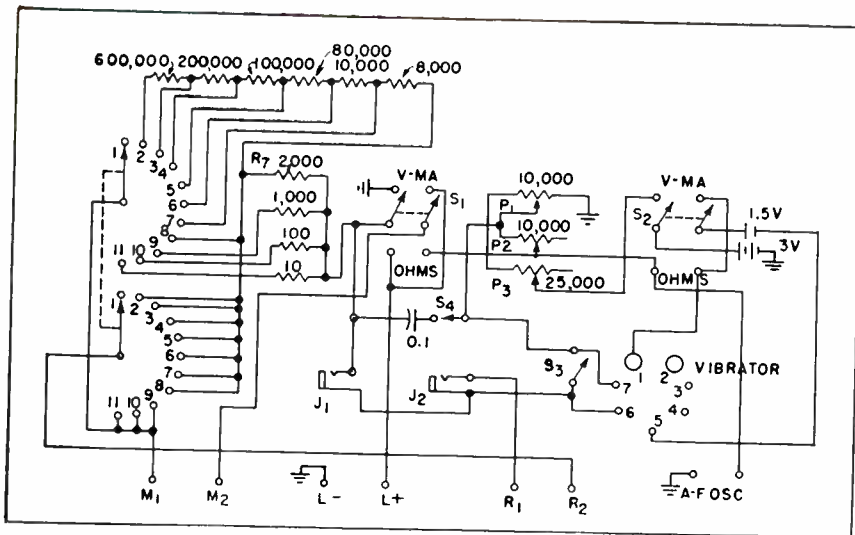

FIG. 1—Circuit of the multimeter that provides aural indication of measurements

or voltage ranges, and for the insertion of shunts to provide higher current ranges. The instrument may also be used as an a-c bridge by connecting an external audio oscillator to the binding posts provided for this purpose and by inserting suitable standard capacitors or inductances.

Theory and Operation

The circuit of the analyzer is illustrated in Fig. 1. Essentially, the instrument serves as a Wheatstone bridge, or as a voltage divider and potentiometer, depending upon the positions of the two converter switches S_1 and S_2 and the particular jack into which the phones are plugged.

Consider the action of switch S_1 if binding posts M_1 and M_2 are connected together. When the blades of this switch are down and an unknown resistance X is connected across binding posts $L+$ and $L-$, it can be seen that a bridge circuit is formed by (1) the portion of the measuring potentiometer P_1 between the grounded end and the movable contact; (2) the calibrating potentiometer P_2 ; (3) the unknown resistance X ; and (4) a portion of the resistance network associated with the range selector switch. With switch S_2 in the position correspond to that of S_1 , three volts are applied across one diagonal of this bridge, and a pair of phones inserted in the other diagonal, jack J_1 . The 2-volt vibrator, shunted by a microswitch push button (both nor-

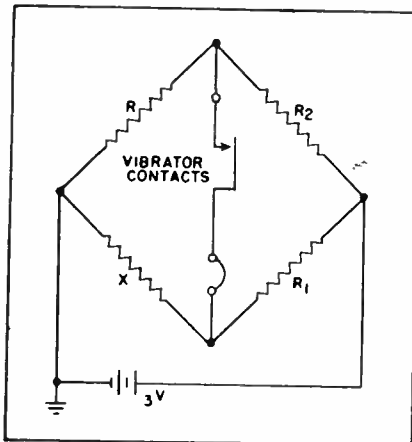

FIG. 2—Bridge circuit employed in the analyzer when resistance is being measured

mally open) are in series with the phones.

Referring to Fig. 2, let R_1 be the resistance selected by the selector switch, and R_2 the resistance of the calibrating potentiometer P_2 . When the instrument is in proper calibration, R_2 is set equal to the resistance of the portion of the measuring potentiometer P_1 between ground and full-scale position of the movable contact, a scale reading of 10.0. If the bridge is balanced for an unknown resistance X , by rotating the pointer of the measuring potentiometer until a null point is found, and if R is the resistance of the portion of the measuring potentiometer between ground and the movable contact, then $R/R_2 = X/R_1$. But calling the scale reading Y , and remembering the definition of R_2 , we have $R/R_2 = Y/10$ therefore $X = (Y/10) R_1$. Since the values used for R_1 are always multiples of

10, the value of X can be readily obtained mentally from the scale reading. Since the scale only extends to 11.0, X must be less than or equal to $1.10R_1$.

Voltage and Current

Consider now the action of the instrument when switches S_1 and S_2 are in the V-MA position, and the phones are in jack J_2 . Assume that binding posts R_1 and R_2 are connected together, as they are except when an external rectifier is to be used. For positions 2 through 8 on the range-selector switch, the resistance network associated with this switch is connected as a voltage divider, with the voltage drop across the 2,000-ohm resistor R_1 being opposed (through phones and vibrator) by the voltage between ground and the movable contact of the measuring potentiometer (See Fig. 3). The voltage across the measuring potentiometer is, in this case, obtained from the same flashlight cells mentioned above, but this time through the voltage calibration potentiometer P_2 . The latter is so adjusted that the voltage drop across the first 10 scale divisions of the measuring potentiometer is 1.0 volt. In practice it is found best to check the setting of P_2 by comparison with a reasonably

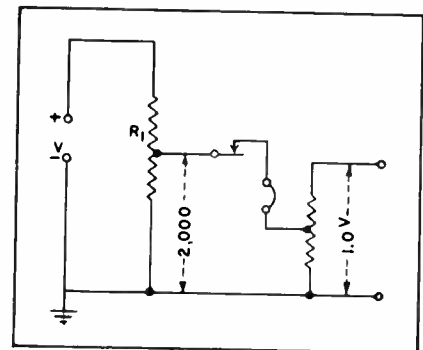

FIG. 3—Voltage divider and potentiometer arrangement for current and voltage measurements

accurate voltage source every few weeks.

With this circuit arrangement the voltage V corresponding to a given scale reading Y at which a balance has been obtained is $v = (y/10) (R_1/2000)$. In practice, one remembers the range selector switch settings as voltage ranges

(continued on p 148)

Good for as many as

One Billion

relay operations

... without maintenance!

Western Electric MERCURY CONTACT RELAYS

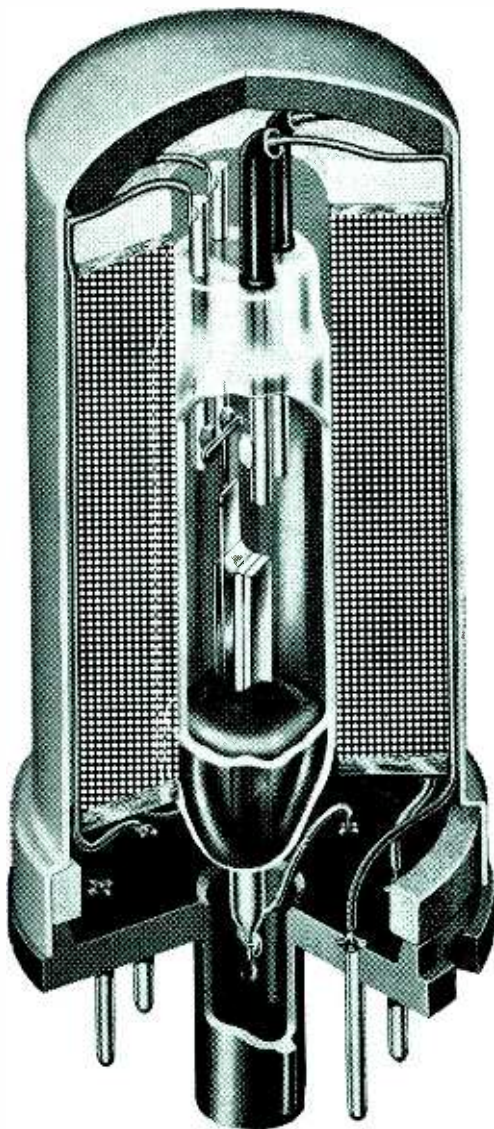

This cutaway view shows the glass sealed, mercury wetted contact switch surrounded by the operating coil and encased in a metal housing mounted on an octal base.

These new Western Electric Mercury Contact Relays—which make possible greater accuracy and dependability of high speed switching machines—virtually eliminate relay maintenance problems. They're hermetically sealed against dirt—immune to atmospheric conditions—completely tamper-proof—good for a billion or more operations.

Designed by Bell Telephone Laboratories, their uniformity of performance, circuit flexibility and mechanical stability make them particularly suited for applications such as:

Computing Machines	Tabulating Machines
Sorting Machines	Totalizers
Signaling Devices	Servo-Mechanisms
High Speed Keying Relays	Relay Amplifiers
Vibrator Power Supplies	

If you want relays that assure long service life—high operating speeds—large current and voltage handling capacities—and constant operating characteristics, the Western Electric 275 and 276 Type Relays are *just what you want!*

Get full details from your local Graybar Representative or send the coupon below to Graybar Electric Co., 420 Lexington Ave., New York 17, N.Y.



— QUALITY COUNTS —

Graybar Electric Co.
420 Lexington Ave., New York 17, N.Y.

E.M. 1

Gentlemen: Please send me descriptive literature on
Western Electric Mercury Contact Relays.

Name _____

Company _____

Address _____

City _____ State _____

THE ELECTRON ART

Edited by FRANK ROCKETT

Designing Automatic Controllers by Electrical Analogues.....	136
Steepness of Pulse Fronts.....	136
Voltmeter for Pulses.....	178
Pulse Rise and Decay Time Measurement.....	180
Survey of New Techniques.....	190

Designing Automatic Controllers by Electrical Analogues

DYNAMIC STABILITY and other performance criteria of automatic industrial controllers can be determined automatically using an electronic model of the system. Using this technique, the design of controllers is simplified by the Analaut (automatic analogue) designed by George A. Philbrick, G. A. Philbrick Researchers, Inc. (Boston, Mass.).

Electrical Analogue

The components of the controlled process are reduced to their electrical equivalents. The complete system, with either the actual controller or an electrical analogue of it, is then periodically shock excited and the recovery transients at appropriate points synchronously displayed on an oscilloscope. The behavior of the system for various adjustments of the process and controller is observed by manipula-

tion of the electrical circuit in direct correspondance with variations of the actual physical constants. For example, effects of lag times or valve limits can be analyzed.

Various electrical circuits are used to represent plant equipment. A series of tanks so connected that the fluid cannot back up, as where one tank overflows into another, is represented by resistance-capacitance networks isolated by vacuum tubes; if the fluid can back up, the tubes are omitted. The inverse of the technique is used to synthesize practical processes and plants from the required physical reactions. In addition, because the electrical analogue compresses into fractions of a second plant reactions occupying hours, it provides a means of quickly and graphically teaching automatic control techniques to plant operators. A classroom model



Operator observes effect of variations in simulated process control

has recently been successfully used at Massachusetts Institute of Technology. Special models have been used in designing and improving industrial controllers, and others are being used in designing nonreciprocating aircraft engine controls.

Steepness of Pulse Fronts

BY MILTON D. RUBIN

*Engineer, Raytheon Mfg. Co.
Dorchester, Mass.*

MOST ANALYSES of pulsed circuits assume that the wavefront of the pulse is a step function, such as

ELECTRONS RADIATE LIGHT

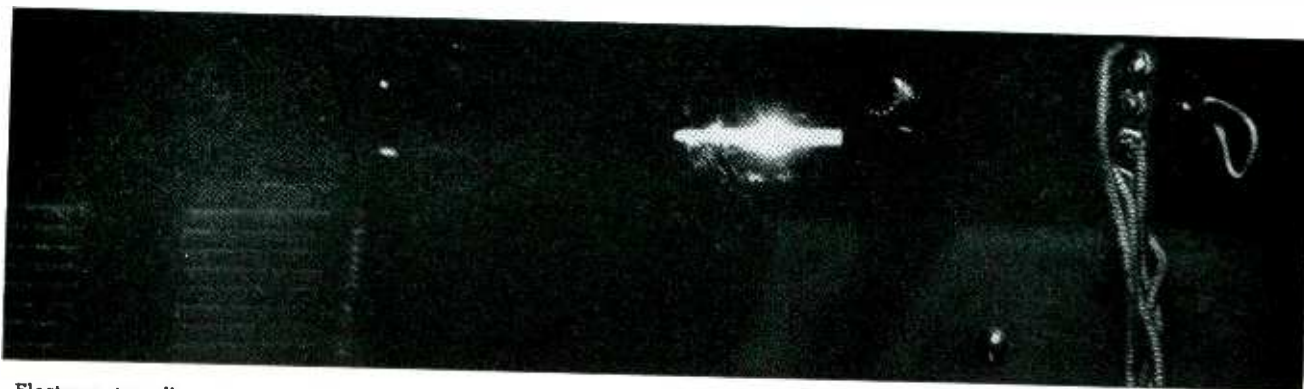

Electrons traveling at extremely high speed give off electromagnetic radiation directly. This electronic light has just been observed by Floyd Haber, laboratory assistant, working on the synchrotron in the General Electric research laboratory. The radiation, predicted in 1944 by two Russian physicists, D. Iwanenko and I. Pomeranchuk, is given off tangentially from the free wall of the synchrotron doughnut. Calculations by Dr. J. S. Schwinger of Harvard University indicate that maximum energy of the radiation is in the visible or infrared portion of the spectrum, with only slight energy in the microwave region. Dr. H. C. Pollock, physicists in charge of the synchrotron, and Drs. R. V. Langmuir and F. R. Elder, his associates, are preparing a flat quartz window in the doughnut wall so that measurements of the spectral content of the radiation can be made. Comparison of the measurements with calculations will provide further insight into the nature of the electron

PRECISION MEASURING INSTRUMENTS FOR THE RADIO AND ELECTRONIC INDUSTRY

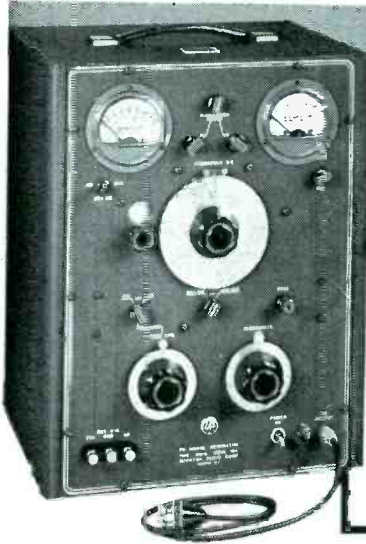

FM SIGNAL GENERATOR TYPE 202-B

RF COVERAGE: 54—216 megacycles in two ranges; accuracy $\pm 0.5\%$.
 FM DEVIATION: Two ranges, 0—80 kc., 0—240 kc., continuously adjustable.
 FM DISTORTION: Less than 2% at 75 kc. deviation.
 AMPLITUDE MODULATION: One range, 0—50%; calibrations at 30% and 50% modulation.
 INTERNAL MODULATING FREQUENCIES: Eight frequencies from 50 cycles to 15 kc.
 RF OUTPUT: 0.1 microvolt to 0.2 volt, continuously adjustable by means of 26.5 ohm piston type attenuator.



UNIVERTER TYPE 203-B

An FM-AM frequency converter accessory with unity gain for use with 202-B FM Signal Generator.
 RF RANGE: 0.4 mc. to 25 mc.
 RF INCREMENT DIAL: ± 250 kc. in 10 kc. increments.
 RF OUTPUT: 0.1 microvolt to 0.1 volt, calibrated output (26.5 ohms); 2 volts max. uncalibrated output (approx. 470 ohms).

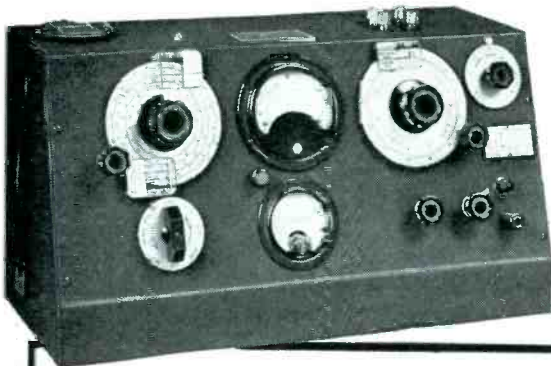

Q-METER TYPE 160-A

FREQUENCY RANGE: 50 kc. to 75 mc. ($\pm 1\%$, 50 kc.—50 mc.; $\pm 3\%$, 50 mc.—75 mc.). May be extended down to 1 kc. with external accessory oscillator.
 RANGE OF Q MEASUREMENTS, COILS: 50—625.
 ACCURACY OF Q MEASUREMENT: In general, $\pm 5\%$.
 RANGE OF Q TUNING CAPACITOR: Main Section, 30—450 mmf. ($\pm 1\%$ or ± 1 mmf., whichever is greater). Vernier Section, plus 3, zero, minus 3 mmf., (± 0.1 mmf.).

Q-METER TYPE 170-A

FREQUENCY RANGE: 30 mc. to 200 mc. ($\pm 1\%$).
 RANGE OF Q MEASUREMENT: 80—1200.
 ACCURACY OF Q MEASUREMENT: In general, $\pm 10\%$.
 RANGE OF Q TUNING CAPACITOR: 11—60 mmf. ($\pm 1\%$ or ± 0.5 mmf., whichever is greater).



BEAT FREQUENCY GENERATOR TYPE 140-A

FREQUENCY RANGE: 20 cycles to 5 megacycles in two ranges; LOW RANGE: 20 to 30,000 cycles. HIGH RANGE: 30 kilocycles to 5 megacycles. Accuracy ± 2 cycles up to 100 cycles, $\pm 2\%$ above 100 cycles.
 OUTPUT POWER: One watt, available from a variety of output impedances.
 ATTENUATOR: 5 steps; X1.0, X0.1, X0.01, X0.001, X0.0001.
 DISTORTION: 5% or less.

QX-CHECKER TYPE 110-A

FREQUENCY RANGE: 100 kc. to 25 mc. using accessory plug-in inductors. A calibration sheet is supplied with each inductor, accurate to within $\pm 3\%$.
 RANGE OF COIL CHECKS: Inductors having values between 10 microhenries and 10 millihenries may be checked against a standard to an accuracy of about $\pm 0.2\%$ provided the Q of the inductor is 100 or greater.
 CAPACITANCE RANGE: Capacitance values between about 2—1000 mmf. may be checked against standard by direct substitution, with an accuracy of a few tenths of one mmf., provided Q of capacitors is high.



Write for further information



BOONTON RADIO
 CORPORATION

BOONTON · N.J. · U.S.A.

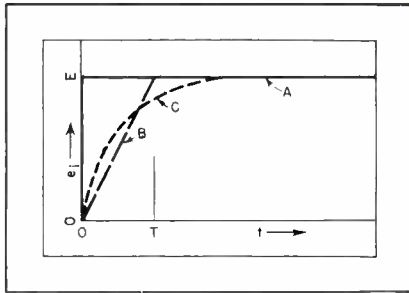

FIG. 1—Pulse front can be approximated by a step function (curve A), a linearly rising front (curve B), or an exponentially rising front (curve C)

curve A in Fig. 1. Actually it is physically impossible for a voltage or current to change instantaneously from one value to another. Therefore a wavefront cannot have infinite slope as implied by this function. There are cases in which this assumption of a perfectly square pulsefront leads to erroneous results. In these cases the following analysis gives better results with no greater complexity.

Linearly Rising Pulse Front

Often it is appropriate to assume an infinite slope as a first approximation, and to interpret the results accordingly. However when this approximation gives incorrect results (One of the principal cases being an analysis of pulse differentiation), a second approximation to the solution, a linearly rising pulsefront such as curve B in Fig. 1, which is close enough to be of great practical help, can be assumed. A fairly complete analysis of this problem has assumed exponential rise of the pulse, such as Curve C in Fig. 1, which might be considered as a third and even closer approximation¹.

Nevertheless, assumption of a linear rather than exponential rise may, at times, be more accurate, as the rise is often linear until just before flattening out, particularly when peaking circuits are used.

What the practical electronic designer prefers is a few rules of thumb for quick application to various cases, especially when numerous stray effects need to be considered and the circuit values are not accurately known.

Assume a linear rise of the pulse. By way of illustrating the approach, a simple R-C circuit, shown in Fig. 2, is considered because of its sim-

licity and wide application. Likewise, the essentials of the mathematical analysis are given because of their simplicity and because the method can be used for other circuits.

The voltage rises from 0 to E in time T, therefore the rate of rise is E/T, and the input voltage is $e_i = Et/T$. The current can be found by dividing the operational transform expression for the voltage by

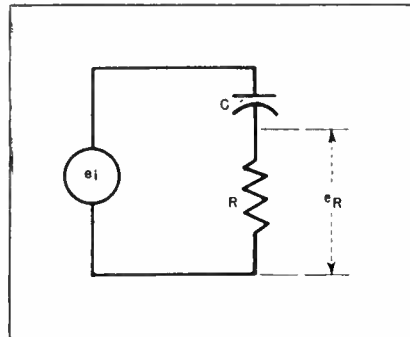

FIG. 2—Curves in Fig. 3 pertain to this simple but common circuit

the operational transform for the impedance, and solving for the current by known equivalences (The operational transform method, giving direct solutions of pulse transmission problems, should be at every electronic engineer's fingertips.), or by contour integration in the complex plane. The expression for the voltage by the operational transform method^{2,3}, for the rise period, is therefore E/Tp , where p is the well known operator. The impedance is $R + 1/Cp$, thus

$$i :: \frac{E/Tp}{R + 1/Cp} \quad (1)$$

where $::$ denotes operational transform equivalence. The solution is

$$i = (CE/T) (1 - e^{-t/RC}) \quad (2)$$

Usually we are interested in the voltage across the resistor. This voltage is

$$e_R = (RCE/T) (1 - e^{-t/RC}) \quad (3)$$

which is of the form of curve C in Fig. 1.

Interpretation of Results

To interpret this equation into practical rules of thumb, let us consider several cases, realizing that for the present we are considering only the rise period.

First, for t considerably less than RC

$$e_R = Et/T \quad (4)$$

Thus the voltage follows and is equal to the input voltage, as it also has this equation. If T is considerably less than RC , then the whole wavefront is transferred faithfully across the resistor.

For the second case, consider T approximately equal to RC . Then $t = T = RC$, substituting in Eq. 3

$$e_R = (RCE/RC) (1 - e^{-1}) = 0.6321E \quad (5)$$

or e_R is approximately $(2/3)E$. The voltage across the resistor thus rises exponentially to about $(2/3)E$, and there is some differentiation and loss in voltage.

For the third case, consider when the wavefront rises to its full value in time $t = T = 3RC$. Here again the voltage rises exponentially to its final value, which is, from Eq. 3

$$e_R = (E/3) (1 - e^{-3}) = (0.95/3)E \quad (6)$$

or e_R is approximately $(1/3)E$. In this case we have lost $2/3$ of the voltage, and are now in the region in which many differentiating circuits work. The analysis indicates that, unless the rise time of the input voltage is about the same as or less than the time constant of the differentiating circuit into which it is working, much of the voltage is lost in passing through the circuit.

For the fourth case, consider a rise time very much larger than RC . For $t = T = aRC$, where a

(continued on p 172)

FRENCH ATOMIC PILE



Electronic instrumentation is being used extensively at plants outside Paris, France in developing nuclear piles, first step in manufacture of radioactive materials

Put This Formula To Work For You

$$I = \frac{E}{IRC}$$

The formula $I = \frac{E}{IRC}$ is a favorite and easily-remembered solution to resistance problems. Radio and electronic Engineers know that IRC offers the most complete line of resistance products in the industry . . . a fixed or variable resistor for most every requirement . . . with uniform dependability proved by years of rigorous laboratory and field tests. Purchasing Agents and material control executives like IRC's service . . . "on-time" deliveries . . . factory stock-piles of the most popular types and ranges from which they can draw in emergency . . . IRC's distributor network, providing speedy, 'round-the-corner service for small order requirements.

Put this formula to work for you . . . check below the catalog bulletins in which you are interested, and write for them today on your letterhead, giving your name and title. International Resistance Company, 401 N. Broad Street, Philadelphia 8, Pennsylvania. In Canada: International Resistance Company, Ltd., Toronto, Licensee.



INSULATED COMPOSITION INSULATED WIRE WOUND RESISTORS
IRC types BT & BW



FINGER-TIP CONTROLS AND SWITCHES
IRC types H & SH



WIRE WOUND RESISTORS
IRC type MW

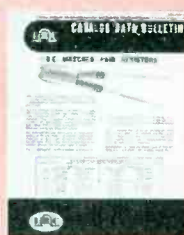

MATCHED PAIR RESISTORS



POWER RESISTORS



FLAT POWER RESISTORS
IRC type FRW

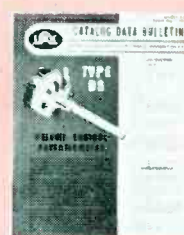

VOLUME CONTROLS
IRC type DS



WIRE WOUND POTENTIOMETERS
IRC type W



VOLTMETER MULTIPLIERS
IRC types MFA & MFB

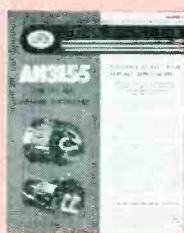

POWER RHEOSTATS
IRC types PR & PRT



WATER-COOLED RESISTORS
IRC type LP



PRECISION RESISTORS



HIGH VOLTAGE RESISTORS
IRC type MV



HIGH POWER RESISTORS
IRC type MP

INTERNATIONAL RESISTANCE COMPANY

Wherever the circuit says $\sim\sim\sim$

Power Resistors • Precisions • Insulated Composition Resistors • Low Wattage Wire Wounds • Rheostats • Controls • Voltmeter Multipliers • Voltage Dividers • 50W and High Voltage Resistors

NEW PRODUCTS

Edited by A. A. McKENZIE

New equipment, components, packaged units, allied products; new tubes. Catalogs and manufacturers' publications reviewed.

Audio Compensator (1)

ARLINGTON ELECTRICAL PRODUCTS, INC., 18 West 25th St., New York 10, N. Y. The model EA-2 audio compensator is particularly applicable for use in audio equalization



of film and disc recording and broadcast studio work. The rack-mounted equipment is completely described in curves and a specification sheet available from the manufacturer.

Small Multipole Relays (2)

LEACH RELAY Co., 5915 Avalon Blvd., Los Angeles 3, Calif. A new line of small multipole relays is now available for circuits not exceeding

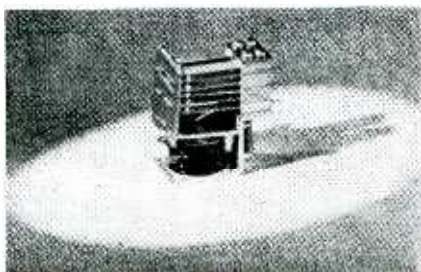

12.5 amperes, noninductive, in combinations up to 4-pole double-throw. Coils can be furnished for a-c or d-c operation. Full details are given in Bulletin 202.

F-M/A-M Tuner (3)

COLLINS AUDIO Products Co., 126 Park St., Westfield, N. J., announces the new f-m/a-m tuner which pro-



vides the finest possible reproduction from the present broadcast band. Frequencies up to 10,000 cycles are passed without loss. The combination of two separate tuners, having only the audio tube common to both, eliminates dead spots due to interaction. Other features are the new tuning eye (6AL7-GT) to provide the accurate tuning necessary on the f-m band, and the heavy duty power supply which is an integral part of the chassis making for compactness. A total of 17 tubes is used in the tuner.

Broad Band Antenna (4)

F. A. KOLSTER, VIENNA, VA. The broad band antenna illustrated can be used for both f-m bands and the



television channels without readjustment. Bidirectional characteristics of the antenna are essentially the same over the range 40.9 to 210 mc. Graphs showing gain relative to a dipole, standing wave ratios and measured field patterns can be obtained from the manufacturer.

Wired Music Amplifier (5)

THE LANGEVIN Co., INC., 37 West 65th St., New York 23, N. Y. The model 610 amplifier designed for wired music has a power output of 20 watts with less than 2 percent rms total harmonic distortion from

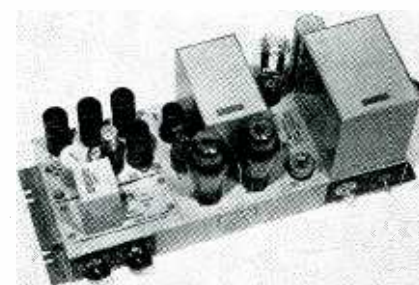

50 to 15,000 cycles. Input and output circuits are particularly arranged for connection between telephone line and speakers or distribution system. Full engineering details are available in a 4-page two-color brochure.

Tuning Fork Standard (6)

AMERICAN TIME PRODUCTS, 580 Fifth Ave., New York 19, N. Y. Type 2001 tuning fork frequency standard is available for any frequency in the range from 200 to 1,000 cycles. The fork, of bimetallic construction, is housed in a hermetically sealed, shock-mounted container. Output is 5 volts at 150,000 ohms, approximately a sine wave. Frequency accuracy is 0.001 percent and the temperature coefficient

USING THE NUMBERS

Readers desiring further details concerning any item listed in the New Products department can obtain the information by using the cards furnished as a stiff, colored insert elsewhere in this department.

Place the number (appearing to the right of the heading) of one item in which you are interested in a circle and then fill out the balance of the card according to directions appearing on the colored sheet. Unnumbered items listed at the end should be procured direct from the manufacturer or publisher upon payment of the fee noted.

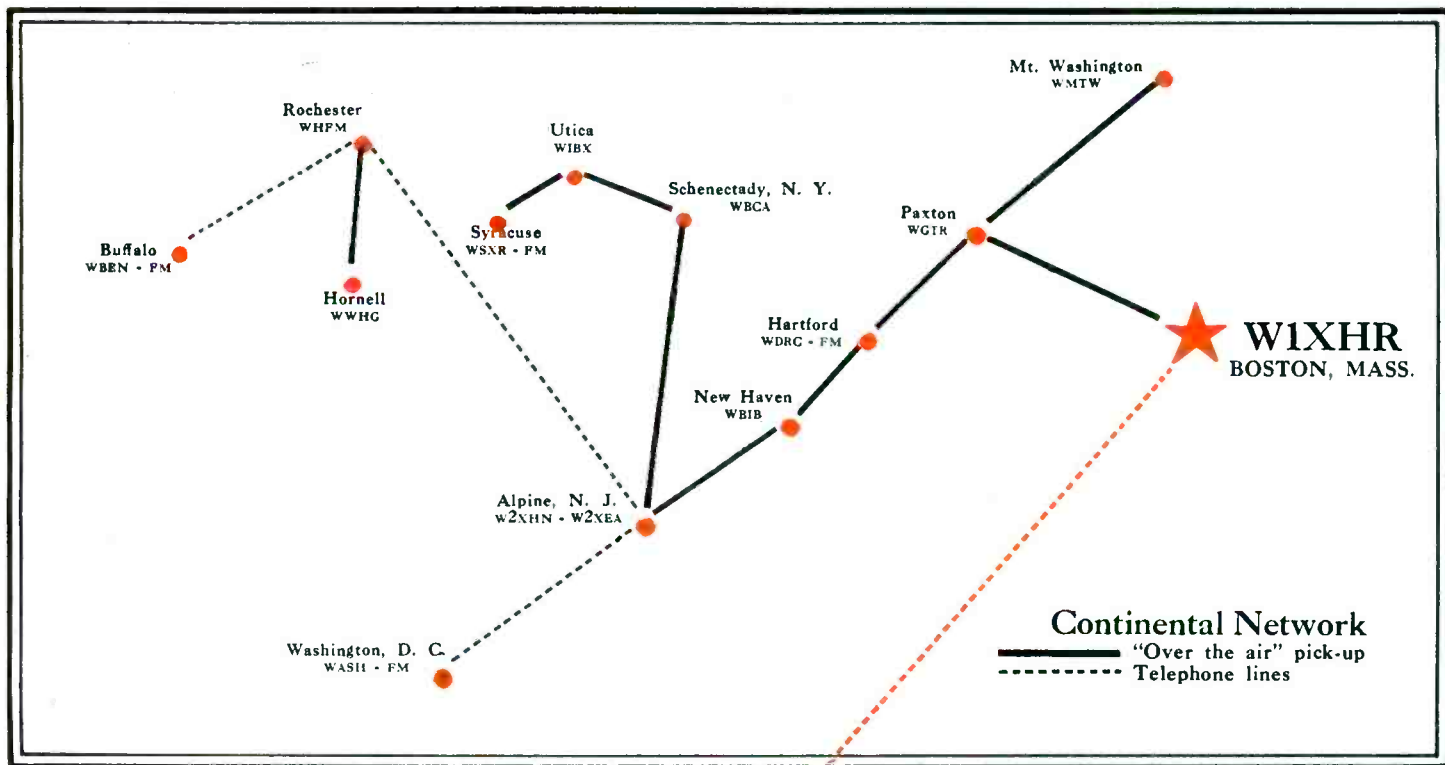

The FM Receiver with Network Experience

In the recently formed Continental Network, W1XHR, Harvey's High Fidelity FM station, serves as the FM outlet for Eastern Massachusetts. Programs originating in Washington, D. C. are received from WGTR in Paxton, Mass. on 103.1 Mc. and rebroadcast on 92.1 Mc. Harvey's 193-R High Fidelity FM receiver is used as the Relay-Link receiver at W1XHR and furnishes quality audio signals to its transmitter for rebroadcast purposes.

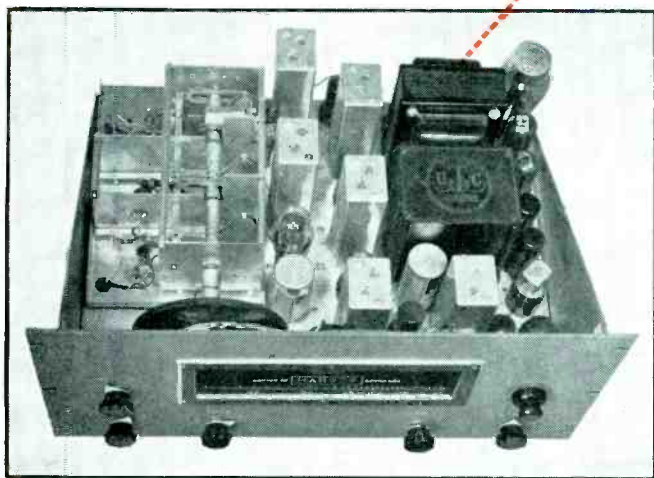

The Model 193-R High Fidelity FM Receiver (top view) employs a double conversion superheterodyne circuit using two I.F. channels 10.7 Mc. and 4.6 Mc.

Price \$490 f.o.b. Cambridge, Massachusetts

CHARACTERISTICS:

Frequency Range: 85 to 115 Mc.

Audio: an extremely high fidelity audio system is used, providing flat response from 10 to 40,000 cycles.

Sensitivity: RMS quieting signal of 1 microvolt.

Bandwidth: 250 Kc., adequate to pass the sidebands produced by 15 Kc. modulation, without appreciable band-edge attenuation.

Squelch Circuit: smooth, fast acting and adjustable from .1 microvolt to 1 microvolt.

Size: 21½" x 10½" x 15", available in an attractive gray wrinkle-finish cabinet.

Write for



further information

HARVEY RADIO LABORATORIES, INC.

439 CONCORD AVENUE • CAMBRIDGE 38, MASSACHUSETTS

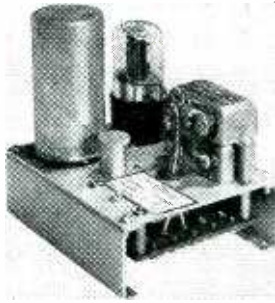

is better than 1 part in a million per degree Centigrade from 0 to 65 C. Other types are also available.

Microscillograph (7)

CENTRAL RESEARCH LABORATORIES, Inc., Red Wing, Minn. A new high-speed microscillograph now in production extends the range of application of single-sweep recording by

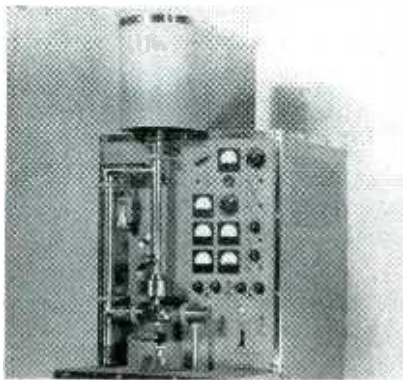

a factor of 10 in frequency over previous limits. Recordings of three simultaneous phenomena at frequencies up to 10,000 megacycles have been made.

Reproducers (8)

RADIO-MUSIC CORP., East Port Chester, Conn. Vertical, lateral or universal heads with linear response from 40 to beyond 11,000 cycles, together with arms and an equalizer are now in production under the name Para-Flux. Bulletin PR6 gives



full details of interest to broadcasters, recording studios, theaters and other users of recordings.

High Frequency Converter (9)

COLUMBUS ELECTRONICS INC., 229 So. Waverly St., Yonkers, N. Y. The model HFC 610 converter is



available in two ranges, 27 to 30 mc and 50 to 54 mc. When connected to a communications receiver it provides sharp tuning and image-free reception. It is further described in Bulletin C5.

Studio Recorder (10)

FAIRCHILD CAMERA & INSTRUMENT CORP., 88-06 Van Wyck Blvd., Jamaica 1, N. Y. A new studio recorder of console type accommo-



dates all sizes of acetate and 18-inch flowed wax masters. The model 523 unit operates at 33½ rpm and will cut either outside-in or inside-out at any pitch between 80 and 160 lines.

Multicrystal Holder (11)

VALPEY CRYSTAL CORP., Holliston, Mass. Two or three transmitting crystals in a common holder can be used in sequence by turning a



knurled rim. The unit accommodates crystals mounted in holders having 0.094 diameter pins with half-inch spacing. The Xtalector can be supplied in two types to fit either ½ or ¾-inch sockets.

Neon-Glow Voltmeter (12)

INDUSTRIAL DEVICES, INC., 22 State Road, Edgewater, N. J. A midget neon-glow voltmeter is calibrated



for use on a-c from 65 to 660 volts with an impedance of 0.5 megohm. Voltage is read directly from the scale. When connected to a d-c source, only one electrode glows and the reading is multiplied by 1.15.

Pickup Arm (13)

VIBRO-MASTER CO., 144 West 54th St., New York 19, N. Y. A new pickup arm, type K, has been particularly designed for use with the GE variable reluctance and the



(continued on p 194)

SPRING LOCK NUT

REVOLUTIONARY NEW FASTENER

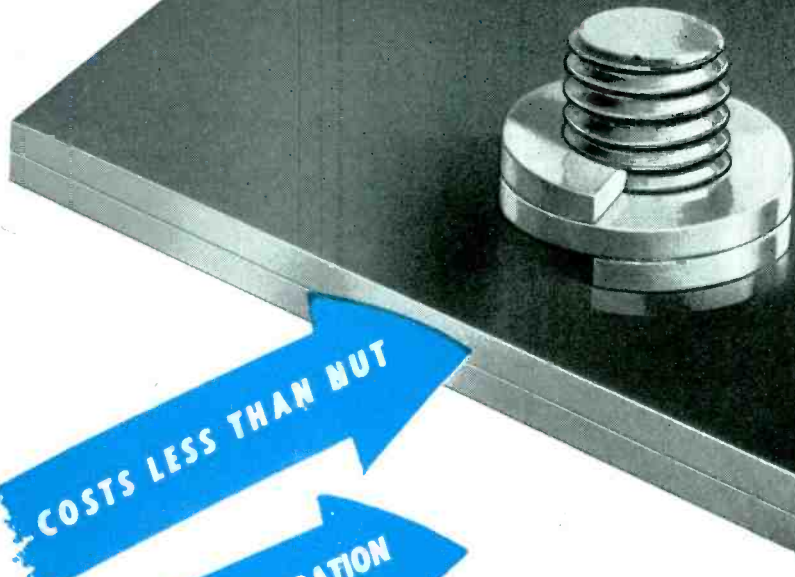

- COSTS LESS THAN NUT
- ELIMINATES ONE OPERATION
- SURE LOCK FOR BOLT
- SPEEDS PRODUCTION
- EASILY ASSEMBLED

CUTS TIME . . . MATERIAL . . . COSTS

Available in Two Types—Spring Nut and Spring Lock Nut

PROVED BY TESTS and hard usage on all kinds of products this new, revolutionary fastening device is already saving time, material and money for the nation's progressive manufacturers.

TWO TYPES of this new Diamond G Product, manufactured by the Garrett Company, are available. One replaces the conventional nut and is called the Diamond G Spring Nut. The other is made with spring action tension in it in such a way that it supplies action similar to that of a lock nut—the threads inside of the Diamond G Spring Lock Nut maintain a strong grip on the bolt, or screw and the tighter it is drawn up the greater the locking action.

AVAILABLE IN TWO AND THREE TURNS—depending on the requirements. The

two turn type is for use on light assemblies and the three turn type is recommended when it is necessary to use heavy tightening torques on assembly.

FOR DRIVING OR SETTING—adaptable socket wrenches are now standard items as manufactured by Apex Machine and Tool Company. These new Diamond G Products—Spring Nut and Spring Lock Nut—have all of the advantages of regular nuts and are adaptable for use in hopper feeders. Both types are priced to offer a considerable saving over the conventional type of nut, or fastening device. These products are available in rust resisting metal as well as high carbon steel.

START YOUR PLANT on greater efficiency today . . . write for the complete data sheet on these new Diamond G time and money saving products.

GEORGE K. GARRETT CO., INC.

1421 CHESTNUT STREET, PHILADELPHIA 2, PA.

Manufacturers of



DIAMOND PRODUCTS

LOCK WASHERS • FLAT WASHERS • STAMPINGS • SPRINGS • HOSE CLAMPS • SNAP AND RETAINER RINGS

NEWS OF THE INDUSTRY

Edited by JOHN MARKUS

Technical programs of NAB Engineering Conference, Instrument Conference, and Western IRE Conference; status of facsimile; radar

Tracking Stations for Guided Missiles

INSTRUMENTATION capable of showing the speed, trajectory, range, and other characteristics of guided missiles for approximately the full 90-mile length of the White Sands Proving Grounds, Las Cruces, New Mexico, is to be installed by the Army Corps of Engineers in cooperation with the U. S. Navy.

The construction program calls for the erection of approximately 75 additional instrumentation stations of various types and sizes, dust-proofed as necessary to house

doppler and radar equipment, tracking cameras, cine-theodolites and other paraphernalia.

Rapid developments in the guided missiles program have resulted in greater range of the missiles, and additional stations are necessary to enable observations and plotting of trajectories in the entire flight of such missiles.

As part of the coordinated program, the Army Air Forces also is installing a network of radar and other equipment to supplement the

installations by Army Ordnance and the Navy. Both Army and Navy have firing stations at the White Sands Proving Grounds.

Electronics Conference In Chicago Nov. 3-5

THE COMPLETE program for the National Electronics Conference at the Edgewater Beach Hotel in Chicago Nov. 3-5 includes 20 technical sessions with a total of about 50 papers, two luncheons, and the main banquet, in addition to the general session Monday morning. Technical details of the new dynamic noise suppressor circuit invented by Herman Hosmer Scott will be released, and manufacturers will stage educational exhibits.

Major emphasis in the technical program is placed on industrial electronics, having a total of three sessions, with one of these arranged by the AIEE in connection with their national convention in Chicago the same week.

One session will be devoted to commercial, f-m, and television broadcasting, and another to color television and oscillography. Other papers will deal with new types of antennas and with instrumentation, and a panel discussion on electronic research will be led by experts in the field. Subjects of general interest to all will include guided missiles, electronic computers, ultrasonics, infrared, microwaves, audio circuits, and detection of particles.

PUTTING SOUND ON INDUSTRIAL MOVIES

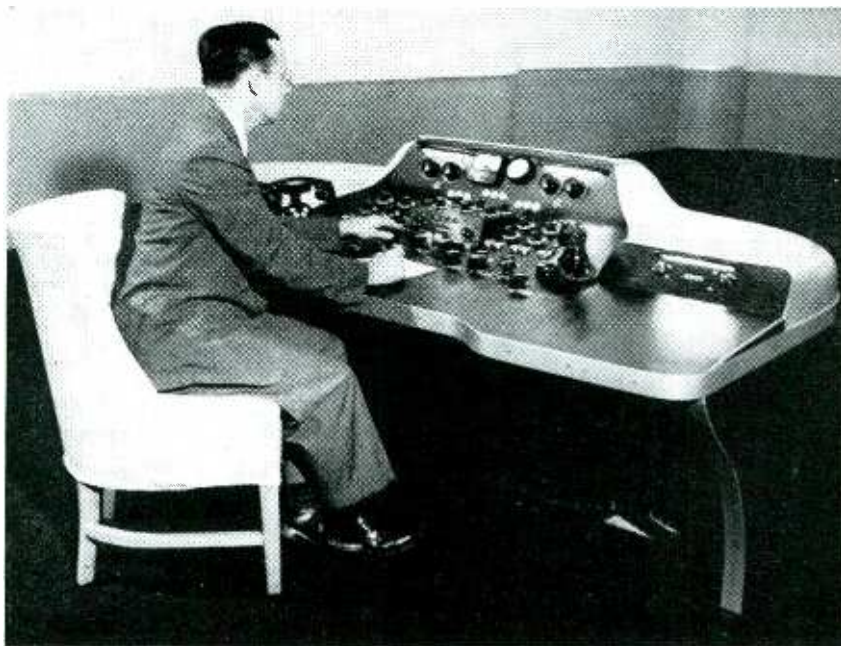

This ultramodern audio console in the projection room of Reeves Sound Studios, New York City, is capable of mixing eight channels to a single output, as required for putting narration, music, and sound effects on sound tracks of industrial films with precise synchronization. Operator records footage at which each sound source comes in, along with all required data on volume level changes and fading schedules. Many practice runs are made before final sound channel is photographically recorded on the film. New Reeves studio provides over five floors of sound stages, shooting stages, recording rooms, and sound laboratories for recording sound for film, records, radio, and television

Pay-As-You-See Television

A METHOD of charging a fee for a particular television program, its amount varying with the nature of the entertainment, was recently announced by Zenith Radio Corporation. Known as Phone Vision, it operates by sending a vital portion of the picture signal over a telephone or electric power line to the user. Without this signal the picture is a confused and jumpy blur.

In operation, the subscriber would call the telephone operator when he desired to see a special program, and would receive it by

IF IT'S UHF EQUIPMENT

WE CAN

- DESIGN
- DEVELOP
- PRODUCE IT!

LAVOIE LABORATORIES are specialists in high frequency work. We can begin with your own ideas — design, develop and produce; or we can manufacture (in any quantity) from your blueprints.

In either event, we can do a business-like job because we have the personnel and equipment for precision work plus a background of practical experience.

A few typical examples of LAVOIE-produced equipment are shown, including Frequency Standards—Frequency Meters—Receivers, etc.

Complete information and detailed estimates of LAVOIE service are available promptly without obligation.



Lavoie Laboratories

RADIO ENGINEERS AND MANUFACTURERS
MORGANVILLE, N. J.

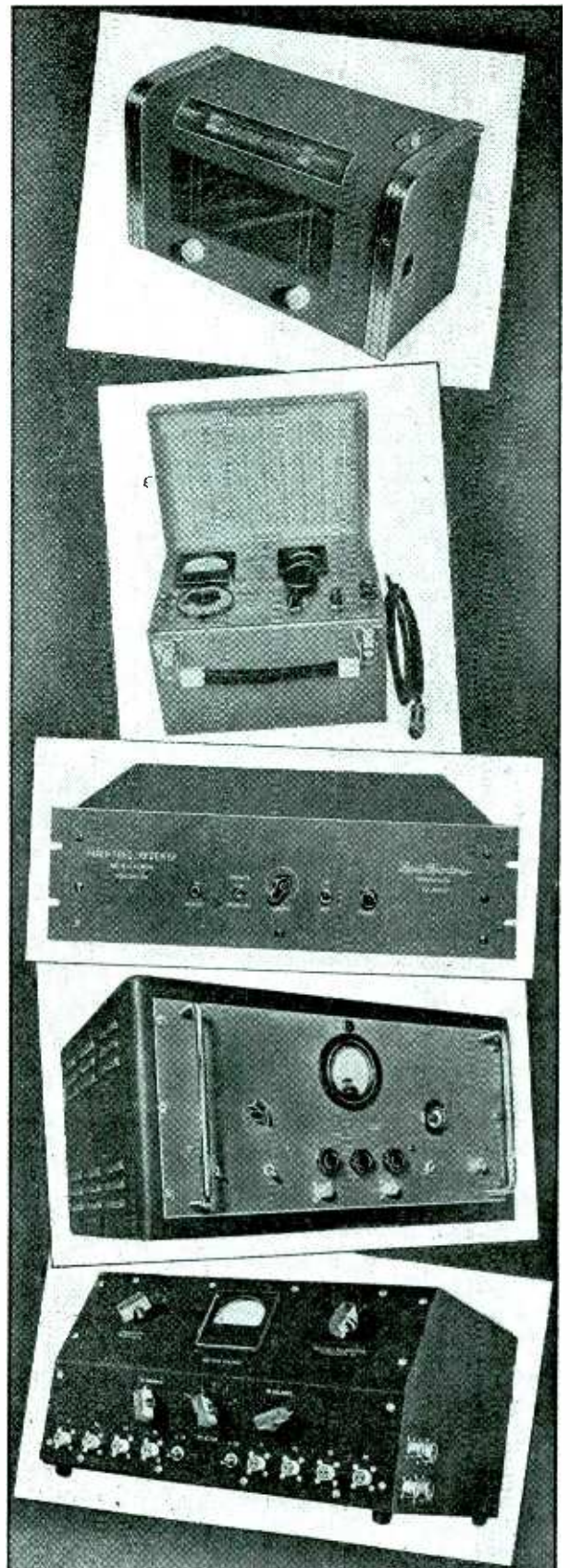

Specialists in the Development and Manufacture of UHF Equipment

MEETINGS

AUG. 26-29: AIEE 1947 Pacific General Meeting, Hotel San Diego, San Diego, Calif.

SEPT. 8-12: Second Annual Conference and Exhibit of The Instrument Society of America, at Stevens Hotel, Chicago.

SEPT. 12-13: FMA convention and exhibits, Roosevelt Hotel, NYC.

SEPT. 15-18: Annual convention and exhibit, National Association of Broadcasters, Convention Hall, Atlantic City, New Jersey.

SEPT. 23-25: AIEE Middle Eastern District Meeting, Dayton, Ohio.

SEPT. 24-26: West Coast IRE Convention, Palace Hotel, San Francisco, Calif., Prof. Karl Spangenburg, general chairman, Stanford University, Palo Alto, Calif.

SEPT. 26-28: Third annual Electronics Trade Show, Hotel Whitcomb, San Francisco, sponsored by West Coast Electronic Manufacturers' Association, W. Noel Eldred, secretary, care of Hewlett-Packard Co., Palo Alto, Calif.

SEPT. 26-28: Hudson Division ARRL Convention, Convention Hall, Asbury Park, N. J.; technical papers and exhibits of electronic equipment for radio amateurs.

SEPT. 29-OCT. 2: Annual meeting, International Municipal Signal Associa-

tion, Inc., Pantlind Hotel, Grand Rapids, Michigan; technical papers and exhibits of police and fire radio equipment.

SEPT. 30-OCT. 11: National Radio Exhibition, Olympia Hall, London, sponsored by British Radio Industry Council and featuring new British radio, electronic control, radar, and television equipment.

OCT. 20-24: SMPE Theater Engineering Conference, Hotel Pennsylvania, New York.

OCT. 23-25: Annual Meeting, Optical Society of America, Netherland Plaza, Cincinnati, Ohio; symposium on microwave optics.

Nov. 3-5: National Electronics Conference, Edgewater Beach Hotel, Chicago.

Nov. 3-7: AIEE Midwest General Meeting, Chicago, Ill.

Nov. 7-8: Conference on X-ray and Electronic Diffraction, Mellon Institute of Industrial Research, Pittsburgh, Pa.

Nov. 17-19: Rochester Fall Meeting, Sheraton Hotel, Rochester, N. Y.; technical papers and exhibits.

MARCH 22-25: IRE Convention and Radio Engineering Show, Hotel Commodore and Grand Central Palace, New York City.

ler-Hammer, Inc., Federal Telephone & Radio Corp., General Electric Co., The Girdler Corp., Induction Heating Corp., Lebel High Frequency Laboratories, Inc., RCA Victor Division, and Weltronic Co.

NAB Engineering Conference

ENGINEERING progress in television, f-m, and standard a-m broadcasting will be stressed at the day-long engineering conference that opens the annual convention of the National Association of Broadcasters in Convention Hall, Atlantic City, N. J. Sept. 15-18. The agenda, prepared under the direction of Royal V. Howard, NAB director of engineering, is as follows:

Sept. 15, morning session, presided over by Orrin W. Towner, chairman of NAB engineering executive committee and technical director of WHAS, Louisville, Ky.:

Recent Television Developments, by O. B. Hanson, vice-president and chief engineer of National Broadcasting Co.; emphasis on photography of kinescope images; illustrated with motion pictures.

Frequency Modulation Broadcast Station Construction, by Paul A. de Mars of Raymond M. Wilmette, Inc.

Audio Considerations for Broadcast Stations, by John D. Colvin, audio facilities engineer at American Broadcasting Co.

Sept. 15, afternoon session, presided over by Royal V. Howard:

Transmitter Maintenance for Small and Medium-Sized Stations — symposium, con-

means of an attachment on the telephone line. He would be billed at the end of each month for the special programs actually received, much as he is now billed for long-distance calls. All standard television broadcasts would be free, and the key signal would be used only for top-flight entertainment features such as new superpictures, Broadway plays, current newsreels, and special sporting events. These features are not available for ordinary television because their high production costs make them far too expensive for an advertising sponsor.

In making the announcement, Commander E. F. McDonald, Jr., Zenith president, stated that up to a year would be required to get the system in operation in a few key cities now having television, that Phone Vision sets would soon be in production, and that existing television transmitters can easily be altered.

NEMA Establishes Electronic Heating Group

ELEVEN manufacturers of induction and dielectric heating equipment have formed a new Induction and Dielectric Heating Apparatus Section within the National Electrical Manufacturers Association. Chairman is Dr. H. B. Osborn, Jr., sales manager of the Tocco Division of The Ohio Crankshaft Co., and vice-chairman is C. W. Miller, sales manager of Westinghouse's Industrial Electronics Division in Baltimore.

The section was formed to insure greater benefits to users of high-frequency heating equipment by such means as establishing equipment standards and ratings, prescribing uniform safety requirements, and studying other factors affecting efficiency, production, and costs of heating.

Other companies participating are Allis-Chalmers Mfg. Co., Cut-



R. V. Howard



O. W. Towne



O. B. Hanson



P. A. de Mars
(continued on p 241)

Now available



TECHNICAL PURPOSE - DUAL BAND FM RECEIVER

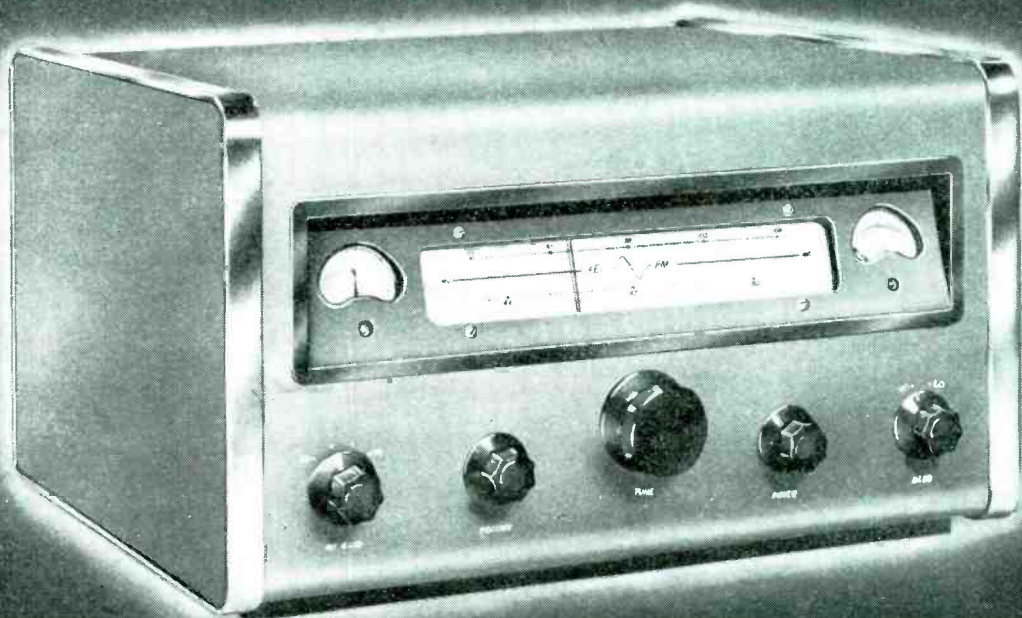

Here is a custom built, top quality instrument—designed and produced by the leading manufacturer of FM transmitters.

This receiver is proving most useful to broadcasters for: monitoring, relaying, qualitative field strength measurements, checking directive antennas, demonstrations and many other professional uses.

Used in combination with a quality reproducer, this instrument will give the discriminating listener the highest performance in FM reception.

Specifications of Model 646 — illustrated above — includes standard receiver, 115 volt A. C. power supply and 10 watt amplifier in a single cabinet:

Frequency Range: 88 to 108 and 44 to 50 megacycles.

Sensitivity: Receiver limits on input circuit noise at any frequency in the 88 to 108 and 44 to 50 megacycle bands. For all input signals of four microvolts or more applied to the input terminals, the receiver output signal to noise ratio in a band from 50 to 15,000 cycles is within three db of the optimum obtainable at the present state of the art where the limiting noise is random.

Frequency Response: Plus or minus 1 db 30 to 15,000 cycles, including de-emphasis of 75 microsecond time constant.

Noise Suppression: Receiver noise is 70 db or more below output of ten watts for any quieting carrier.

Waveform Distortion: Receiver distortion up through the detector is less than 1% for 100% modulation. The ten watt audio amplifier asso-

ciated with the Model 646 Receiver has less than 1.5% distortion at full output for any fundamental from 50 to 7500 cycles.

Image Rejection: Better than 45 db.

I.F. Rejection: Better than 65 db.

Power Supply: 115 volts, 60 cycles, single phase. Consumption 125 watts.

Output: 10 watts, 500 and 8 ohms.

Controls: Tuning, Band change switch, Audio frequency gain, Radio frequency gain, Power switch.

Meters: Signal strength. Tuning indicator.

Dimensions: 19" wide x 16 $\frac{3}{8}$ " deep x 10 $\frac{3}{8}$ " high. Weight: 54 lbs. net.

Net price: \$340 F.O.B. factory — plus tax. Now in production for early delivery.

Other models available include #647 — designed for schools and other applications where a receiver but no audio amplifier is needed. Incorporates receiver chassis and AC power supply.

#648 for mobile use — includes receiver chassis, 6 volt DC power supply combined with 4 watt amplifier. Operates from 6 volt storage battery.

Inquiries for descriptive bulletin or further details will be promptly answered.



RADIO ENGINEERING LABORATORIES, INC.

35-54 36th STREET

LONG ISLAND CITY 1, N. Y.

Step by Step

Engineering

Tooling

Machining

Painting

Electroplating

Assembling

PAUL and BEEKMAN, Inc. performs a complete service in producing metal stampings

You need a lot of things to produce metal stampings efficiently at low cost. Skilled personnel . . . the right presses . . . organized planning . . . you need them all.

And Paul and Beekman, Inc., has them—plus plenty of experience. We make all types of stampings . . . large or small, simple or complex. We make them from mild or stainless steel, aluminum, copper and brass, painted or electroplated if required. We make them fast, at a cost that can help you remain competitive.

Many manufacturers have found it profitable to use our step by step service. Let us tell you how it might be applied in your case. Write for descriptive literature.

PAUL and BEEKMAN, Inc.
Eighteenth & Courtland Sts. Philadelphia, Pa.
Subsidiary of PORTABLE PRODUCTS CORPORATION

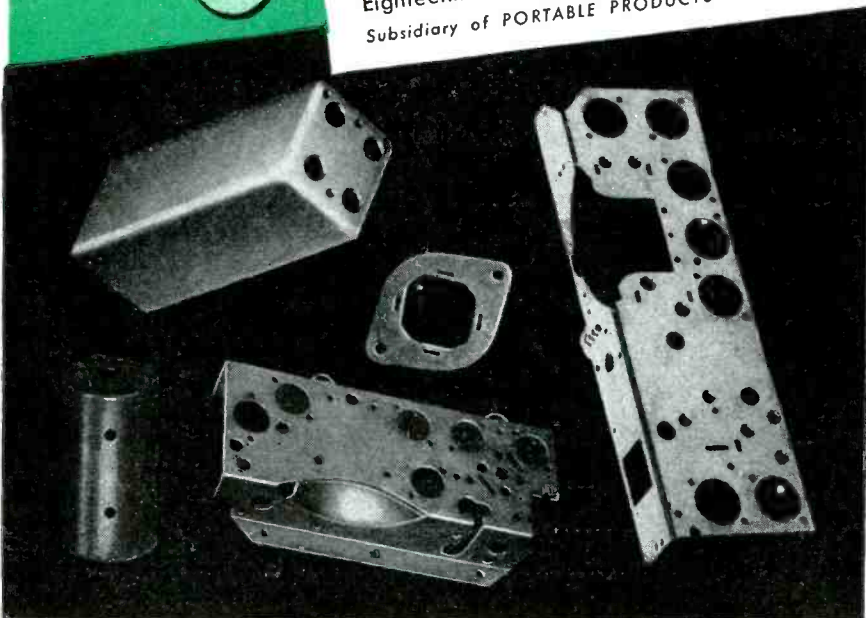

TUBES AT WORK (continued from p 134)

and simply multiplies these ranges mentally by Y/10.

For positions 9, 10, and 11 of the range selector switch, 1,000, 100, and 10 ohms respectively are shunted directly across the test-lead binding posts, and the voltage drop across the particular one of these resistors being used is opposed through phones and vibrator by the calibrated voltage drop across the measuring potentiometer. The instrument then acts as a current meter with a range of 1.0, 10, or 100 ma. The 1.0-volt range (position 8) can also be regarded as a 500- μ a range.

Ranges

The following resistance ranges are obtained for positions 2 through 11 of the range switch respectively: 1,000,000, 400,000, 200,000, 100,000, 20,000, 10,000, 2,000, 1,000, 100, and 10 ohms. The corresponding voltage and current ranges are: 500, 200, 100, 50, 10, 5, and 1 volt; and 1, 10, and 100 ma.

By adding external resistance between binding posts M_1 and M_2 , higher ranges of voltage and resistance can be readily obtained. The 0.1 μ f capacitor together with switch S_1 and pushbutton S_2 , makes it possible to measure quite high resistances provided accurate range multipliers of the same value are available. To make such high resistance measurements, the vibrator is removed from the instrument, and the push button is used as a hand operated interrupter. This gives the capacitor time to charge between successive applications of the push button, and when

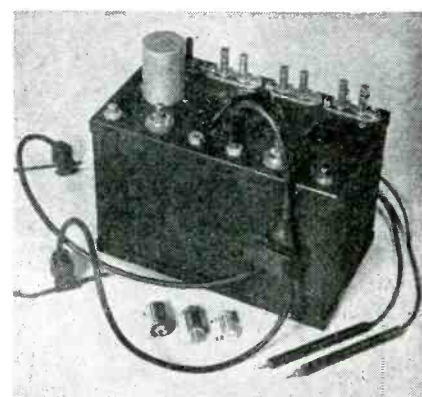

Complete instrument that permits a blind person to measure resistance, voltage, and current

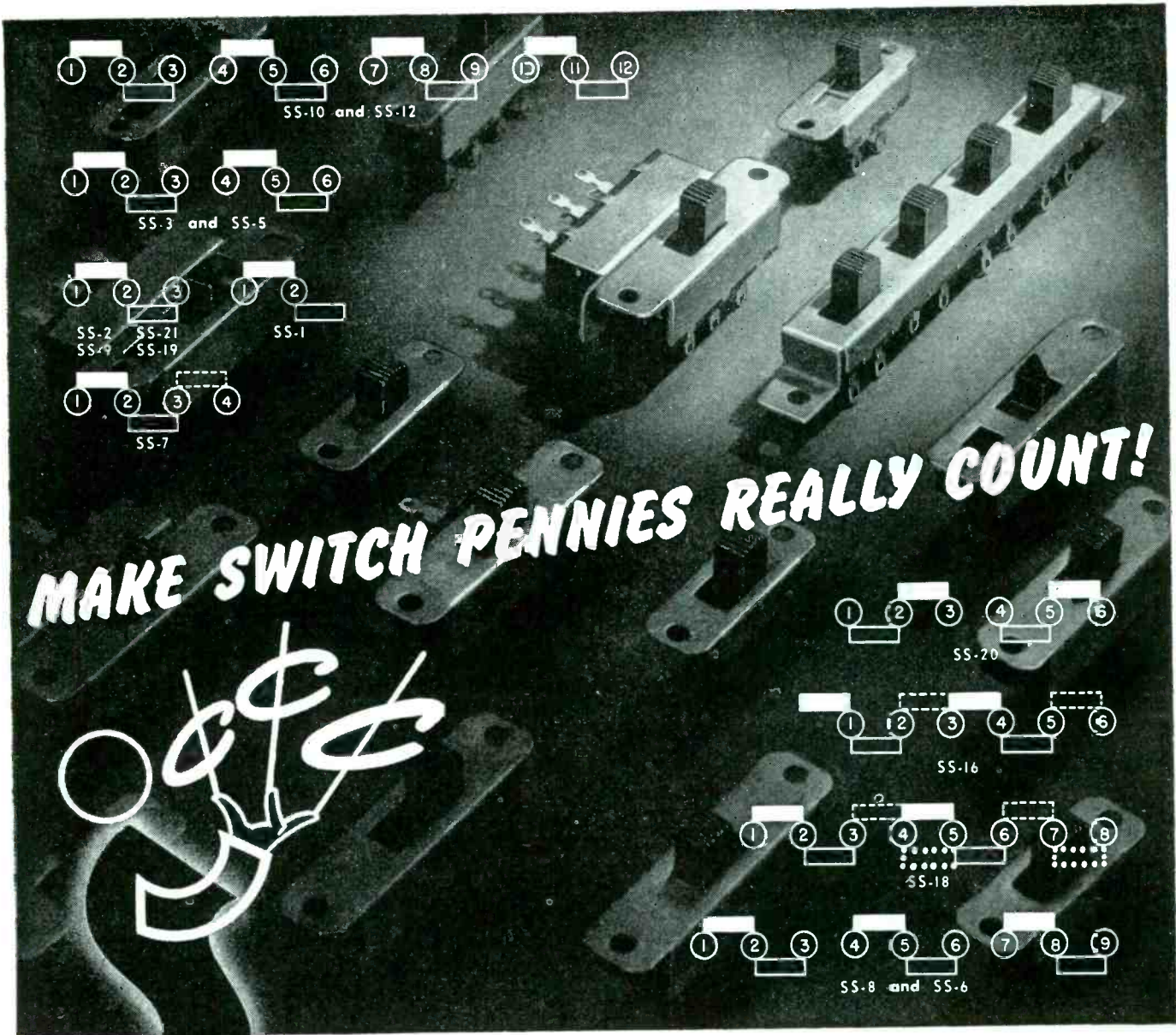

MAKE SWITCH PENNIES REALLY COUNT!

OTHER STACKPOLE PRODUCTS

- FIXED AND VARIABLE RESISTORS
- IRON CORES
- POWER TUBE ANODES
- ELECTRICAL CONTACTS
- CARBON PILE VOLTAGE REGULATOR DISCS
- MICROPHONE CARBONS
- SINTERED ALNICO II
- PERMANENT MAGNETS
- ... and dozens more

CONTACT CODE	
POSITION 1	
POSITION 2	
POSITION 3	
POSITION 4	

1001 Uses for these 16 Handy SLIDE SWITCHES

Name the switch contact arrangement you need! From 1 to 6 poles, up to 4 positions, with or without detent, spring return, covers, or other optional features.

Chances are Stackpole can supply exactly the right switch—promptly and inexpensively. 16 standard slide types,

each designed for good appearance and real dependability, provide a low cost way of modernizing almost any electrical equipment and adding greatly to its sales appeal. Many economical adaptations can be supplied on special order to large quantity users.

Write for Catalog RC-6

STACKPOLE

STACKPOLE CARBON CO. • ST. MARYS, PA.
ELECTRONIC COMPONENTS DIVISION

Need Fastenings?

See **SCOVILL!**

FOR SEMS WASHER SCREW ASSEMBLIES



Washer permanently fastened on, yet free to rotate. Easier, faster driving. No fumbled, lost or forgotten washers. Matching finish on both parts. Easier ordering and balanced inventories.

FOR PHILLIPS RECESSED HEAD SCREWS



Increase assembly speed up to 50%! Cut down injuries to workers with no burrs, no skids. Reduce production costs. Reduce rejects! Improve product appearance! Go modern with Phillips!

FOR CLUTCH-HEAD SCREWS



The latest type recessed-head screw. Screw locks on driver. Can't fall off. No screw-driver slippage. Easy to assemble. Exceptional driver life. Ordinary screw-driver may also be used.

FOR SPECIAL COLD-FORGED FASTENINGS



Scovill is expert in cold-forging unusual special fastenings, such as the one shown. Scovill designing ability, engineering skill, men and machines save money for customers. Consult Scovill!

Look at the fastenings you're now using—and see if they're the best for the job. Get better results—at less cost—with modern fastenings. If you use fastenings in *large quantities*, it will pay you to find out what Scovill can do for you. Fill out and mail the coupon below—*now!*

MAIL COUPON TODAY!

Scovill

QUALITY FASTENERS
FOR
QUANTITY CUSTOMERS

SCOVILL MANUFACTURING COMPANY
WATERVILLE SCREW PRODUCTS DIVISION
WATERVILLE 48, CONN. E-9

Please supply more information on:
 Scovill SEMS Washer Screw Assemblies
 Scovill PHILLIPS Recessed Head Screws
 Scovill CLUTCH HEAD Screws
 Scovill Special Cold-forged Fastenings

NAME _____

COMPANY _____

ADDRESS _____

TUBES AT WORK

(continued)

the latter is depressed, the charge produces a click in the phones. These clicks disappear when the measuring potentiometer is rotated to the point of balance. The vibrator should also be removed during all a-c measurements.

The tolerance for the resistors used is one percent. Experience has shown that a raised scale of small dots in which division points are placed only at intervals of 5 percent of full scale, can easily be read by touch to an accuracy of better than 1 percent. If the distance between division points is between approximately $3/16$ and $3/8$ inch, these dimensions are commensurate with the dimensions of the very sensitive area on the tip of the index finger. Under the worst conditions, readings should not be subject to an error greater than 2 percent of full scale. Usually the errors observed have been less than 1 percent.

Cathode-Coupled Half-Shot Multivibrator

BY ROBERT K. F. SCAL
New York, N. Y.

IN CONNECTION with the construction of synchronization equipment for the Stanford University multi-frequency ionosphere recorder, the author developed a frequency divider which is simple in construction, dependable in operation with either continuous, intermittent series or individual actuating pulses, and which has already proved valuable in several other applications. Due to its original application as a pulse-frequency halver it was referred to as a pulse-halver. However, it is more broadly referred to as a half-shot multivibrator, from the fact that it is de-

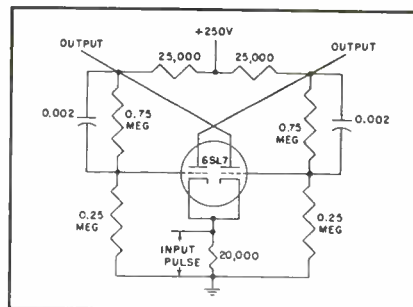

FIG. 1—Circuit of the half-shot multivibrator

This recently completed modern structure, providing more than 32,000 square feet of floor space, is our new home.

Production volume has been considerably increased by the installation of latest equipment for highly specialized operations. Engineering, inspection and testing facilities have been greatly expanded to insure excellence of products with the maximum of efficiency.

These greatly expanded overall plant facilities, plus the recognized dependability of S C A products, make it possible for us to offer the most complete line of Selenium Rectifiers and self-generating Photoelectric Cells.

FACILITIES

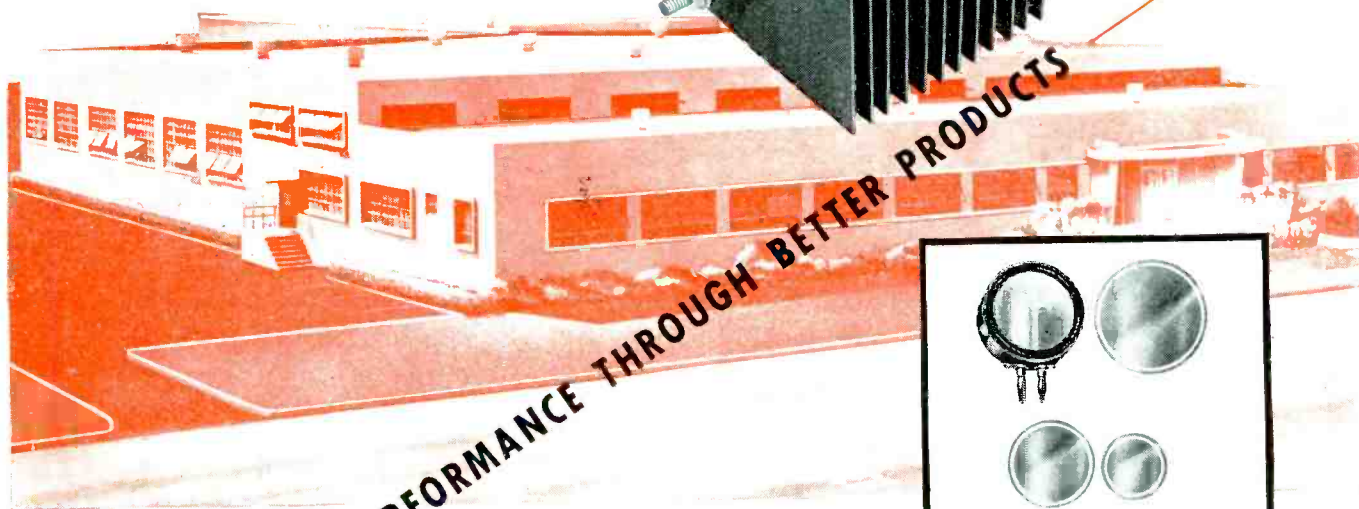
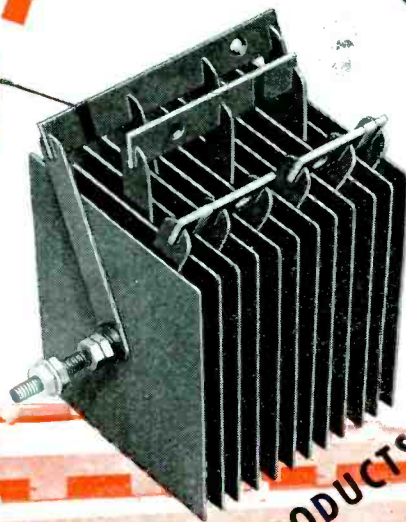
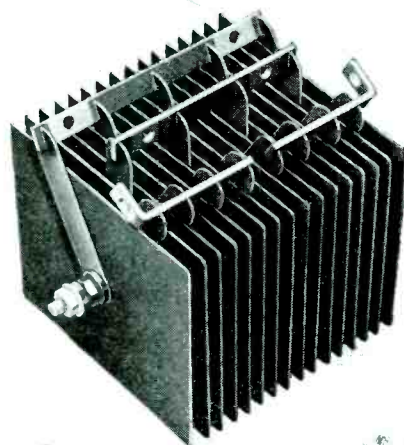
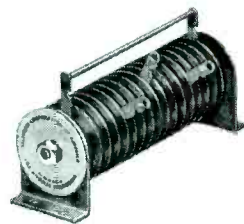

BETTER PERFORMANCE THROUGH BETTER PRODUCTS

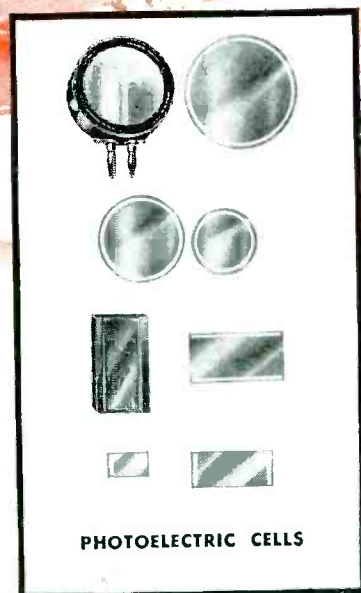

PHOTOELECTRIC CELLS



SELENIUM CORPORATION OF AMERICA

Affiliate of **VICKERS** Incorporated

2160 EAST IMPERIAL HIGHWAY • EL SEGUNDO, CALIFORNIA
 EXPORT: Frazer & Hansen, Ltd., 301 Clay St., San Francisco 11, Calif.
 Canada: Powertronic Equipment Ltd., 494 King St., E. Toronto 2, Canada

47-1

THE BALLANTINE ELECTRONIC VOLTMETER,



since 1935
the only VOLTMETER
featuring a simplified
LOGARITHMIC SCALE

DECADE AMPLIFIER AND MULTIPLIERS

MODEL 300
ELECTRONIC
VOLTMETER

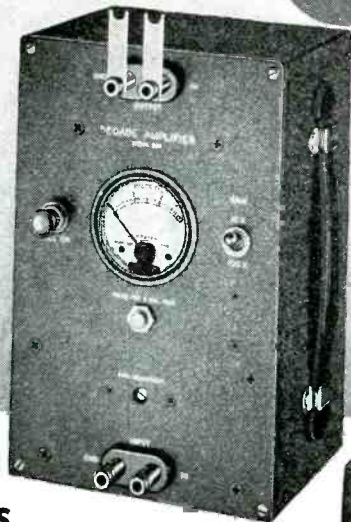

MODEL 220
DECADE
AMPLIFIER



MODEL 402
MULTIPLIER

**10 MICROVOLTS
to 10,000 VOLTS**

ONE BILLION TO ONE—This enormous range of AC voltages—is easily covered by the Model 300 Voltmeter, Model 220 Decade Amplifier and Model 402 Multipliers illustrated above. The accuracy is 2% at any point on the meter scale, over a frequency range of 10 cycles to 150 kilocycles. The Model 300 Voltmeter (AC operated) reads from .001 volt to 100 volts, the Model 220 Amplifier (battery operated) supplies accurately standardized gains of 10x and 100x and the Model 402 Multipliers extend the range of the voltmeter to 1,000 and 10,000 volts full scale.

Descriptive Bulletin No. 10 Available

BALLANTINE LABORATORIES, INC.
BOONTON, NEW JERSEY, U. S. A.

veloped from the basic Eccles-Jordan multivibrator circuit and that one-half an output cycle is obtained for each complete input cycle.

The circuit developed by the author is simple in construction and does not require a large negative voltage from a separate power supply. It operates with any plate supply voltage from 125 to 325 volts and the cathode potential will not exceed eighty volts with respect to ground or heater.

Uses

One application of this circuit is for frequency division, where any frequency (from practically zero on up into the lower r-f range) may be divided by any power of two simply by using the required number of stages in series, the output of each stage being applied to the input of the next through a simple R-C differentiating circuit. By means of a single-pole selector switch a versatile circuit may be constructed to give either rectangular waves or pulses, by connecting the taps either ahead of or following the differentiators, or both, at a number of different frequencies.

The half-shot multivibrator may also be employed as an electronic switch, which operates each of two external circuits by means of the output voltage of either or both of the plates. For this purpose the circuit supplies two rectangular waves 180 degrees out of phase.

Circuit Operation

The basic circuit is shown in Fig. 1. This circuit is symmetrical and is stable with either triode conducting, and the other one cut off. This means that it is possible for a single input pulse to actuate it for one-half cycle.

As this circuit is activated only by a negative pulse whose magnitude is limited to a reasonable value, it may be triggered by a differentiated rectangular wave, each cycle of which gives a single operating pulse and thus one-half of an output rectangular wave cycle. In this way, two input rectangular wave cycles (pulses) give a single output rectangular wave cycle. If alternate negative input pulses are equally spaced, the output will be a square wave, but by controlling the spacing of the input pulses, rec-

FIBROUS GLASS TUBING*

**IF IT'S TURBO—
IT SAFEGUARDS!**

...a special insulator for
the really "tough" jobs!



* **TUREO Fibrous Glass Tubing in four grades—**
Single Saturated, 1200 V;
Double Dip, 2000 V;
Plate Strength, 3500 V;
Magne Grade, 7000 V.

ASK THE DESIGNER! He knows that glass stands near the top of the list of dielectrics which offer greatest resistance to heat, corrosion, flame, oxidation, rot and other deteriorants. Woven of soft, flexible fibrous glass yarn, **TURBO Glass Tubing** is inherently an excellent insulator. Combined with **TUREO** varnish impregnants in the manufacturing process, it becomes an ideal material for exceptionally difficult applications. Below are listed some of the other quality **TURBO** insulating materials extensively used in industry:

Saturated Sleeving

An all purpose insulation for any but the higher dielectric ranges. Varnish impregnated cotton yarns. Flexible, strong, resistant to acids and oils. Good moisture and flame resistance. Dielectric breakdown—1200 V., per ASTM test.

Plastic Insulated Wire

Number 18 and finer stranded and solid conductor with a seamless extruded plastic insulation. Surpassing dielectric properties. Resistant to oils, organic solvents, acids, alkalis and oxidation. Minimum shrinkage and burning effects in soldering and potting.

Varnished Tubing

A superior braided cotton insulation featuring saturation impregnation of flexible varnishes. Strong, flexible, non-peeling, non-cracking, moisture, oil, acid and flame resistant. Dielectric breakdown ASTM test—Magne grade—7000 V., Radio grade—4000 V.

Mica & Mica Products

All forms—plate, block segments, films. Rigid control in all stages—grading selection, fabrication and testing insures uniformity and quality in finished products. Meets all tests involving physical and electrical stability. Specific problem-collaboration is invited.

TURBO

WILLIAM BRAND & COMPANY
276 FOURTH AVE., NEW YORK 10, N. Y. - 325 W. HURON ST., CHICAGO 10, ILL.

Pick



AUTOMATIC ELECTRIC TEMPERATURE CONTROLS

for
**Accuracy—Long Life
Dependability**

Efficient design and rugged construction make "Diamond H" electric temperature controls your best choice for domestic and commercial cooking, water heating and industrial applications requiring accurate thermostatic control of electrical heating circuits.

Hot water and oven type thermostats with current ratings to 35 A., 230 V., A.C. Operating temperatures to 550° F.

Hydraulic, immersion type for water and other liquid applications. Snap action. Silver contacts. 30 A., 115 V.; 25 A., 230 V.; A.C. only.

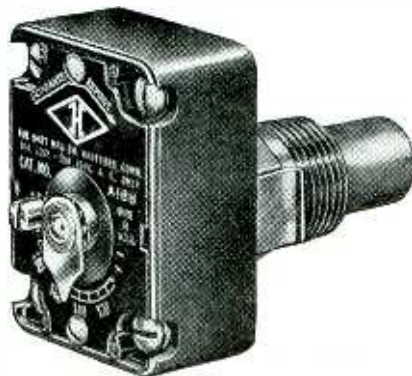

"Diamond H" controls will be engineered to your requirements. Ask about "Diamond H" switches, pilot lights or convenience outlets.

THE HART MANUFACTURING COMPANY
202 BARTHOLOMEW AVENUE, HARTFORD, CONN.

TUBES AT WORK

(continued)

tangular waves of various proportions may be obtained from the output.

Action With Positive Pulse

In either stable condition, one triode is conducting and the other is cut-off. If a positive pulse is applied to the cathodes the conducting tube will tend to conduct less current. However, this tendency is counteracted by the fact that any decrease in this grid-cathode potential causes less grid current to flow, and the drop in the cathode, the grid-to-plate, and the plate-to-plate supply resistors causes the grid voltage to return to nearly zero with respect to the cathode.

As the cathode and grid go positive as a unit, the plate does likewise, and due to the coupling capacitor the grid of the cut-off tube is forced to go more positive. However, the grid-cathode potential of the cut-off tube remains about the same and this tube is held beyond cut-off even with a positive pulse on the cathode. Therefore the circuit is not actuated by positive pulses as long as the coupling capacitor's discharge time constant is large compared to the pulse width, and the pulse is of reasonable magnitude.

With a positive input pulse, a very small positive pip is visible on the plate waveform during both the cutoff and conducting portions, since the drop in grid current of the conducting tube also causes the latter's plate voltage to rise. These pips are visible only with large vertical amplification of the plate voltage waveforms.

Effect of Negative Pulse

If a negative pulse is applied to the cathodes, the tube that is conducting will continue to do so, but the other tube will start to conduct, causing its plate voltage to be decreased. Due to the coupling capacitor, the grid potential of the conducting tube will be slightly decreased also, so that it starts to cut off, causing its plate voltage to rise, which in turn raises the grid-cathode potential of the formerly conducting tube still more through the other coupling capacitor.

This action is cumulative and instantaneous, amounting to a complete switching of tubes. Another



AMAZINGLY QUIET - **POWERFUL** - *Efficient*

Motor rumble—the bugaboo of all magnetic recorders and pick-ups—now reaches a new vanishing point in a revolutionary new motor developed by the Russell Electric Company.

Known as the Type 300 motor (Pat. No. 2071224), it combines high starting torque with high efficiency and flexibility. A 4-pole motor, it has a very low external field because of the large

amount of iron in its core. Unmatched in design!

Lasting quietness is assured by a rabbeted stator that keeps rotor accurately centered and aligned—plus a precision dynamic balance.

Smooth, cool-running operation is assured by an efficient lubricating system and *two* cooling fans.

Prompt delivery now offered on Type 300 motor. Phone, write or wire for complete information.

340 West Huron Street • **RUSSELL ELECTRIC COMPANY** • Chicago, Illinois

USERS SAY:

"WRINKLE!" FOR LOWEST COST FOR DURABILITY FOR SALES APPEAL

Testimonials:

● Wrinkle is "long wearing, does not mar easily . . . inexpensive to apply . . . effectively covers surface defects."

Bausch & Lomb Optical Co.

● Wrinkle "stands up under a wide range of atmospheric conditions to which aircraft equipment is necessarily subjected."

The A. W. Hayden Company

● "Wrinkle will stand more abuse in handling of the factory, in shipping, and at the point of installation."

Airtemp Division,
Chrysler Corp.

SYLVANIA DILATOMETER

—WRINKLE FINISH

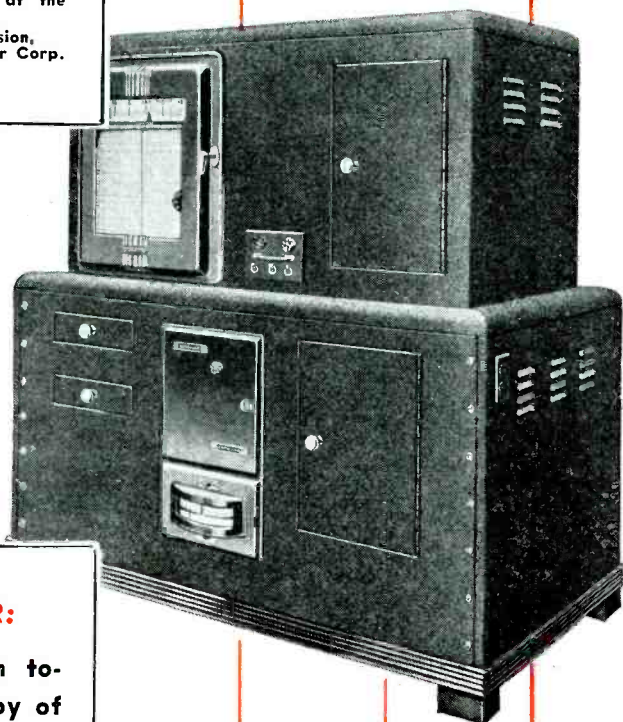

FREE OFFER:

Mail this coupon today for your copy of "Hour Saver — Dollar Maker." It gives complete information on Wrinkle finish applications—illustrated with photos from production.

New Wrinkle, INC.

137 N. PERRY ST., DAYTON 2, OHIO

NEW WRINKLE, INC., 137 NORTH PERRY STREET, DAYTON 2, OHIO
Please send me immediately your illustrated booklet "Hour Saver . . . Dollar Maker" — and a list of Wrinkle manufacturers and distributors.

Name _____ EL
Title _____
Company _____
Street _____
City _____ Zone _____ State _____

TUBES AT WORK

(continued)

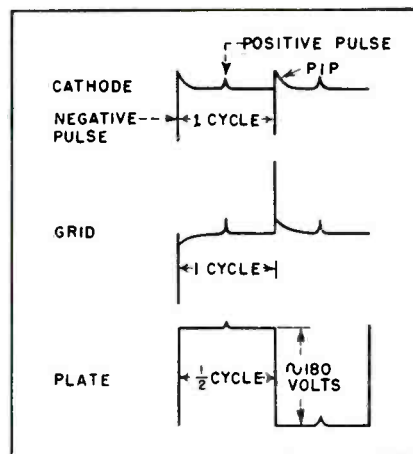

FIG. 2—Waveforms at elements of one triode. The pip at the cathode is due to charging effects of an isolating capacitor in the input pulse circuit

negative pulse applied to the cathodes will switch the tubes back to their original condition, in a similar manner, and repeated pulses result in rectangular waveforms on each plate of one-half the frequency of the negative triggering pulse. The output of either or both plates may be used, as desired.

The resistance values are calculated with the aid of the tube characteristic curves to give a steady-state condition which can be easily switched by the available cathode pulse so that when one tube has zero grid-cathode potential the other will be held just beyond cut-off.

The limitations on the operating frequency range are due to the charging and discharging of the coupling capacitors. Above the upper frequency limit the circuit acts like a conventional frequency divider whose operation depends on the charging rate of a capacitor, and thus its factor of frequency division is a function of the input pulse width and R-C time constants.

For normal operation, the size of the coupling capacitors is not critical. The capacitance must be great enough so that little charging and discharging can take place while the pulse is applied to the cathodes. Otherwise the circuit becomes unstable and does not know which way to go because each triode will be conducting an equal amount of current and it will be a matter of chance which tube gains control and causes the other tube to be cut off. The capacitors must be small enough so that they can

Only $\frac{1}{16}$ " IN DIAMETER...

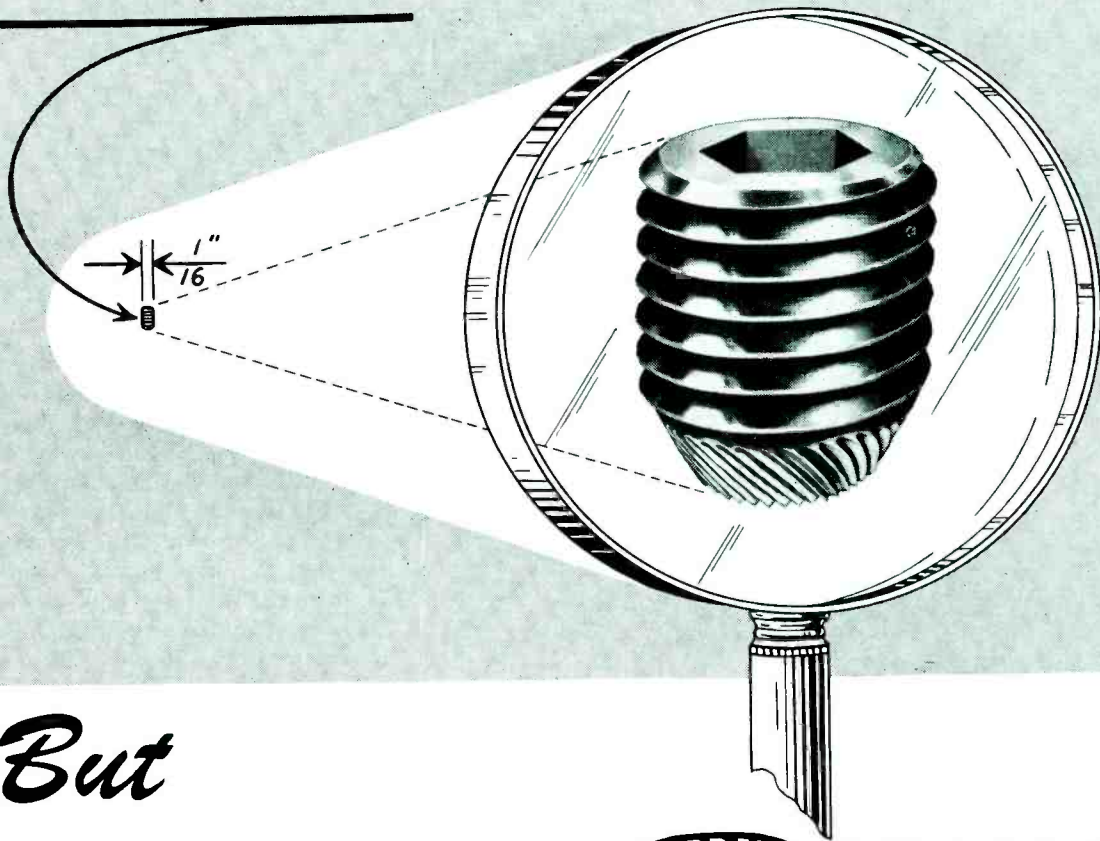

But

A FULL-FLEDGED UNBRAKO SELF-LOCKER

Reg. U. S. Pat. Off.

...KNURLED CUP POINT, HOLLOW SOCKET HEAD, AND ALL

"Unbrako" and "Hallowell" Products are sold entirely through Industrial Distributors.

Knurling of Socket Screws originated with "Unbrako" in 1934.

Yes, regardless of size, the knurled cup points of "Unbrako" Socket Set Screws dig-in and "stay dug" — even when subjected to the most chattering vibration. Yet, they can be easily backed-out with a wrench and used over again and again. Write for your copy of the "Unbrako" Catalog of Socket Screw Products.



The Knurled threads make this screw a Self-Locker, too, for Flat, Cone, Oval, One-Half and Full Dog Points.

Pat'd & Pats. Pend.



The Knurled head of this "Unbrako" provides a slip- and fumble-proof grip, though the fingers and head be ever so oily, therefore, it can be screwed-in faster and farther before it becomes necessary to use a wrench.

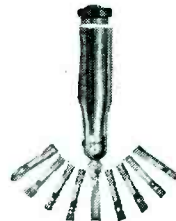

You can't screw socket screws in or out without a hex-socket wrench so why not get our No. 25 or No. 50 "Hallowell" Hollow Handle Key Kit which contains most all hex bits.

Kits: Pats. Pend.

OVER 44 YEARS IN BUSINESS

STANDARD PRESSED STEEL CO.

JENKINTOWN, PENNA., BOX 596 • BRANCHES: BOSTON • CHICAGO • DETROIT • INDIANAPOLIS • ST. LOUIS • SAN FRANCISCO

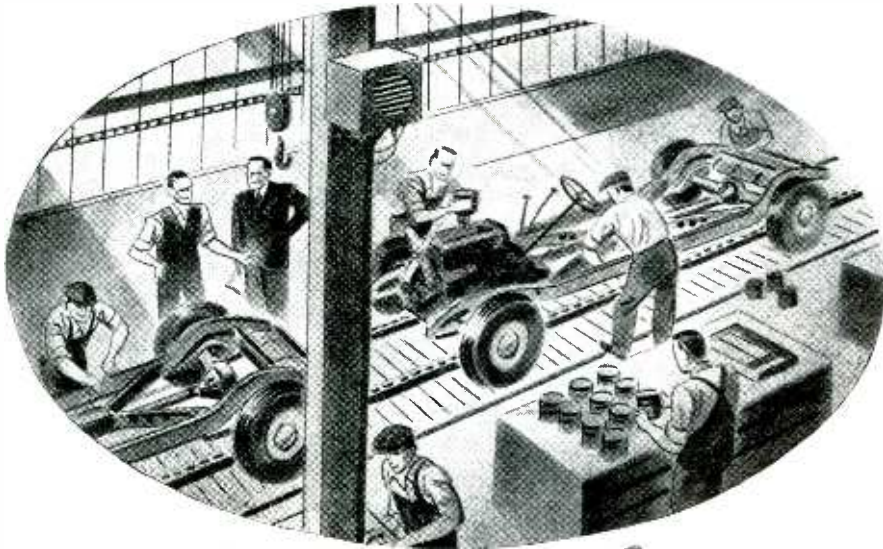

Recorded Music Means Increased Profits!

Remember how manufacturers learned that in the war? Music was "piped" into almost every production line in America! Today when keeping employees happy and production high is so important, manufacturers want continuous music. Magnetic wire recording is the answer. And smart wire recorder designers look first to Brush for the best in magnetic recording equipment. Here's why—

Brush Plated Wire

- ✓ Constant plating thickness assures uniform signal
- ✓ Correct balance of magnetic properties assures good frequency response and high level
- ✓ Excellent surface finish assures low noise and minimum wear
- ✓ Corrosion resistant
- ✓ Easy to handle—ductile—can be knotted

Brush Wire Recording Heads

Of principal interest are their excellent electrical characteristics, extreme simplicity of design to avoid trouble, and the "hum-bucking" characteristics, which reduce the effect of extraneous magnetic fields. When required, the head cartridge alone (pole piece and coil unit) may be supplied for incorporation into manufacturers' own head structure.

These latest developments in magnetic recording equipment can now be obtained for radio combinations and other uses. Brush engineers are ready to assist you in your particular use of magnetic recording components.

THE BRUSH DEVELOPMENT CO.
 3405 PERKINS AVENUE  CLEVELAND 14, OHIO

charge and discharge sufficiently between pulses to be prepared for the next pulse. Fig. 2 shows the waveforms of the circuit when actuated by a 60-cycle input pulse.

Tubes Critical

Either a high- μ (6SL7) or a medium- μ (6SN7) twin triode may be used. The wider the frequency range over which a particular circuit is to operate, the more constant the plate supply voltage must be, and for best results in such applications a regulated power supply is indicated.

Particular tubes of the same type will not always operate in this circuit, and sometimes it is not possible to obtain operation by adjustment of the resistor network alone. However, the circuit can always be made to work by connecting small external capacitances across the tube elements by trial and error. Adjustment of circuit resistance or external capacitance to make a particular tube operate is not recommended. It has been found that when a circuit has once been made to work properly, and no external capacitance is present, approximately 60 percent of the dual triodes selected at random will operate. The use of individual triodes may be preferred to facilitate obtaining properly matched pairs of triodes.

The very large rectangular wave output is capable of producing so-called r-f burns, even with a repetition frequency as low as 15 cps.

C-R Tube on Power Lines

McGraw-Hill World News

USE of the cathode-ray tube as a power-frequency synchroscope has been successfully developed and extensively tested by the State Electricity Commission of Victoria, Australia.

To preserve continuity of power supply, synchronizing facilities are required at each switching station, so that reconnections can be made at points of circuit interruption without de-energizing sections of line back to the generating station.

Dispensing with the large number of potential transformers which must be provided for connection on

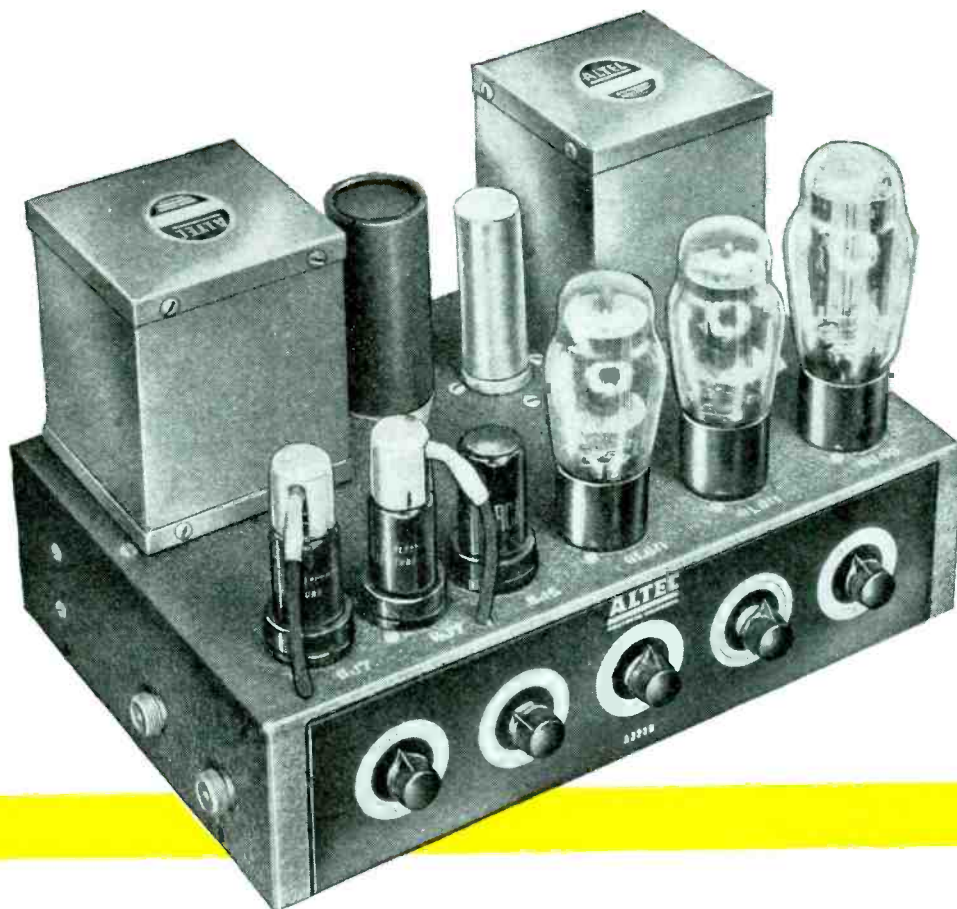

Capable of realizing the full resources of the new professional FM tuners

... and linking their superior performance
to the industry's first-choice speaker*

The final link in the chain of high-quality reproduction has now been forged: a power amplifier which brings out the final degree of excellence of performance of the new professional-quality tuners, and of the two-way multicellular speaker which has become the standard of the broadcasting, recording, and motion picture industries, the Altec Lansing Duplex speaker.

Salient characteristics of the New Altec Lansing A-323B Amplifier are:

1. Flat frequency response—within 1 db from 20 cycles to 20,000 cycles.
2. Full 15 watt power output within 1db from 35 cycles to 12,000 cycles.
3. Two inputs. One low gain from radio tuner, and one high gain with built-in equalization to operate direct from the new General Electric Variable Reluctance or the new Pickering Cartridge Pickup.
4. For record reproduction, stepped low pass filter which gives sharp cut-off of noise frequencies yet allows full reproduction of useable high frequencies.
5. Adjustable base boost.
6. Hum balancing potentiometer to eliminate the necessity of careful selecting of tubes for quiet operation.

The Altec Lansing A-323B Amplifier was designed with a particular view to its use in high-quality music reproduction systems in which the electrical elements—tuner, amplifier, record player, and speaker—are either wholly concealed in the in-

terior structure of the room, or partly concealed in furniture already in harmony with the interior scheme.

The noteworthy trend, among fastidious, musical-minded home lovers, toward built-in music systems which eliminate non-functional radio "furniture"—and thus eliminate the inevitable problem of assimilating "big sets" into modern decorator-influenced interiors, is becoming increasingly apparent; this trend highlights the importance of the new Altec Lansing amplifier and the Duplex multicellular speaker in the advanced planning in the FM field.

*The Altec Lansing Duplex Loudspeaker



The Altec Lansing loudspeaker is the only speaker which in actual performance has been found capable of reproducing the full frequency and dynamic ranges, and without distortion, all the characteristics of sound of which the frequency modulation method of radio transmission is capable. The high efficiency, and the resultant damping, causes the Altec Lansing Duplex loudspeaker to follow accurately every variation in the signal wave form, without contributing the spurious sounds that result from intermodulation and poor transit characteristics common to ordinary speakers.

ALTEC
LANSING CORPORATION

250 W. 57th St., N.Y. 19, N.Y.

1161 N. Vine St., Hollywood 38, Calif.

which acts as the outer conductor of the coaxial coil. Since the transmitted energy is of much higher density around the inner conductor, the area in the small hole of the metal part will heat at a much faster rate than the rest of the part.

The part can be drop or spray quenched for hardening purposes, as for example in the heat treating of dies, or merely removed and allowed to cool, in other applications such as brazing, soldering, or annealing. Many mechanical arrangements are possible for feeding work pieces into the jig. For example, the one illustrated might use a movable bottom plate that would contact the outer and inner conductor when the work is inserted. Shutoff of the flow of coolant could be controlled by a valve during loading, or continuous flow could be permitted in some applications.

Compact Power Supply for High Current

BY LAWRENCE FLEMING
Naval Ordnance Laboratory
Washington, D. C.

THE POWER SUPPLY shown in Fig. 1 delivers 235 volts d-c at one ampere and permits an unusually large ratio of power output to physical size by employing a three-phase rectifier circuit!

This unit is a convenient source of plate power for large numbers of receiving tubes in multichannel oscillograph amplifiers and similar installations. The single-phase sup-

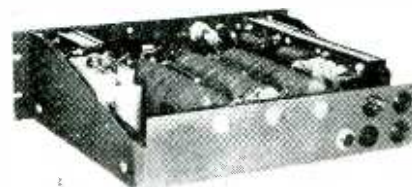
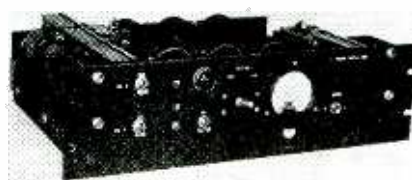

FIG. 1—Front and rear views of the high-current power supply



AUTOMATICALLY PLAYS TWELVE 10" OR TEN 12" RECORDS

CUTS RECORDS UP TO 10"

**GI-RC130
Combination Record-
Changer Recorder**

ONE SIMPLE LEVER ADJUSTMENT

Smooth Power COMBINATION RECORD-CHANGER • RECORDER

Your customers will like the simplicity and fine performance of this unique combination *Smooth Power* unit.

They'll enjoy the ease of operation with one simple lever for quick changing from one size record to another, to remove records or to set for manual operation and recording. They'll appreciate the smoothness and quietness of the record-changer. They'll admire the brown iridescent finish and streamline plastic trim on self-indicating "Reproducer" and "Recorder" arms.

And, of course, they'll value the quiet, vibration-free operation of the *Smooth Power* Motor.

Send for details. Ask us for complete information on this popularity-building combination that can add new sales appeal to your products . . . and on the complete line of *Smooth Power* Phonomotors and Recorders.



**GI-RM4 Rim Drive, Heavy-Duty
Electric Recording Motor**



**GI-R9D Dual-Speed, Home
Recording and Phonograph
Assembly**



**LX Rim Drive, Constant-Speed
Electric Phonograph Motor**

THE GENERAL INDUSTRIES CO.
DEPT. ME • ELYRIA, OHIO

ROUND

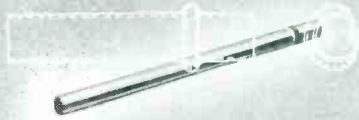

MAXIMUM OD: .100"

Cathode shown—.100" OD x 36 mm long—single beaded.



MINIMUM OD: .040"

Cathode shown—.040" OD x 27 mm long—single beaded.



PLAIN

(without bead or emboss)

Cathode shown—.081" OD x 25 mm long—no bead.

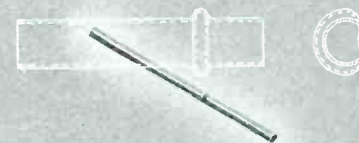

SINGLE BEADING (any position, .040" min. from end)

Cathode shown—.045" OD x 28 mm long—beaded 10.25 mm from one end.



DOUBLE BEADING (same distance from each end)

Cathode shown—.045" OD x 28.5 mm long, beaded .118" from each end.



DOUBLE BEADING (different distances from each end)

Cathode shown—.040" OD x 29.5 mm long, double beaded .039" from one end, distance between beads .699"

ROUND



MINIMUM LENGTH (Round) — 11.5 mm

MAXIMUM LENGTH (Round) — 42 mm

Cathode shown—.045" OD x 11.5 mm long, single beaded.

FLAT OVAL



BEADING ON MAJOR ONLY

Cathode shown—.035" x .060" OD x 29 mm long—single bead on two sides only (major).



BEADING ON BOTH MAJOR AND MINOR

Cathode shown—.045" x .155" OD x 35 mm long—single beaded on three sides—2 on minor and 1 on major.



BEADING ON MINOR ONLY

Cathode shown—.034" x .084" OD x 28.5 mm long—beaded on minor only.



DOUBLE BEADING

Cathode shown—.060" x .124" OD x 30 mm long—double beaded on major only.



MINIMUM LENGTH (OVAL) — 11.5 mm

MAXIMUM LENGTH (OVAL) — 42 mm

Cathode shown—.034" x .084" x 42 mm long—beaded one end on major only.

REFERENCE DATA on All Types of SUPERIOR LOCKSEAM* CATHODE SLEEVES

ROUND AND OVAL—

Plain or Beaded (horizontal & vertical)
Showing maximum and minimum dimensions, bead position, etc.

BASIC DIMENSIONAL DATA

Maximum OD — .100"

Minimum OD — .040"

Minimum length — 11.5 mm

Maximum length — 42 mm

STANDARD WALL THICKNESSES:

.0021" ± .0001"

.0025" ± .0001"

BEAD LOCATION: .040" min.

BEAD DIAMETER: Depends on OD.
Write for Spec. EM-2

BEAD WIDTH: .017" + .003"
— .002"

For tolerance data write for Specification EM-2.

For information on cathode materials write for Data Memo #5.

*Superior Tube Company Patents

VERTICALLY EMBOSSED



This new Lockseam Cathode has wide acceptance for use in certain types of special radio tubes.

Cathode shown—.045" OD x 26.5 mm long—vertically beaded.

THE BIGGER NAME IN SMALL TUBING
Superior
SUPERIOR TUBE COMPANY
ELECTRONICS DIVISION

2500 Germantown Ave. • Norristown, Pennsylvania

IT'S DONE WITH

Mirrors ...

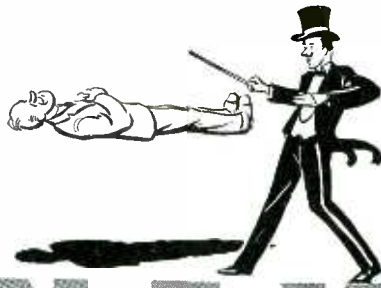

KINNEY VACUUM PUMPS

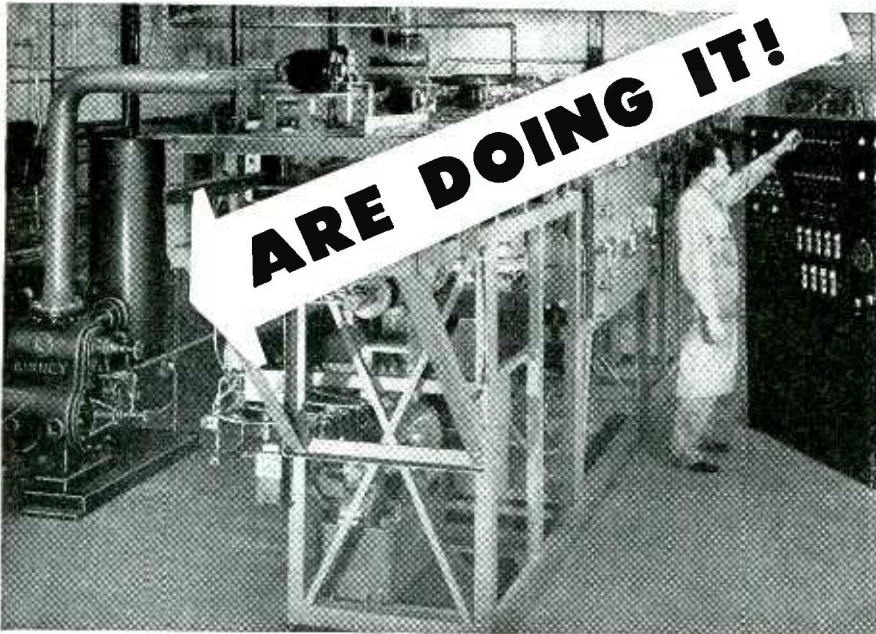

ARE DOING IT!

Coating of front surface mirrors—another wonder product of low pressure processing—is done automatically in this National Research Corporation installation using a KINNEY Vacuum Pump. The KINNEY Single Stage Vacuum Pumps, used in conjunction with diffusion pumps, maintain the low absolute pressures essential for this high vacuum evaporation process. In all parts of the world the uses of KINNEY Pumps are countless—from dehydrating foods to producing penicillin; from exhausting lamps and tubes to sintering alloy metals. Wherever low absolute pressures must be created and maintained, KINNEY Pumps are giving reliable service. KINNEY Single Stage Pumps, available in 8 sizes with displacements of 13 to 702 cu. ft. per min., maintain low absolute pressures to 10 microns; Compound Pumps in 2 sizes, 15 and 46 cu. ft. per min., maintain low pressures to 0.5 micron.

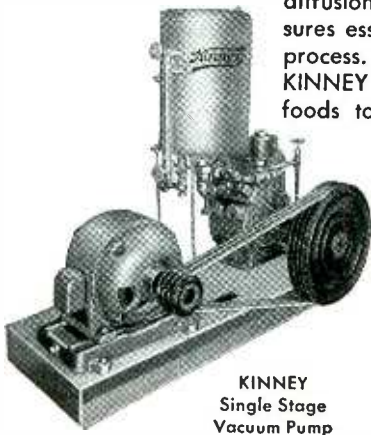

KINNEY
Single Stage
Vacuum Pump

Ask for Catalog V45

KINNEY MANUFACTURING COMPANY

3565 WASHINGTON ST., BOSTON 30, MASS.

NEW YORK • CHICAGO • PHILADELPHIA • LOS ANGELES • SAN FRANCISCO

FOREIGN REPRESENTATIVES

General Engineering Co. (Radcliffe) Ltd., Station Works, Bury Road, Radcliffe, Lancashire, England
Horrocks, Roxburgh Pty., Ltd., Melbourne, C. I. Australia
W. S. Thomas & Taylor Pty., Ltd., Johannesburg, Union of South Africa

WE ALSO MANUFACTURE LIQUID PUMPS, CLUTCHES AND BITUMINOUS DISTRIBUTORS

TUBES AT WORK

(continued)

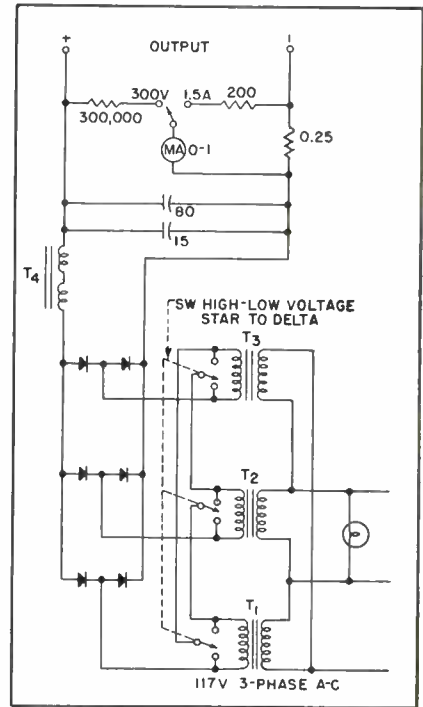

FIG. 2—The selenium rectifiers are Federal 5D16AV1. Choke T_4 is an isolation transformer, Stancor P-6160, with primary and secondary in series. The other transformers are the same type, used conventionally

ply which would ordinarily be considered for such applications would not only be much larger but would require special transformers and chokes.

Ripple output of the unit at full load is approximately 20 millivolts at 360 cycles. Filtering is not difficult because the three-phase full-wave rectifier circuit employed produces an output before filtering which contains only 4.2 percent ripple at 360 cycles.

A switch is arranged to connect the secondaries of the three transformers in either star or delta connection. The former connection gives 235 volts at full load, the latter 120 volts.

If the unit is to be operated continuously, adequate provision must be made for ventilation of the selenium rectifier stacks, since load-carrying capacity of the stacks is primarily limited by temperature.

REFERENCE

(1) Polyphase Rectification, *Proc. I.R.E.*, 19, Jan. 1931, p 78

Hardening Shear Blades

LESS THAN two seconds is required to harden shear blades by induction heating to a higher degree than

AUDIO TRANSFORMERS for [UNIFORM RESPONSE LOW DISTORTION IN 3 FREQUENCY RANGES

*Write for Catalog
showing complete
new stock line*

Full Frequency Range

30 to 15,000 Cycles, provides uniform response over this entire band with $\pm 1/2$ db up to 10 watts of audio power, within ± 1 db over 10 watts. Standard RMA impedances. Hum balancing coil structures and nickel alloy shielding. Included are Input, Output, Driver, and Modulation Transformers; Modulation Reactors. Sealed in Steel construction, stud mounting, with pin-type terminals.

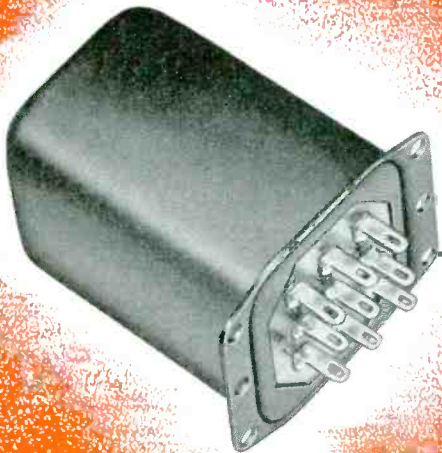
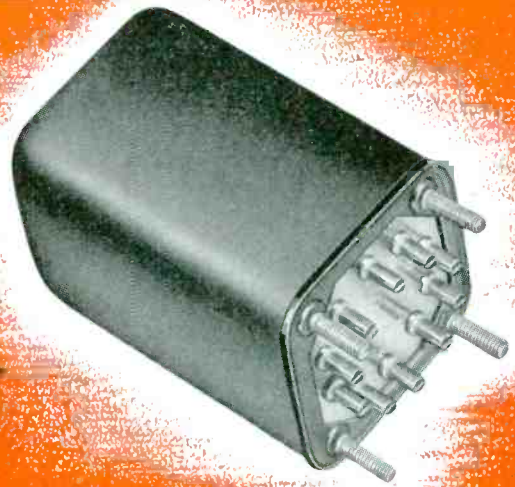

Public Address Range

50 to 10,000 Cycles, frequency response within $\pm 1/2$ db up to 10 watts of power, within ± 1 db over 10 watts, throughout this range. Secondary impedances match 600 and 150-ohm lines, 16, 8 and 4-ohm reproducing systems. Listed are Driver and Output Transformers. Sealed in Steel construction, flange mounting, with solder lugs or wire leads.

Communications Range

200 to 3,500 Cycles, affords response with variations not exceeding ± 1 db over the range of voice frequencies. For use with 600 or 150-ohm lines. Input, Output, Driver and Modulation Transformers offered. Sealed in Steel construction, flange mounting, with wire leads or solder lugs.

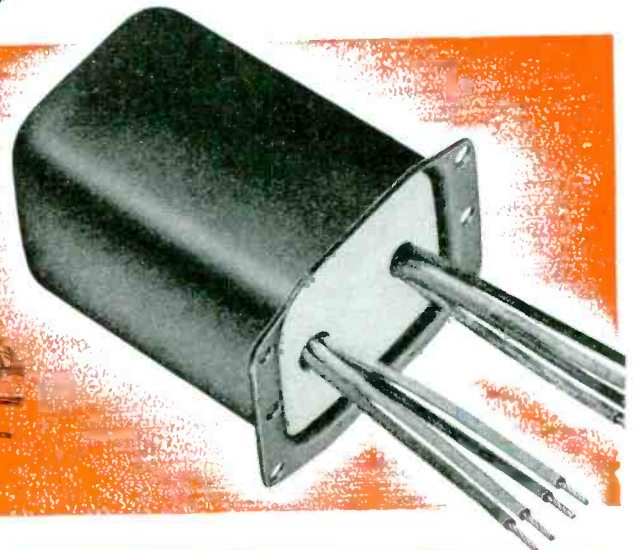

CHICAGO TRANSFORMER

DIVISION OF ESSEX WIRE CORPORATION

3501 ADDISON STREET • CHICAGO 18, ILLINOIS

AMERICA'S LEADING
MANUFACTURERS SPECIFY

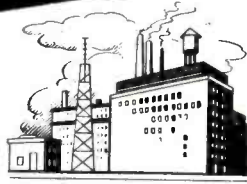

AMRECON

Telephone Type

RELAYS

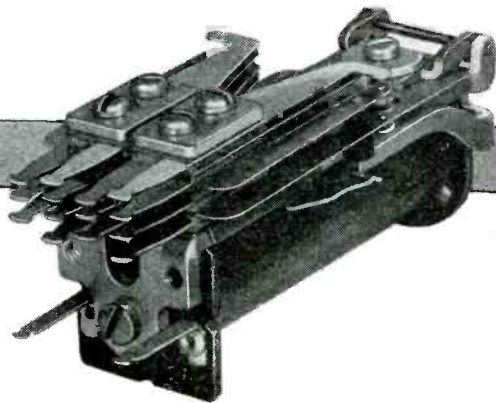

Amrecon's technical knowledge of practical relay application simplifies your own control requirement problems. Our new modern plant is now in full operation and we can offer you prompt delivery and even greater service.

Write for our informative illustrated Bulletin listing our many products, describing the scope of our manufacturing facilities, and the wide extent of our services. Your inquiry will receive prompt attention.



ENGINEERING "KNOW-HOW"

Offices in principal cities

American Relay & Controls, Inc.

2555 DIVERSEY AVE. • CHICAGO 47, ILL.

TUBES AT WORK

(continued)



Shear blades are hardened in this jig of the 20-kw induction-heating generator

government specifications for this hardness, Rockwell C55 to 60. Such shears of definitely better quality, with blades electronically hardened on the cutting edges, are now being produced by Acme Shear Co. of Bridgeport, Conn. Blades are a solid forging of carbon steel, edge-hardened to the high limit, and the back of the blade left malleable to prevent breaking.

In bending tests, the electronic heat-treated blade with the hardest cutting edge withstood twice the bending pressure that fractured blades made by other methods.

Further savings accomplished as a result of the use of high frequency heating include elimination of other operations due to the fact that with induction heat treating, control is so exact that the heat-treat operation can be done as one of the later operations. Thus, time is saved by doing certain cuts while the steel is soft, rather than after the hardening operation. The capacity of the Acme generator is 20 kw.

River-Mapping by Radar

RIVER navigation charts are being made from radar photographs by the Army Corps of Engineers, Ohio River Division, using 3.2 centimeter radar equipment manufac-

FOR THE MOST EXACTING ELECTRICAL INSTALLATIONS

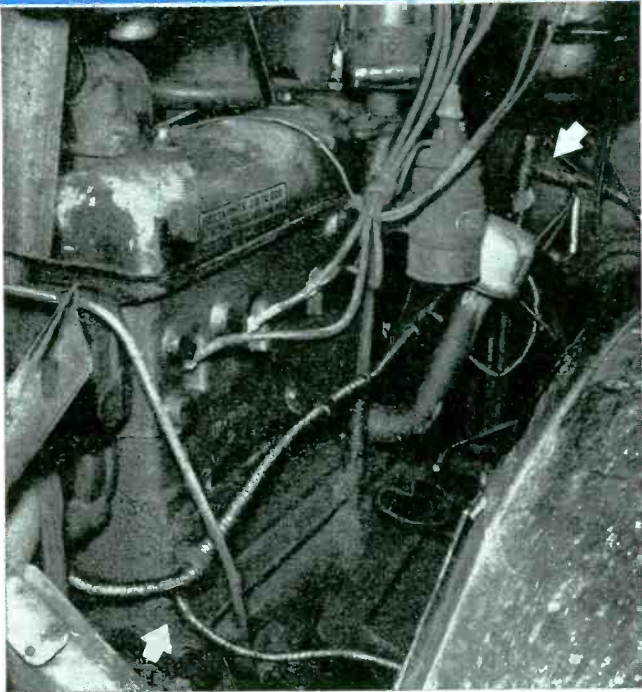

AUTOMOTIVE IGNITION HARNESSSES. Applied with a Segur taper adapted to the work with the cooperation of the National Scientific Products Co. Applied in this manner "SCOTCH" Electrical Tape with Vinyl Plastic Backing makes a securely bound but flexible harness; high resistance to oil, water, alcohol, heat, abrasion; high tensile strength.

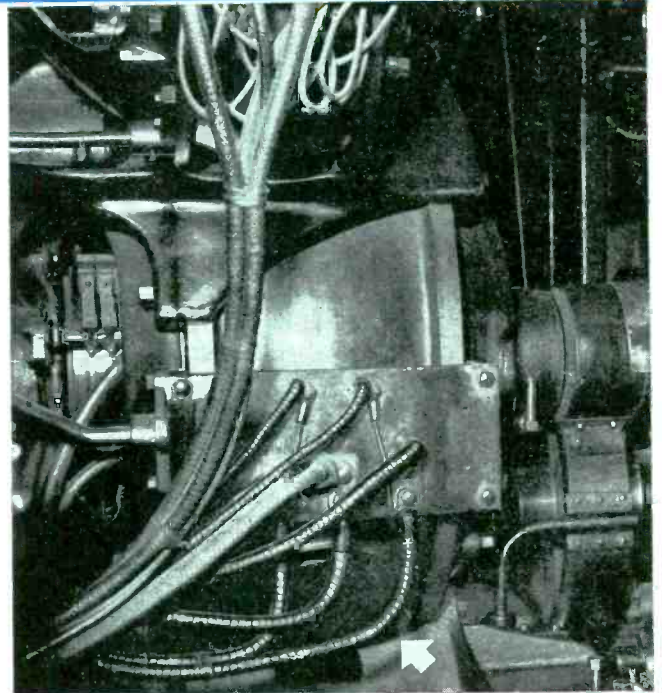

MACHINE TOOLS, PRINTING PRESSES. Where power wiring is subjected to oil, acids, etc., "SCOTCH" Electrical Tape with Vinyl Plastic Backing provides dependable resistance to oil; water, fresh or salt; acids; alkalis; alcohol; hydrocarbons.

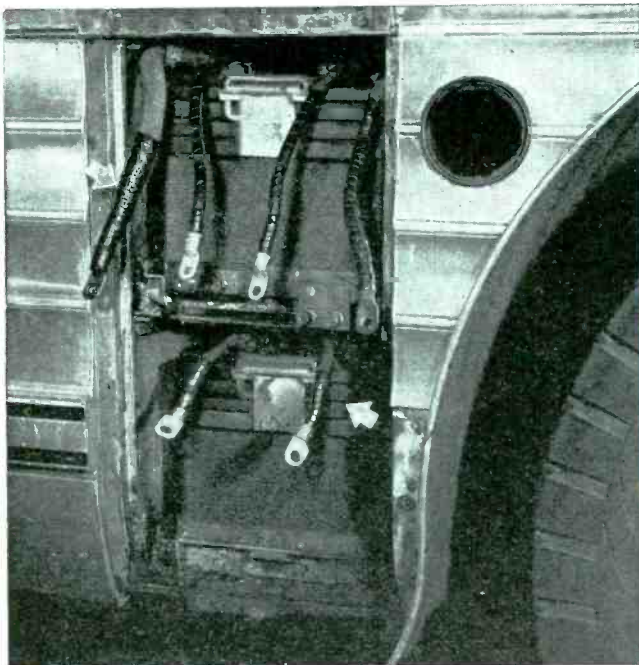

PROTECTIVE SHEATH FOR BATTERY CABLES. Above picture shows heavy battery cables protected with a tight spiral-wound sheath of "SCOTCH" Electrical Tape with Vinyl Plastic Backing. The acid and oil resistant qualities of this tape equip it to give fullest electrical and mechanical protection.



"SCOTCH" is the registered trademark for the more than 100 varieties of adhesive tapes

made in U. S. A. by

MINNESOTA MINING & MFG. CO.
THE 3M COMPANY
 SAINT PAUL 6, MINNESOTA

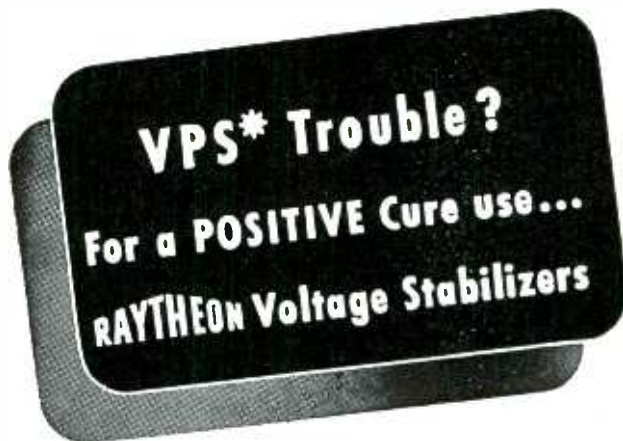

*Varying Power Supply need *not* prevent efficient, reliable and accurate performance of electrically operated equipment. A Raytheon Voltage Stabilizer of correct characteristics and capacity built into new equipment, or installed on old, provides constant output from varying input. Assure reliable and accurate performance of *your* equipment through *positive control* of power supply. Ask about Raytheon Voltage Stabilizers to meet *your* requirements.

Write for illustrated Bulletin DL-47-537

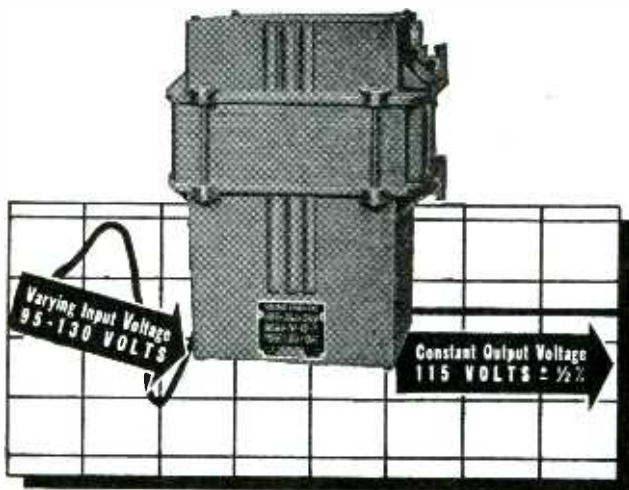

- OUTPUT VOLTAGE CONTROLLED to within $\pm 1/2\%$.
- STABILIZATION AT ANY LOAD within rated capacities.
- QUICK RESPONSE...varying input voltage stabilized within 1/20 second.
- ENTIRELY AUTOMATIC...no adjustments, no moving parts, no maintenance.



tured by Radiomarine Corporation of America.

An automatic camera is attached to the radar instrument and adjusted to photograph images on the scope at regular intervals. The prints are then matched to produce a continuous strip-map reduced to the scale of standard navigation charts. On the assembled charts, engineers add dotted lines indicating the channel to be followed, together with figures showing the depth of water, and brief identifying descriptions of important landmarks.

By using radar and radar charts, it is possible for a pilot to know exactly where he is and see the obstacles before him regardless of fog, darkness, or storm. Each image on the radarscope, whether showing an island, shoreline cliff, a building or a cluster of gas storage tanks, will be recognizable as though seeing the landmark itself.

The cost of charting a river by radar would be low in comparison to possible savings through speeding-up of river traffic and elimination of delays due to weather conditions.

Use of the 3.2-centimeter band makes possible sharp, clearly-defined images that are easily photographed from the radar's 12-inch scope. The high-frequency beam hugs the surface of the water and picks up buoys or other small objects over distances twice as great as those afforded by lower frequency radars of the type used in wartime. Two or more closely spaced objects appear as separate, distinct targets in their true relationship to each other. Locks, bridges, shorelines, channel markers and approaching tows can be picked up by the radar.

The narrow beam and short pulse length used provide a high order of bearing and range resolution, with objects discernible as close as 80 yards and out to $1\frac{1}{2}$ miles from the antenna. The radar can also be switched to longer ranges.

Brazing Lawn Mower Rotors

AN INTERESTING metal-joining operation by induction heating is the joining of three steel parts—a spider, drive shaft and bearing retainer—in one operation. This is

Nerves? OR Curves!

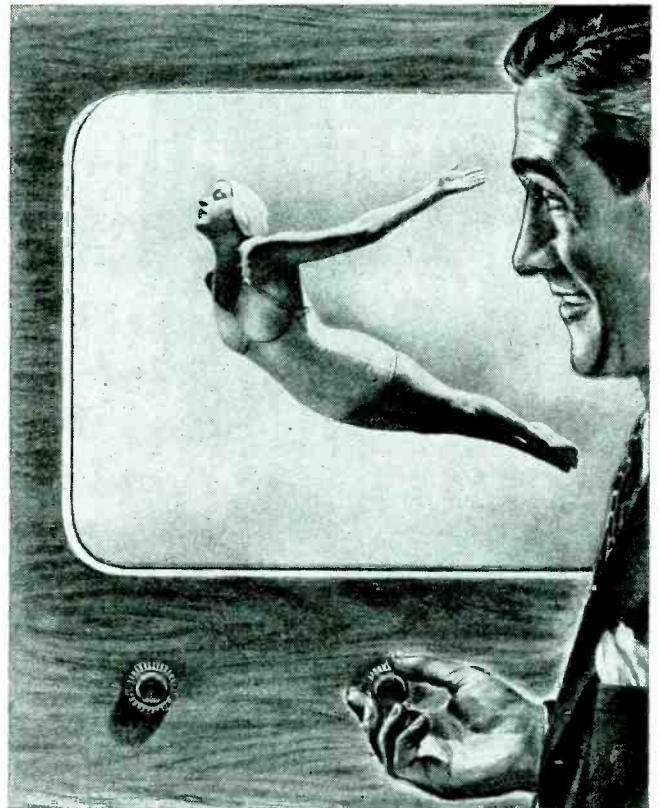
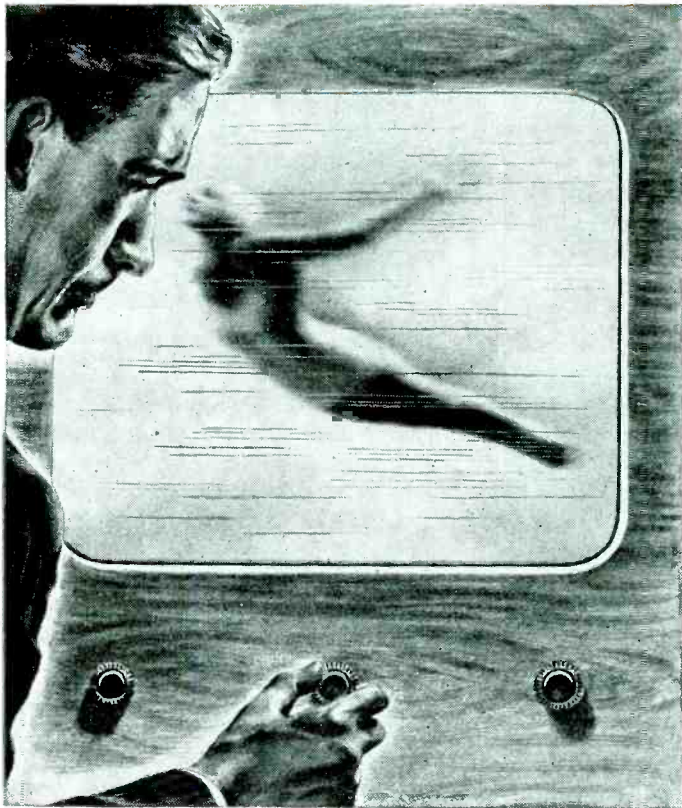

A Type ATV* Television Lead-In Line Can Make All the Difference

ANACONDA Type ATV lead-in lines are playing an important part in helping to give television buyers the kind of reception they want.

The well balanced design of conductors and dielectric in ATV lead-in lines minimizes the effects of attenuation and impedance mismatch. Satin-smooth polyethylene insulation sheds water readily — thus avoiding subsequent impedance discontinuities.

ATV line fulfills the most exacting requirements of wide-band reception — providing maximum freedom from distortion. Television buyers expect a lot. See that an ATV lead-in line helps your set to deliver!

47102

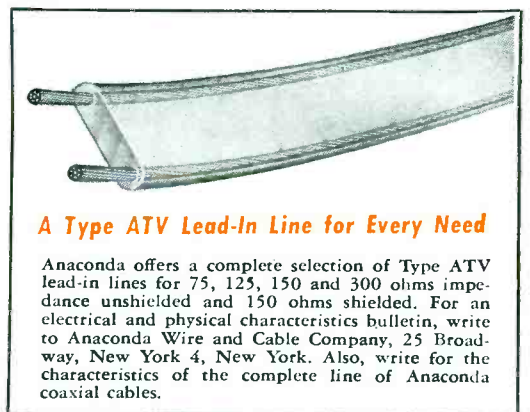

A Type ATV Lead-In Line for Every Need

Anaconda offers a complete selection of Type ATV lead-in lines for 75, 125, 150 and 300 ohms impedance unshielded and 150 ohms shielded. For an electrical and physical characteristics bulletin, write to Anaconda Wire and Cable Company, 25 Broadway, New York 4, New York. Also, write for the characteristics of the complete line of Anaconda coaxial cables.



ANACONDA WIRE AND CABLE COMPANY

*An Anaconda Trade-Mark

HOW TO BUY SPECIAL TRANSFORMERS from STANDARD PARTS

The special physical design or special electrical characteristic transformers you may need can probably be engineered from Acme Electric standard laminations and parts to the exact mechanical dimensions and electrical performance required. No need for special dies, tools or other expensive production materials. Here are a few of the Acme Electric designs available.



Mounting type 130, 2 hole horizontal mounting lead holes on bottom or side of shell. Ratings 15 to 100 VA.



Mounting type 110. Available in ratings from 35 to 2500 VA.



Mounting type 121. Available in ratings from 35 to 2500 VA. Taps to suit your needs.



Mounting type 131 with end bells. Leads out bottom or side. Ratings 35 to 500 VA.



Mounting type 150. 4 hole horizontal mounting. Lead holes on bottom or side of shell. Primary tap changer on top. Ratings 35 to 500 VA.



Mounting type 100. Available in ratings from 3 to 40 VA.

Write for Specification Transformer Bulletin 168.

ACME ELECTRIC CORPORATION
31 WATER STREET + + + CUBA, N. Y.

Acme ACME Electric

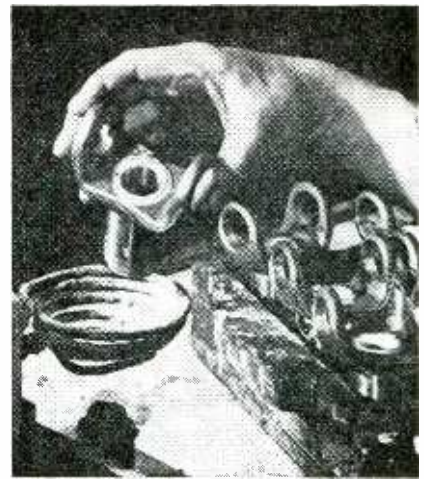

Inserting lawn mower rotor assembly in heating coil for brazing operation

being done by Reading Hardware Co. in fast time with alignment of parts held to close tolerances.

At the brazing station, a girl assembler places four spiders in a ceramic fixture and brushes the center hole of each with Handy Flux. A ring of Easy-Flo brazing alloy wire is then slipped on the drive shaft and the end of the shaft and the brazing alloy ring are liberally brushed with flux. A bearing retainer is placed over the shaft end and the two parts are then inserted in place on the spider. The fixture with four such assemblies is ready for heating.

The induction heating unit has two brazing stations equipped with jigs for aligning and maintaining close tolerances between parts, especially between the drive shaft and bearing retainer. The fixture holding the four assemblies is placed over the heating coils and all heating is done from the bottom. Heating coils do not interfere with the operation of the jigs which are lowered over the parts while heating. Heat can be concentrated on the heavier parts—the drive shaft and the spider—thus preventing warping in the lighter gauge bearing retainer. With coils so arranged the brazing alloy is drawn through the joint bonding the parts together accurately and permanently.

Four assemblies are brazed at one time. It takes but 30 seconds, an average of 7.5 seconds each. With two brazing stations, one heating while the other is loaded, a production of 3,840 units can be maintained per eight-hour day.

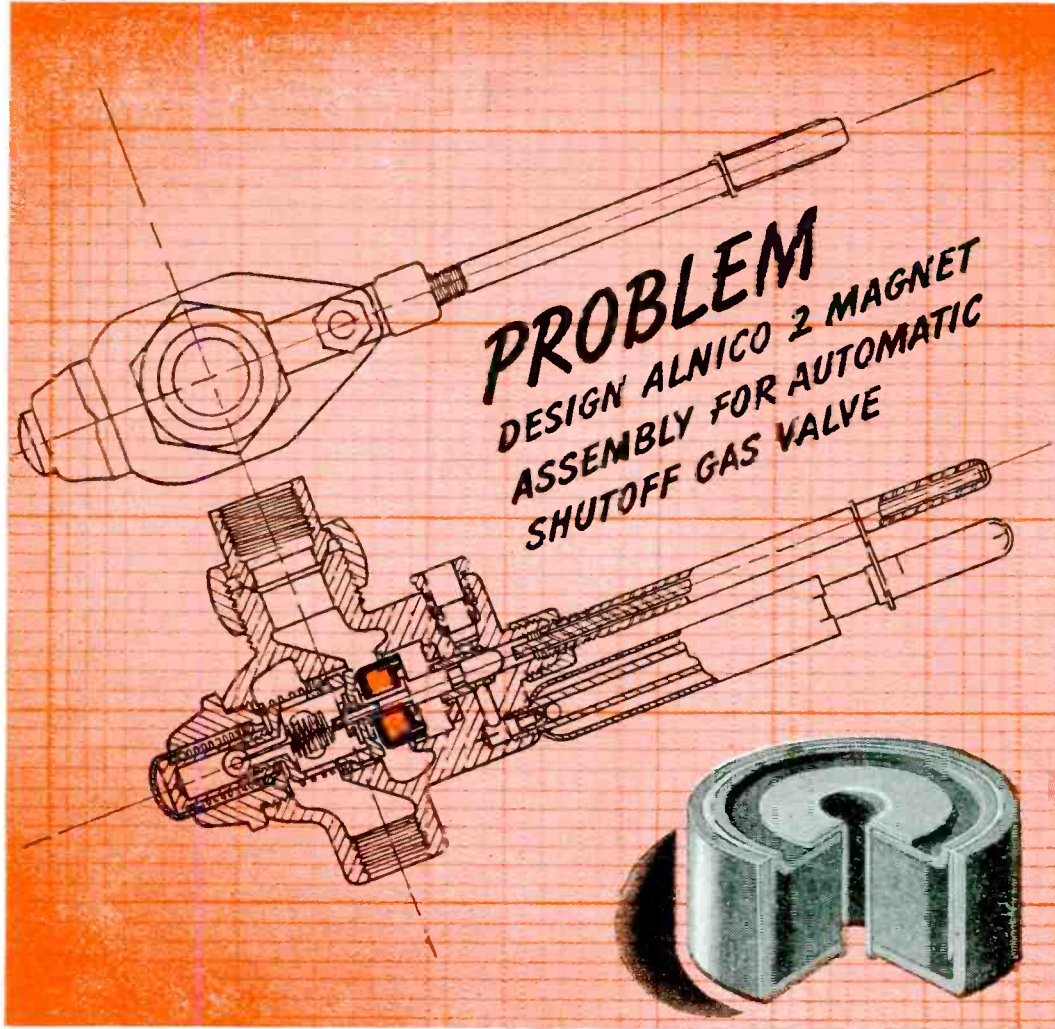

PROBLEM
 DESIGN ALNICO 2 MAGNET
 ASSEMBLY FOR AUTOMATIC
 SHUTOFF GAS VALVE

Designed by G-E engineers, this ALNICO permanent magnet holding assembly insures positive snap action in the Titan 100% Shutoff Automatic Safety Pilot manufactured by the Titan Valve and Mfg. Co.



The Magnet that Safeguards your Gas Heater

Here's a magnetically controlled pilot light for your gas heater that's 100% safe. While the pilot flame is burning, the ALNICO permanent magnet assembly grips a steel ring, keeping the gas line open. When the flame goes out, a thermal device and retaining spring force the holding magnet assembly away from the ring, shutting off the gas supply.

We shall be glad to help you also with your magnet application problems. Backed by years of research and magnet design experience, General Electric engineers are always at your service.

The precise quality control methods used throughout G-E magnet production plus accurate testing and rigid inspection, assure you of receiving magnets of the highest uniform quality for your application.

Moreover, greater flexibility of magnet design is possible with the many G-E permanent magnet materials now available. These include cast and sintered ALNICO, the ductile alloys CUNICO, CUNIFE and SILMANAL and lightweight non-metallic VECTOLITE. *Metallurgy Division, General Electric Company, Pittsfield, Mass.*

Send for our new bulletin, CDM-1, "G-E Permanent Magnets," specifically designed to help you with your permanent magnet problems. This bulletin contains information about the characteristics and properties of G-E permanent magnet materials, their application and design.

METALLURGY DIVISION, Sec. FA-9
 CHEMICAL DEPARTMENT
 GENERAL ELECTRIC COMPANY
 PITTSFIELD, MASS.

Please send me your new bulletin, CDM-1, "G-E Permanent Magnets."



NAME..... TITLE.....
 COMPANY.....
 ADDRESS.....
 CITY..... STATE.....



**PERMANENT
 MAGNETS**

GENERAL ELECTRIC

CD47-J A6

Split "K" shells as they come from one of Cannon's 25 diecasting machines.

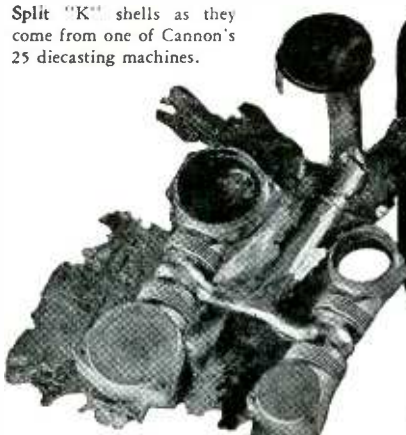

FROM DIECASTING TO COMPLETED PLUG All Under One Roof



"K" Angle 90° end bell after the "flash" has been removed.

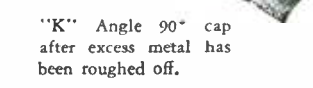

"K" Angle 90° cap after excess metal has been roughed off.

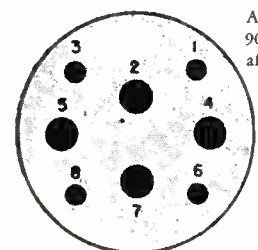

Assembled "K" Angle 90° end bell and cap after finishing.

NK-L8 insert carries 4 No. 14 and 4 No. 8 contacts (3/32" clearance).

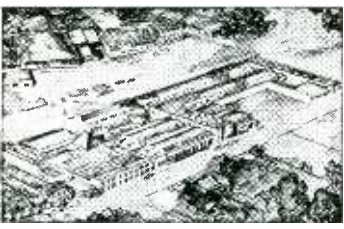

This continuous quality-controlled production is under the constant scrutiny of leadmen, foremen and inspectors. When you buy Cannon Plugs you can rest assured that you have purchased the ultimate in engineering design and a quality product which is the result of years of specialized effort for the leading manufacturers of aircraft, radio, television, radar, instruments, microphones, communications and general electrical equipment.



WK-M2 insert, measuring 3/8" diameter, carries two No. 16 contacts (7/64" clearance). This phenolic insert may be used in any WK size shell.

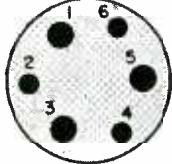

GK-P6 insert carries 3 No. 14 and 3 No. 10 contacts (3/64" clearance). Insert diameter 7/8".

Largest insert diameter is "AK" with a maximum of 82 contacts.

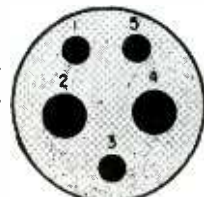

SK-C5 insert carries 3 No. 10 and 2 No. 6 contacts (1/16" clearance). One of the 188 inserts available.



Finished cap and end bell, conduit entry type, sand blasted and lacquered (or tin plate and lacquered). These are standard finishes. Others are available upon special request.



K-23C Complete angle 90° assembly with integral clamp (cable entry).

While the Los Angeles Cannon Electric plant comprises two buildings, the manufacturing and assembly are now located in Plant No. 2 under one roof, so to speak, where the various processes from diecasting aluminum and zinc shells through the molding and fabricating of the insulators (insert arrangements) and the milling of contacts through to final assembly are completed.



Further information on the plug and receptacle designs will be mailed upon request. Ask for the Type "K" Bulletin. Address Dept. 1-120, Cannon Electric Development Co., 3209 Humboldt St., Los Angeles 31, Calif. Export office for world area, except in Britain and possessions, Frazer and Hansen, 301 Clay St., San Francisco, California.

**CANNON
ELECTRIC**
DEVELOPMENT COMPANY
3209 Humboldt St., Los Angeles 31, Calif.
IN CANADA:
CANNON ELECTRIC COMPANY, Ltd., TORONTO



SINCE 1915

ELECTRON ART
(continued from p 138)

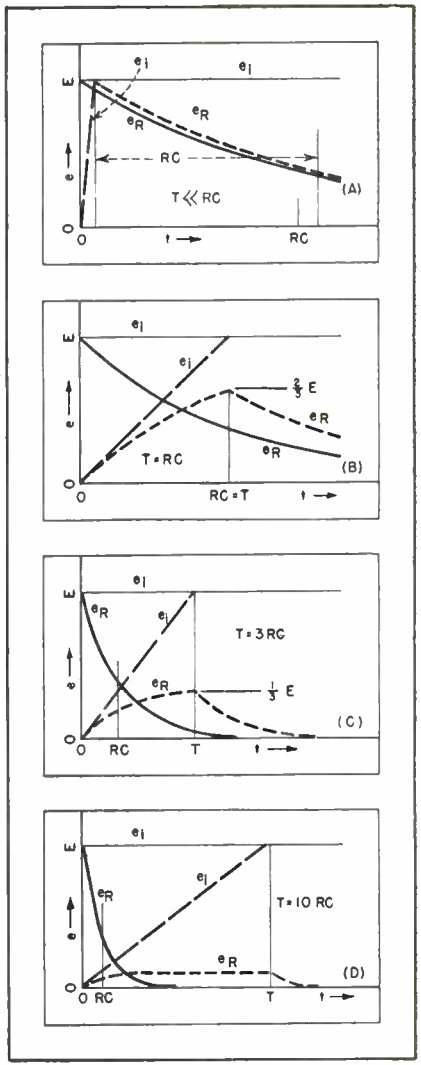

FIG. 3—Comparison of response to square-wave to that of linearly rising wavefront for various pulse periods relative to the circuit time constant shows considerable difference for relatively long pulses

= 7 or greater, the exponential term in Eq. 3 becomes less than 0.001, and the voltage rises in time T to $e_R = E/a$. For example, consider the case of $a = 10$. When the input voltage wavefront reaches its full value of E at $t = T = 10RC$, the voltage across the resistor reaches within better than 0.01 of one percent of its maximum value of $0.1E$. Actually the voltage has reached 95 percent of this value at $t = 3RC$ thus

$$e_R = (E/a) (1 - e^{-3}) = 0.095E \quad (7)$$

These four cases are illustrated in Fig. 3. The solid e_i curves are the square input voltage; the solid e_R curves are the output voltage (Fig. 2) resulting from such an input. The dashed e_i curves are a linearly rising input voltage; the dashed e_R curves are the output

Now... A 7-INCH OSCILLOSCOPE

AT THE SENSATIONALLY LOW PRICE OF ONLY \$124⁵⁰—



IDEAL FOR
LABORATORY USE
INDUSTRIAL APPLICATIONS
SERVICING JOBS
CLASSROOM INSTRUCTION

SYLVANIA ELECTRIC

MAKERS OF ELECTRONIC DEVICES; RADIO TUBES; CATHODE RAY TUBES;
FLUORESCENT LAMPS, FIXTURES, WIRING DEVICES; ELECTRIC LIGHT BULBS

The new Sylvania 7-inch Oscilloscope Type 132 incorporates many features that give it an exceptional range of utility in radio service shops, laboratories, plants and colleges.

JUMBO PATTERNS

Use of the large 7-inch Sylvania Cathode Ray Tube Type 7GP1 provides "jumbo" patterns which enhance the value of the instrument for instruction purposes as well as in shop and laboratory.

A new push-pull deflection circuit provides clearer patterns, less distortion and more gain.

INTENSITY MODULATION

Observation of a wider variety of phenomena is made possible by the addition of a Z axis input for intensity modulation. This feature is useful in studying pulses and portions of cycles, and leads to many applications in industry.

Type 132 is designed and built to provide the finest instrument in its class. The panel is "efficiency designed" with control size and placement offering time-saving ease of operation.

And... it's priced within the range of the average budget!

Cabinet size is 17" high by 11 $\frac{3}{8}$ " wide by 17 $\frac{3}{4}$ " deep. Weight is 37 pounds, and convenient carrying handle is supplied.

Instrument consumes 35 watts from 105-125 volt, 50-60 cycle line. Extra-long heavy-duty line cord is furnished.

Product of Sylvania's Electronics Division, Oscilloscope Type 132 is distributed through the Radio Tube Division. Instrument may be purchased from Sylvania Distributors.

For more complete information on the Type 132 Oscilloscope, together with application notes, hints and suggestions on the use of Oscilloscopes, mail the coupon below.

Sylvania Electric Products Inc.,
Dept. E1409, Electronics Division
500 Fifth Avenue, New York 18, N. Y.

Gentlemen:

Please send full details on Oscilloscope Type 132.

Name

Business Connection

Street Address

City Zone #

State

RADIO'S NEWEST MULTI-PURPOSE INSTRUMENT

MEASUREMENTS

Model 59

MEGACYCLE METER

The Model 59 consists of a compact oscillator connected by a flexible cord to its power supply. The instrument is a variable frequency oscillator, an absorption wave-meter, an oscillating detector and a tuned absorption circuit detector. The engineer, technician, service man or amateur will find the Model 59 a most versatile instrument suitable for many applications.

SPECIFICATIONS:

FREQUENCY:

2.2 Mc. to 400 Mc., seven plug-in coils.

MODULATION:

CW or 120 cycles; or external.

DIMENSIONS:

Power Unit, 5 1/4" wide; 6 1/2" high; 7 1/2" deep.
Oscillator Unit, 3 3/4" diameter; 2" deep.

POWER SUPPLY:

110-120 volts, 50-60 cycles; 20 watts.



MODEL 59 APPLICATIONS:

- For the determination of the resonant frequency of tuned circuits, antennas, transmission lines, by-pass condensers, chokes or any resonant circuit.
- For measuring capacitance, inductance, Q, mutual inductance.
- For preliminary tracking and alignment of receivers.
- As an auxiliary signal generator; modulated or unmodulated.
- For antenna tuning and transmitter neutralizing, power off.
- For locating parasitic circuits and spurious resonances.
- As a low sensitivity receiver for signal tracing.

Descriptive Circular on Request

MANUFACTURERS OF
Standard Signal Generators
Pulse Generators
FM Signal Generators
Square Wave Generators
Vacuum Tube Voltmeters
UHF Radio Noise & Field
Strength Meters
Capacity Bridges
Megohm Meters
Phase Sequence Indicators
Television and FM Test
Equipment

MEASUREMENTS CORPORATION
BOONTON NEW JERSEY

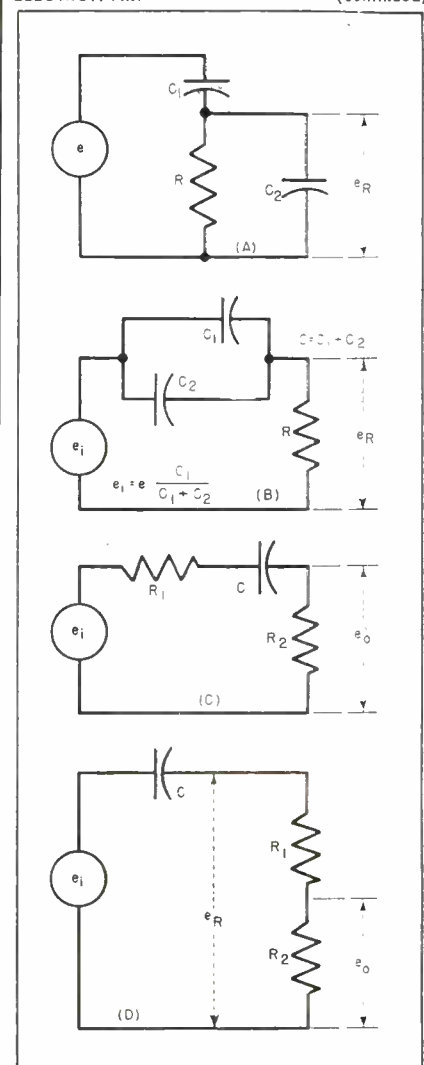

FIG. 4—Several circuits, slightly more complex than that of Fig. 2, can be analysed by the exact same technique. Other more complex circuits can be analysed by analogous techniques

from such an input. In Fig. 3A there is little difference between the output obtained from a square or a linearly rising waveshape. However in Fig. 3B there is a noticeable difference. In Fig. 3C and especially Fig. 3D there are no similarities. The errors resulting from assuming a squarewave are obvious.

Until now we have been discussing the rise period. After the input voltage has reached its maximum at time T , it remains constant for the duration of the pulse, and the voltage across the resistor falls exponentially, in accordance with the equation

$$e_R = E_R e^{-(t-T)/RC} \quad (9)$$

where E_R is the maximum voltage reached across the resistor, and time is still measured from the origin of the pulse front. At the

Have You Tried Ceramic Condensers for General Purpose Applications?

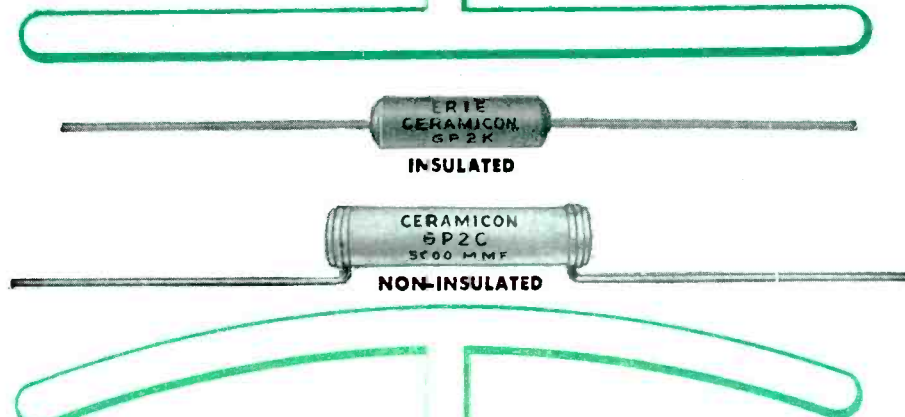

Specify **Erie "GP" Ceramicons**
for best performance

REG. U.S. PAT. OFF.

Many leading radio manufacturers have already switched to ERIE "GP" Ceramicons for general purpose applications. These ceramic condensers have all the well-known dependability of other ERIE Ceramicons with their sturdy compactness and ease of installation, *plus* an unprecedented economy for general purpose applications.

ERIE "GP" Ceramicons are designed for practically all applications in which the condenser is not directly frequency determining; for AVC Filtering, Resistance-Capacitance Audio Coupling, Tone Compensation, Volume Control R.F. By-Passing, Audio Plate R.F. By-Passing, Oscillator Grid Coupling, R. F. Coupling, Antenna Coupling.

The production of large quantities at one time of a given capacity value accounts for their economical price . . . *there is no sacrifice in quality.*

Condensers classified as GP1 have a temperature coefficient between +130 and -1600 P/M/°C and are available up through 150 MMF. Condensers classified as GP2, manufactured in capacities of 120 MMF and higher, may include all of the above dielectrics and, in addition, the ERIE Hi-K type.

ERIE "GP" Ceramicons are made in insulated styles in popular capacity values up to 5,000 MMF, and in non-insulated styles up to 10,000 MMF. Write for full details.

Electronics Division
ERIE RESISTOR CORP., ERIE, PA.
LONDON, ENGLAND • • TORONTO, CANADA



**AS GOOD
AS IT LOOKS**



MODEL S20X

WITH SLIDE-LOCK SWITCH AS ILLUSTRATED AT SLIGHT EXTRA COST

ALL THESE FEATURES AT LOW COST

- ★ Metaseal crystal
- ★ High level: 54db below 1 volt/dyne/sq. c.m.
- ★ Smooth response: ± 5 db from 50-7000 c.p.s.
- ★ Corrosive resistant aluminum diaphragm
- ★ Convenient, light weight
- ★ Modern styling
- ★ Turner quality

Microphones **BY TURNER**

It's the new Turner Model S20X Hand Microphone for home recording, public address and amateur work. Beautifully finished in rich baked brown enamel. Light in weight and convenient to use. Fits the hand perfectly, hangs on a hook when not in use.

Its performance is the kind you expect in a microphone costing three times as much. Response to voice and music pickups is smooth and flat over the most desired frequency range. Level is exceptionally high. The entire circuit is shock mounted to withstand rough treatment and is equipped with barometric compensator.

SEND NOW FOR BULLETIN

THE TURNER COMPANY

905 17th Street N.E. • Cedar Rapids, Iowa

TURN TO TURNER FOR SOUND PERFORMANCE

CRYSTALS LICENSED UNDER PATENTS OF THE BRUSH DEVELOPMENT CO

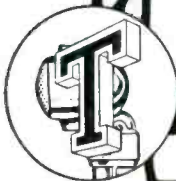

tail of the pulse, a similar differentiated pulse appears with opposite polarity. We have used the term differentiation somewhat loosely, as the center portion of the differentiated pulse, between the two spikes, must be included in the concept of differentiation as applied to pulses.

Rules of Thumb

Comparing the results from assuming a linearly rising pulsefront with those resulting from assuming a perfectly square pulsefront (Fig. 3), we see how misleading the latter assumption can be. For example, in case four, the output voltage approaches very closely the true mathematical differential of the input wave, except for amplitude, as the input wave is Et/T and the output is $e = E/a$ during the rise time.

Rules of thumb for anticipating pulse response of circuits are therefore as follows:

(1) If the time constant of the circuit is much greater than the rise time of the pulse, the pulsefront is transferred across the circuit with slight loss in voltage (Fig. 3A).

(2) If the time constant of the circuit is about equal to the rise time of the pulse, the voltage output maximum is about $\frac{2}{3}$ of the input (Fig. 3B).

(3) If the time constant of the circuit is $\frac{1}{2}$ or less of the rise time of the pulse, the output voltage is approximately this fractional proportion of the input (Fig. 3C and 3D).

Practical Applications

There are several practical points which should be considered regarding the effect of the associated physical circuits to which the above differentiating circuit is connected. First, R should represent the complete effective load on the differentiating circuit. Second, usually some capacitance exists across the resistor, shown as C_2 in Fig. 4A. In this case, by application of Thevenin's theorem, there results Fig. 4B, to which we can apply the results arrived at above. The voltage produced across R by placing C_2 in parallel with C_1 , and replacing the input voltage with the reduced input voltage $e_i = eC_1/(C_1 + C_2)$,

**For Temperature Ranges
from 500° F. to -85° F.**

**Varglas Silicone Electrical Insulating Tubing and Sleeving
Lead Wire and Tying Cord**

VARGLAS SILICONE is a sensationally new electrical insulating sleeving and tubing developed by our laboratory and pilot plant during the war. It is a product which combines Varglas and Silicone to bring revolutionary possibilities to electrical insulation.

VARGLAS SILICONE is efficient under a wide temperature range...to 500°F. or more in some applications, yet remains completely flexible at -85°F. It has excellent resistance to moisture and lubricating oil, is flame resistant and self-extinguishing, and is the strongest of the accepted insulating materials.

**VARGLAS SILICONE, pioneered by VARFLEX CORPORATION,
is the first combination of these outstanding features:**

1. **VARGLAS**—Continuous filament Fibreglas—a moisture and fungus proof material which will not burn and is chemically inert—strong and flexible at high and low temperatures.
2. **NORMALIZING**—Removes binder and organic inclusions from the Fibreglas—improves electrical qualities and allows uniform impregnation.
3. **SILICONE HIGH TEMPERATURE RESIN**—Which has a natural affinity for the Fibreglas, renders it abrasion-resistant, flexible and non-fraying.

VARFLEX CORPORATION, manufacturers of electrical insulating tubing and sleeving, are insulation specialists. If you require special insulation, write us about your problems. We will gladly quote on your individual requirements or ASTM specifications. We have a complete line of sleeving and tubing, based on Fibreglas, cotton, and extruded plastics.

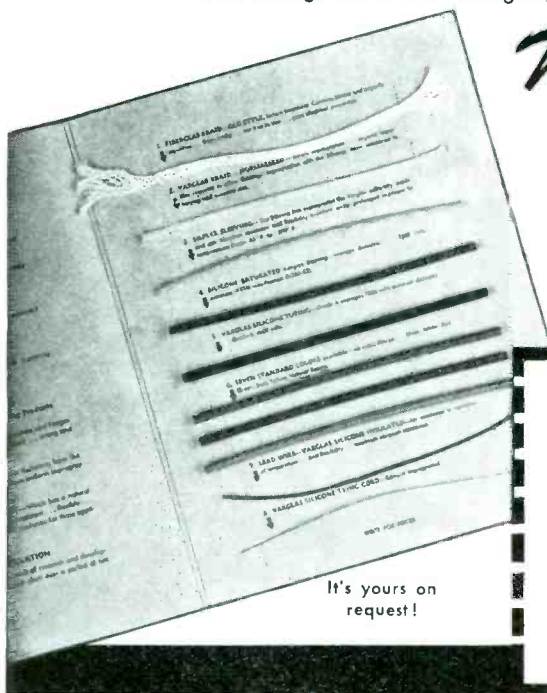

Now, Varflex invites you to test these free samples of Varglas Silicone in your own plant or laboratory.

Just Clip this coupon!

VARFLEX CORPORATION
308 N. JAY ST. ROME, N. Y.



Please send me folder containing free samples of Varglas Silicone products.

Name

Company

Address

City Zone State

VARFLEX CORPORATION, 308 N. JAY ST., ROME, N. Y.

Quality components are essential to the measurement of radiation



Victoreen Hi-Megohm resistors in a range of values from 100 megohms to 10,000,000 megohms fill an urgent need in the production of sensitive instrumentation. Unusual stability with low voltage and temperature coefficients within the recommended operating ranges. Vacuum sealed in glass with special surface treatment.

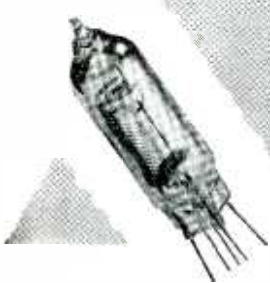

A new low microphonic feature recently incorporated in the VX series of subminiature electrometer tubes takes its place beside such other characteristics as filament current of 10 ma. and grid resistance of better than 10^{15} ohms which are unobtainable in any other tube. Designed to make fine instrumentation even better. Available also as diodes, triodes and tetrodes.

The VXR-130 subminiature gaseous voltage regulator tubes provide a new production and laboratory tube innovation. It supplies very close regulation with extreme stability where regulation must be maintained over a long period of time. Operation is at 130 volts at an operating current range of 1.0 to 2.5 ma. Write for particulars.

Victoreen provides a complete range of instruments for measurement and protection in the field of nuclear physics including Geiger-Mueller counting systems and scaling circuits for the laboratory or portable instruments for field service. The experience of twenty years devoted exclusively to radiation instruments assures quality performance.

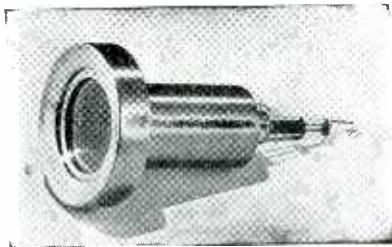

The VG series mica window Geiger-Mueller Counter is designed for exacting laboratory requirements.

Production is closely controlled for uniform and consistent tube characteristics. Highly regarded and recommended by research and laboratory engineers.

Offered in window thicknesses from 4.5 to 2.0 mgm. per sq. cm. Plateau length 200 volts, slope of plateau less than 5 volts per 100 volts.

THE VICTOREEN INSTRUMENT CO.
5806 HOUGH AVENUE
CLEVELAND 3, OHIO

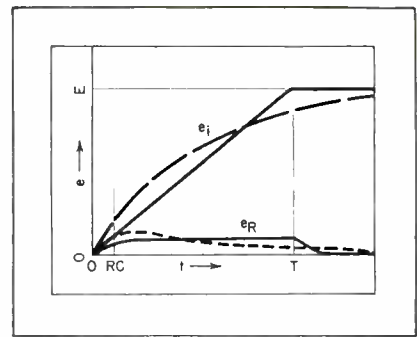

FIG. 5—Comparison of results assuming a linearly or an exponentially rising wave-front shows that they give results of the same order of magnitude

as shown in Fig. 4B, is the same as in the original circuit (Fig. 4A).

Third, the above analysis assumes that the output resistance of the generator supplying e_i is negligible in comparison with R . If this is not so, we can reduce it to this case as follows. In Fig. 4C, R_1 is the output resistance of the source, and R_2 is the load resistance. This circuit is exactly the same as Fig. 4D. Thus the results of the previous analysis apply by using the value of $R_1 + R_2$ as R to get e_R , and then multiplying by the ratio $R_2/(R_1 + R_2)$ to get the actual output voltage e_o .

Figure 5 illustrates, for the sake of comparison, an exponential pulse front (dashed e_i) with a time constant of one half the rise time of the comparable linear pulse front (solid e_i) shown with it. The output voltage across the resistor due to the exponential pulse front (dashed e_R) may be compared with that due to the linear front (solid e_R) as an indication of the reliability of the second order approximation compared to the third order one. The assumption of linearly rising pulse front is quite reliable.

(1) G. P. Ohman, Square-Wave Differentiating Circuit Analysis, *ELECTRONICS*, p 132 Aug 1945.

(2) Gershon J. Wheeler, Laplace Transforms for Electronic Engineers, *ELECTRONICS*, p 304 Feb 1945.

(3) N. W. McLachlin, "Complex Variable and Operational Calculus with Technical Applications", McMillan Co., 1944, Chapter 10.

Voltmeter for Pulses

HIGH INPUT IMPEDANCE is obtained in a vacuum tube voltmeter for use with pulses by the accompanying circuit. Basically it is a conventional diode rectifier, using the first

FRANKLIN *Television* SOCKETS

*Designed and manufactured
in the traditional Franklin manner...
by skilled craftsmen
of the finest materials known.
With radial leads for shallow mounting.*



DIHEPTAL

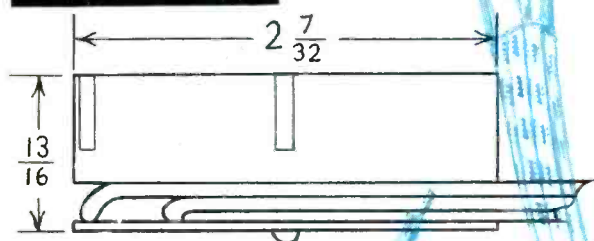

DUODECAL

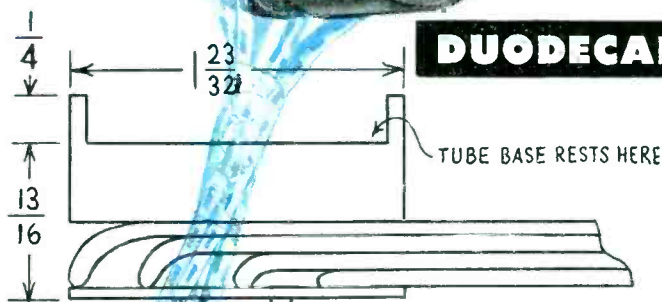

FRANKLIN MINIATURE SOCKETS . . . series 57 miniature wafer sockets . . . incorporate new contacts of revolutionary design and embody features not available heretofore . . . their spring type contacts grip and hold the tube securely without the need for locking devices . . . being longer and spaced farther apart easy soldering is possible with resulting lower production costs.

Series 57 Miniature Wafer Sockets will find high favor with engineering departments for their positive constant contact . . . with production departments for their ease of soldering and elimination of locking devices . . . and with purchasing departments for their low prices.

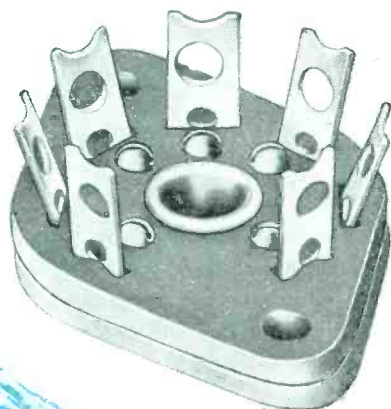

- 57 A 12 for 1-5/16" mounting centers
- 57 A 23 for 7/8" mounting centers
- 57 A 11 for 1" mounting centers.

(57 A 12 is interchangeable with Octal Sockets of like mounting center enabling chassis design for use with either.)

A. W. FRANKLIN MFG. CORP.

MANUFACTURERS OF A COMPLETE LINE OF RADIO AND TELEVISION TUBE SOCKETS

43-20 34th STREET • LONG ISLAND CITY 1, NEW YORK



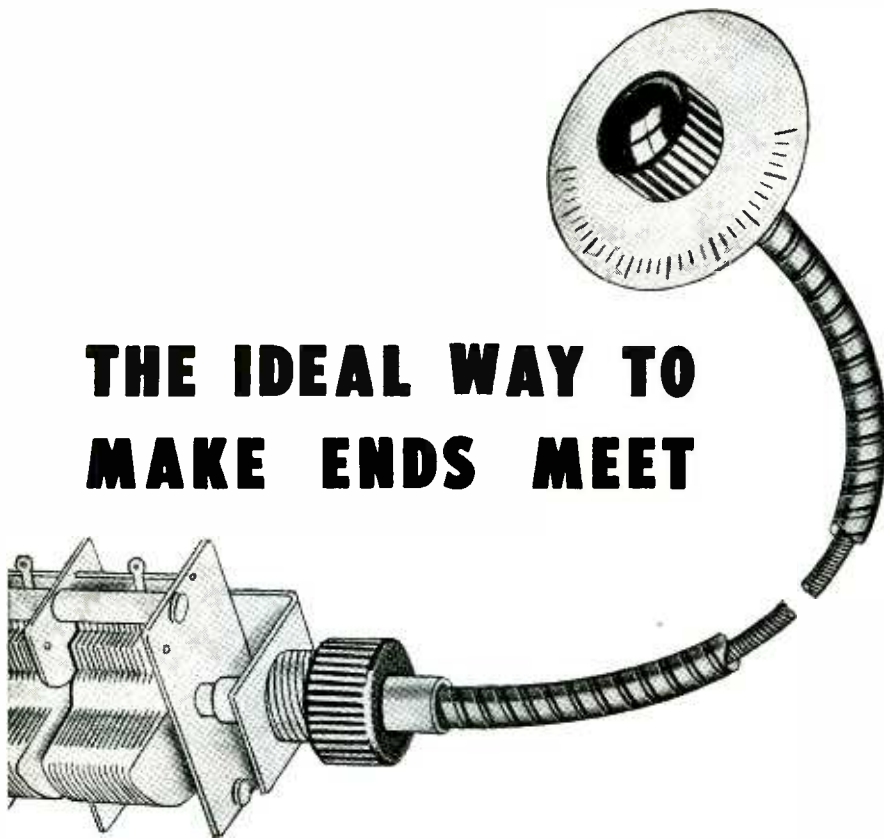

THE IDEAL WAY TO MAKE ENDS MEET

IN electronic equipment design, the placing of variable elements is governed by these considerations:

1. Optimum circuit efficiency.
2. Operating convenience.
3. Easy assembly and wiring.
4. Space saving.
5. Accessibility for servicing.
6. Orderly panel appearance.

To satisfy one and all of these requirements looks like a large order. Actually, it's very simple. Just hook up the variable elements to their control knobs with—

S.S. WHITE REMOTE CONTROL FLEXIBLE SHAFTS

This gives you complete freedom in placing both the elements and the knobs anywhere you want them! It's as easy as that.

These shafts are especially engineered and built for the job. With proper application, they can't be distinguished from a direct connection for easy, smooth turning and sensitivity—and they retain their characteristics indefinitely. Full details about these shafts are included in this

260-PAGE FLEXIBLE SHAFT HANDBOOK

COPY FREE if you write for it on your business letterhead and mention your position.



S.S. WHITE INDUSTRIAL DIVISION
THE S. S. WHITE DENTAL MFG. CO. DEPT. E 10 EAST 40th ST., NEW YORK 16, N. Y.

FLEXIBLE SHAFTS • FLEXIBLE SHAFT TOOLS • AIRCRAFT ACCESSORIES
SMALL CUTTING AND GRINDING TOOLS • SPECIAL FORMULA RUBBERS
MOLDED RESISTORS • PLASTIC SPECIALTIES • CONTRACT PLASTICS MOLDING

One of America's AAAA Industrial Enterprises

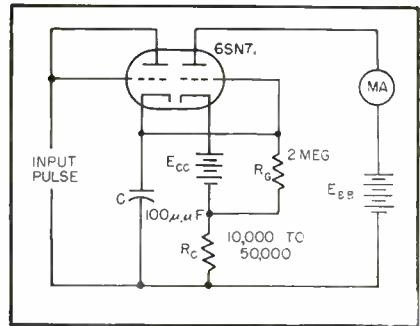

Voltmeter responds equally well to pulses from one to 20 microseconds duration

section of a 6SN7 with grid tied to plate, followed by a cathode coupled amplifier (cathode follower). Other tube combinations might be better (perhaps a 6SQ7). Amplifier grid bias is adjusted, depending on the plate supply voltage, to approximately cut off the amplifier plate current.

Capacitor C is charged through the diode during a positive pulse. The charge then leaks off through resistors R_o and R_c . However, the triode section of the 6SN7 then passes current developing a voltage across R_c to oppose the discharge of the capacitor. The time constant of the output circuit is thus increased. This increase of time constant of the actual circuit over that of the passive circuit elements alone approaches the amplification factor of the amplifier tube as R_c approaches the internal tube resistance. Because of the increased time constant of the output circuit, the capacitor can be small, thus increasing the input impedance of the voltmeter. Indication can be either by a plate milliammeter as shown, or by a conventional voltmeter across R_c . (A High Impedance Pulse Voltmeter, D. E. Howes, *Rev Sci Inst*, p 322, Nov 1945)

Pulse Rise and Decay Time Measurement

By ALLEN EASTON
Long Island City, N. Y.

PRECISE MEASUREMENT of rise and decay characteristics of pulses is a necessary adjunct to their expanding application. Various characteristics of pulses are defined in Fig. 1. The rise or decay time can be measured by one of the common methods illustrated in Fig. 2. If

ERSIN

Multicore



**IS THE ONLY THREE CORE SOLDER
IN THE WORLD WHICH IS MADE WITH
EXTRA-ACTIVE NON-CORROSIVE
ERSIN FLUX**

which gives you guaranteed flux continuity and ensures a high standard of precision soldered joints. Three cores of flux in Ersin Multicore Solder give quick melting and more rapid soldering. The Multicore construction ensures flux continuity and the correct proportion of flux to solder. If you would like to know more about Ersin Multicore please write to us for detailed technical information.



**ERSIN MULTICORE SOLDER GIVES YOU HIGH SPEED
PRECISION PRODUCTION — THE SECRET IS IN THE
ERSIN FLUX (EXCLUSIVE TO MULTICORE) COMBINED
WITH MULTICORE CONSTRUCTION.**

Ersin Multicore Solder is made as standard in gauges between 10 and 22 S.W.G. (.128 — .028 ins., 3.251 — .711mm.) and in five standard antimony free alloys. Other gauges or alloys can be supplied to order. Only the finest tin and lead are used in the manufacture of Ersin Multicore Solder.

U.S.A. enquiries to

BRITISH INDUSTRIES CORP., 315, Broadway, New York 7, N.Y.

Canadian enquiries to

SNI-DOR RADIOELECTRIC LTD., 455 Craig Street West, Montreal

Enquiries regarding other territories to

MULTICORE SOLDERS LTD., Mellier House, Albemarle Street, London, W.1, England.

Tel: BFCent 444 Cables: Durticken, Piccy, London

For arc-proofing phenolic panels—

INSULATE WITH INSL-X U-95 DIELECTRIC COATING

featuring:

- ★ PERMANENT GOOD ADHESION
- ★ HIGH ARC RESISTANCE
- ★ WEATHER & MOISTURE RESISTANCE
- ★ BRUSH, DIP OR SPRAY APPLICATION
- ★ RAPID, FLASH BAKE

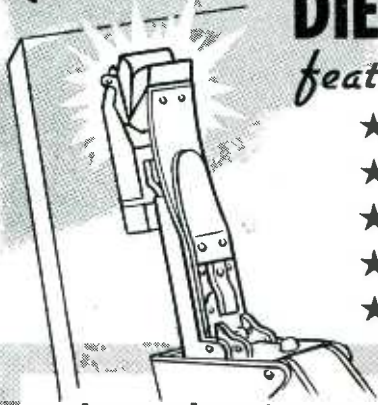

A good resistor coating, too!

INSL-X U-95 arc-resistant coating is a special synthetic resin blend of the thermosetting type. It is quickly and easily applied by brush, dip or spray. A minimum heat is required for conversion. The dried coat will not soften under heat and readily withstands short time temperatures as high as 500° F. Arc resistance, extraordinary adhesion, immunity to

solvents and exceptional abrasion resistance are additional qualities that have made this coating one of the most popular available for insulating resistors and arc-proofing molded or laminated panels. Dielectric strength is approximately 1800 volts per mil. U-95 is available clear or in colors. Detailed information furnished on request.

PLASTIC DIP COATINGS—

Designed for insulating tools, the E-33 coat is also serviceable for use on radio parts, aircraft parts, switchboard or power line equipment. Film is tough, waterproof, and withstands abuse. It is immune to acids, alkalis and petroleum derivatives. It is easy to apply—simply dip and dry. Dielectric strength is very high.



BUS BAR COATINGS—

INSL-X E-11 for round bus bars and E-12 for square bars eliminate slow, untidy taping or cambric covering of bars. A two mil coat increases the carrying capacity of a bus 30% over tapered bars through increased heat radiation. Dielectric strength is 2000 volts per mil in thin layers.



OTHER
EASY-TO-APPLY
INSL-X
COATINGS

FLEXIBLE COATINGS—

E-22 is a highly flexible coat that can be quickly applied by brush, dip or spray. It provides excellent moisture proofing and sealing features: superior mechanical and dielectric qualities. E-22 is ideal for coating metal chassis, cabinets, etc. to eliminate arcing, grounding and corona.



COIL COATINGS—

INSL-X E-67 is an outstanding coat for small coils. It is not an impregnant but provides a covering of unusual characteristics and mechanical strength. Dielectric strength is high—1100 volts and tensile strength is over 1000 psi. Application may be by dip or spray. Softening with heat permits shaping of coils.



INSL-X materials have no equal for preventing moisture infiltration and, at the same time, providing maximum dielectric and mechanical strength with minimum thickness. They are easy to use, do not chip or become brittle. Data concerning the complete line of INSL-X products is available: address inquiries on letterhead.

THE INSL-X COMPANY • INC.
MANUFACTURING ENGINEERS OF INSULATING, FUNGICIDAL AND PROTECTIVE ELECTRICAL COATINGS
WATER STREET • OSSINING • NEW YORK

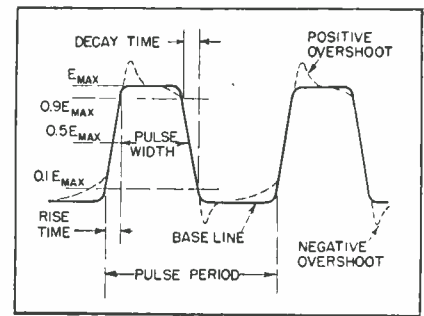

FIG. 1—Principal features of pulses show times to be measured

the pulse is symmetrical, that is the rise and decay times are substantially equal, an 'elliptical sweep can be used'. However when the pulse has a very steep rise or a very rapid decay, the pulse itself can be used as the sweep to obtain accurate time measurements.

Basic System of Measurement

Figure 3 shows two alternate arrangements of the measuring equipment. The trigger used to initiate the test pulse may be derived from a free running trigger generator or from a frequency divider driven by a high-frequency source. In the former case a pulsed oscillator is required to provide the measuring frequency. In the latter instance the high-frequency oscillator from which the trigger is derived may be the source of the measuring frequency.

The pulse whose rise time is to be investigated is connected to the

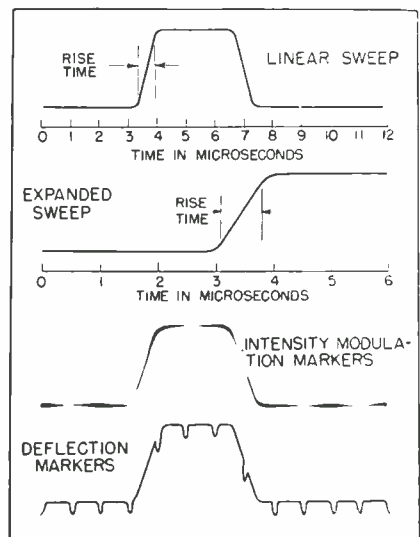
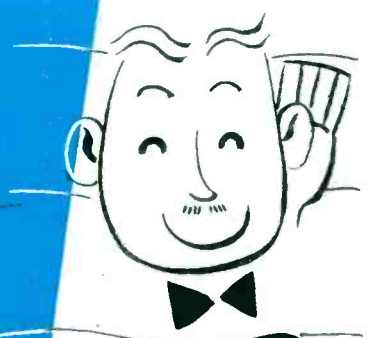
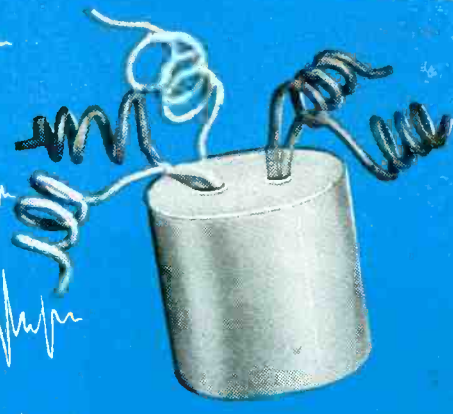
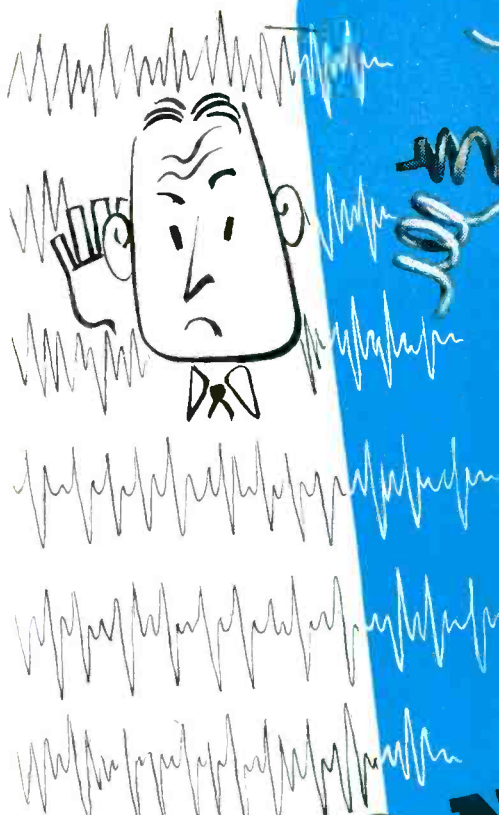
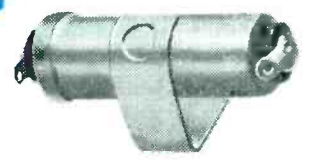
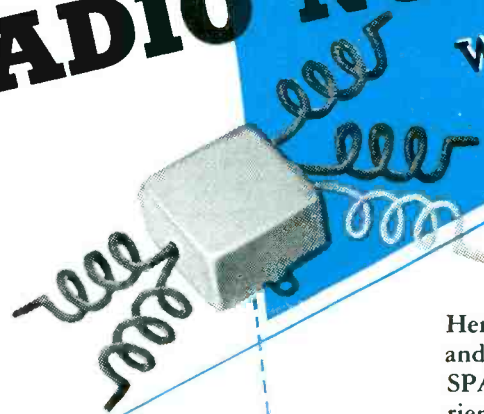
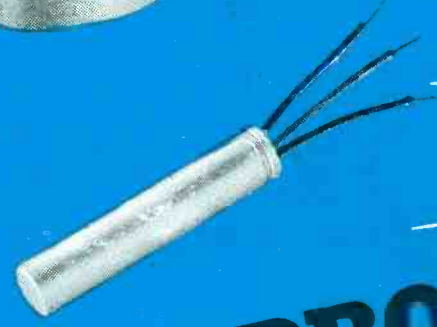

FIG. 2—Several techniques are frequently used to measure pulse rise or decay time. The top two methods depend on a linear sweep for a time base; the bottom two use time interval markers



RADIO NOISE-PROOFED WITH C-D QUIETONES



More and more, electrical appliance customers are asking – "Will it cause radio interference?" And in the answer to that question lies the secret for many more sales of your products.

Here at Cornell-Dubilier you'll find *your* answer – in a modern and complete laboratory, devoted to RADIO NOISE AND SPARK SUPPRESSION DEVICES – the industry's most experienced engineers – the thirty-seven-year C-D background, unequalled in the capacitor field. They're all at your disposal – NOW. Whether you want to Radio Noise-Proof equipment already in production – or if you're engineering a new product from the ground up – C-D Quietones will do the job efficiently and permanently. **YOUR INQUIRIES ARE INVITED.** Cornell-Dubilier Electric Corporation, Dept. K-9, South Plainfield, New Jersey. Other large plants in New Bedford, Worcester and Brookline, Mass., and Providence, R. I.

Make Your Products More Saleable with C-D Quietone Radio Noise Filters and Spark Suppressors

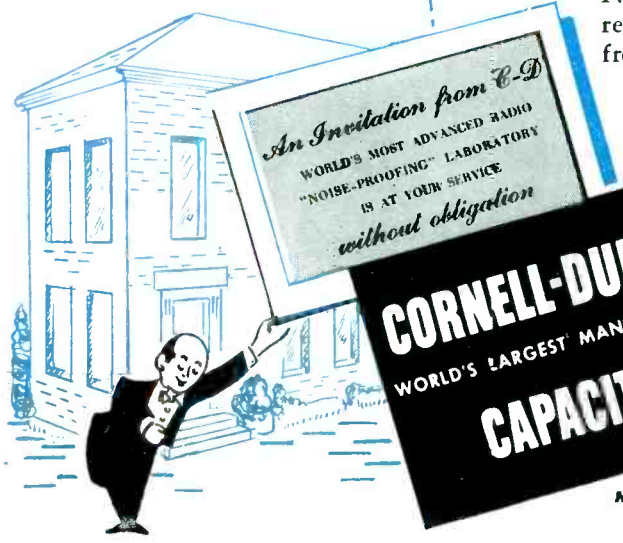

CORNELL-DUBILIER
WORLD'S LARGEST MANUFACTURER OF
CAPACITORS

MICA • DYKANOL • PAPER • ELECTROLYTIC



1910 1947

TEAMED FOR PERFECT HEARING COMFORT

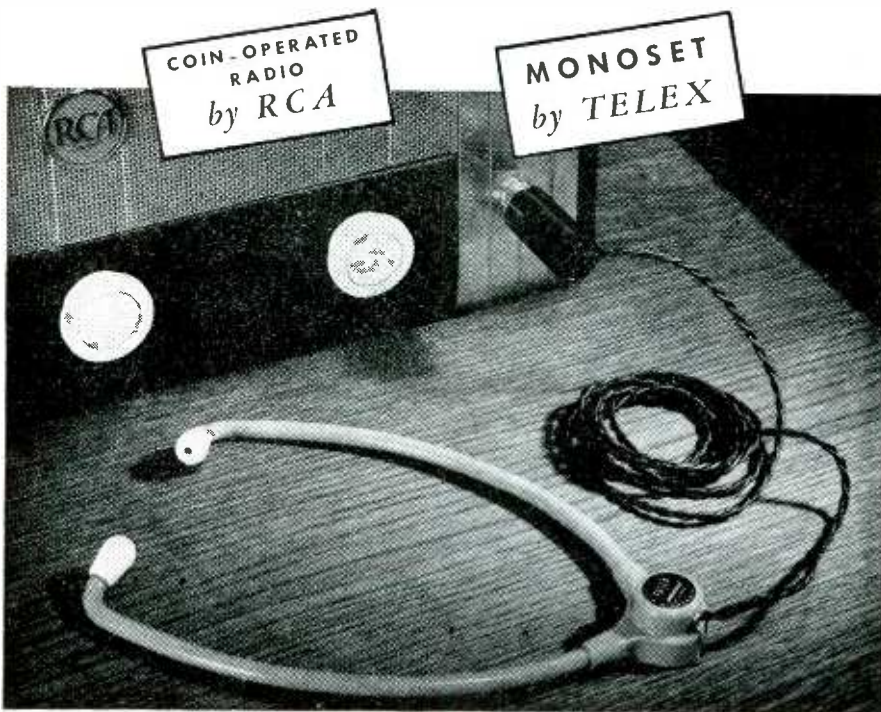

When RCA engineers checked headphones for their new hotel "coin-operated" radio, they quickly found what they wanted in the New TELEX Monoset. Today it's standard equipment on this RCA hotel model.

Take a "tip" from RCA and whenever comfortable hearing, fidelity and ease of use are needed for your sound equipment, specify the TELEX Monoset. It replaces old style, uncomfortable headphones. Light weight (1.2 oz.). Worn under the chin. Rugged Tenite plastic construction.

Write Department AA for information and quotations. We'll be happy to show you how the TELEX MONOSET can become part of your team for perfect hearing comfort.

Canadian Distributors:
Addison Industries, Ltd., Toronto

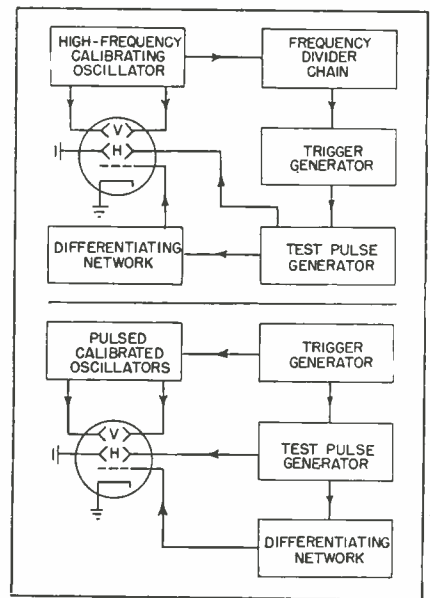

FIG. 3—The measuring technique can be accomplished by several arrangements of equipment

horizontal plates of the cathode-ray tube. Thus the pulse provides the sweep. The pulse is simultaneously passed through a differentiating network whose output is connected to the cathode-ray tube grid or cathode.

Before the pulse begins to rise, the beam of the cathode-ray tube is stationary and appears as a bright spot marked A in Fig. 4A. (assume for the moment the calibrating oscillator is not operating). As the

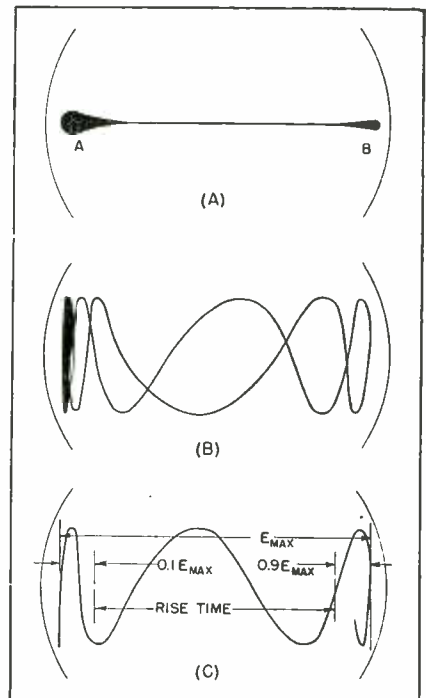

FIG. 4—Appearance of traces produced on oscilloscope during measurements

THREE THINGS YOU SHOULD KNOW

about

Federal Selenium Rectifiers

FOR CONVERTING AC TO DC

1. THEIR DEVELOPMENT. The Selenium Rectifier was developed by IT&T — and was first manufactured in this country by Federal, in 1938. For the past 9 years Federal has continually improved and perfected the Selenium Rectifier — has developed *every major advance* in its design and construction. As a result, the Federal Selenium Rectifier is now the most efficient, compact, and economical means of converting AC to DC.

2. THEIR APPLICATION. Federal has pioneered the application of the Selenium Rectifier to *new jobs* in practically every field of the industry. From milliwatts to kilowatts — wherever you need DC from an AC source — you can now save space, time, and money with Federal Selenium Rectifiers.

3. THEIR DESIGN. These features make Federal your best buy in Selenium Rectifiers:

Center-Contact Construction — permits entire stack to be permanently protected against corrosion.

Higher Voltage Plates — give extra breakdown strength, extra dependability.

Aluminum Plate Designs — for use where extremely light weight is desired.

Long Life — constant use in all types of applications prove Federal's superiority and long life.

Available in Wide Range of Standard Ratings — for information, write to Federal today. Dept. F 113.

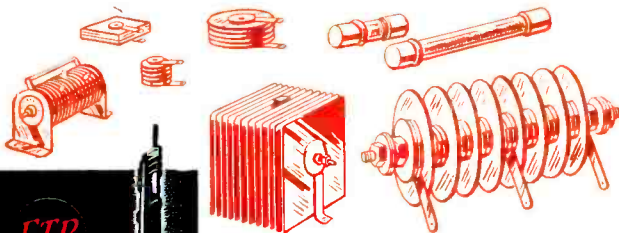
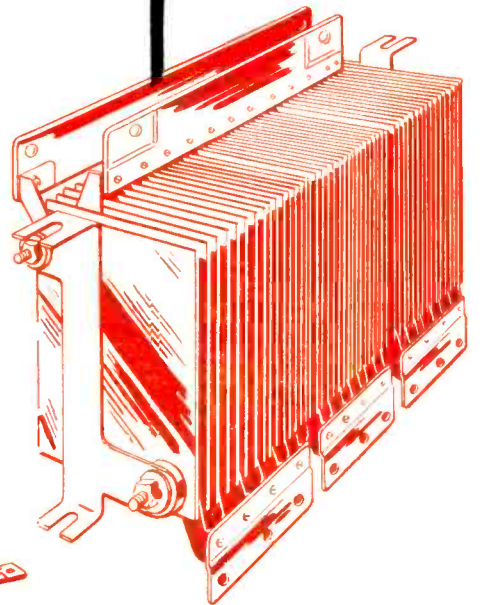
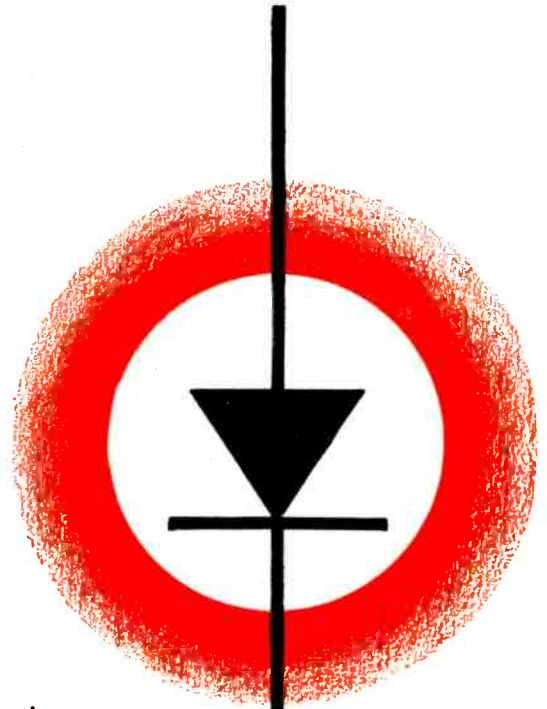

Federal Telephone and Radio Corporation

SELENIUM and INTELIN DIVISION, 1000 Passaic Ave., East Newark, New Jersey

KEEPING FEDERAL YEARS AHEAD... is IT&T's world-wide research and engineering organization, of which the Federal Telecommunication Laboratories, Nutley, N. J., is a unit.

In Canada: — Federal Electric Manufacturing Company, Ltd., Montreal.

Export Distributors: — International Standard Electric Corp., 67 Broad St., N. Y. C.

MAKE SOLDER BONDS



**Right—
Tight—
Precise**

Photo courtesy Statham Laboratories, Los Angeles

use . . .

KESTER CORED SOLDERS

- Kester Cored Solders are correctly compounded to provide permanent performance and maximum precision. They're made to withstand wear and tear, and they fit your soldering operation like a hand-tailored glove.
- What's more, Kester Cored Solders cut the hard work out of soldering. They are applied quickly and easily—in one simple operation. Self-contained fluxes are released as the solder is applied. The resulting solder bonds are tough, tight and dependable.
- Kester Cored Solders are of the highest quality and unvarying uniformity—the result of Kester's nearly half a century of practical experience and exhaustive research.
- Kester Rosin-Core Solder, for electrical connections, and Kester Acid-Core Solder, for general work, are both available in a wide range of strand and core sizes. The correct solder, always, for any soldering job.
- Consult Kester Engineers without obligation for aid in the solution of any soldering operation. There is no obligation!

KESTER SOLDER COMPANY

4204 Wrightwood Avenue, Chicago 39, Illinois

Eastern Plant: Newark, N. J.

Canadian Plant: Brantford, Ontario



KESTER
Cored Solders
STANDARD FOR INDUSTRY

pulse voltage rises, the spot sweeps across the screen at a velocity proportional to the rise time and for a distance proportional to the peak voltage and deflection sensitivity. The pulse eventually reaches the peak voltage and remains at this value for a while causing the bright spot at B, after which it sweeps back to the starting point A until the next cycle. Both rise and decay times contribute to the total deflection while the periods of relatively constant amplitude cause only bright spots. This fact should be contrasted with the other methods mentioned above wherein rise and decay times occupy only a very small percentage of the screen trace.

Now suppose the marker oscillator, which is synchronized with the initiating trigger, is connected to the vertical plates of the cathode-ray tube. This connection is analogous to the familiar use of sine-waves for sweep calibration. Figure 4B shows a possible result. The display in this figure still has limited utility because it contains both the forward and return traces superimposed, which may prove confusing. Blanking of the return trace is the purpose of the differentiating circuit.

It is well known that a pulse passed through an R-C circuit of proper time constant (sufficiently short compared with the pulse width) results in a pair of pulses, one positive and one negative. The times of occurrence of the pair of pulses coincide with the rise and decay times of the input pulse. If the output of the differentiating cir-

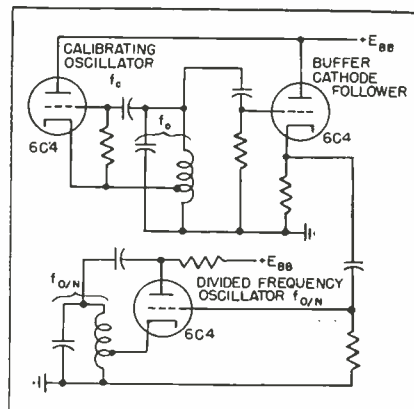

FIG. 5—A synchronized frequency dividing oscillator can be used to obtain a pulse triggering signal co-ordinated with the deflection signal.

THERMOTECHNICS*

Gives Armstrong Baby Incubators

TROUBLE-FREE TEMPERATURE CONTROL . . .



**FLANGE HEAD
THERMOSWITCH
CONTROL**

Used in Armstrong Incubators

*The Fenwal method of analyzing and coordinating process requirements, heating means, control devices and product design to insure best over-all performance of the complete thermal-control system.

Temperature control in a baby incubator must be fool-proof, precise and absolutely dependable. The degree of temperature variance permissible is limited . . . the control device must operate with safety in high concentrations of oxygen where often the baby's life is at stake . . . and it must be trouble-free. Failure to respond instantly and correctly can be fatal.

Fenwal and Armstrong Company engineers collaborated on the application of Thermotechnics to the Armstrong Baby Incubator in order to attain the best temperature control conditions. After extensive tests and experimentation, the Flange Head THERMOSWITCH Control was selected.

The finished job is an integrated unit . . . coordinating product design with heat source and temperature regulation to an outstanding degree. Temperature variance is held within specified limits . . . trouble-free service assured with a Fenwal THERMOSWITCH Control.

*T. M. Reg. U. S. Pat. Off.

THE PROOF'S IN THE PERFORMANCE

After 26,000 hours constant operation, Fenwal THERMOSWITCH Controls continue to give accurate and dependable service in the Gordon Armstrong Baby Incubators.

Gordon Armstrong, president, states: "The Fenwal THERMOSWITCH was selected because we considered it the best available. We still think it is after some three years of use."

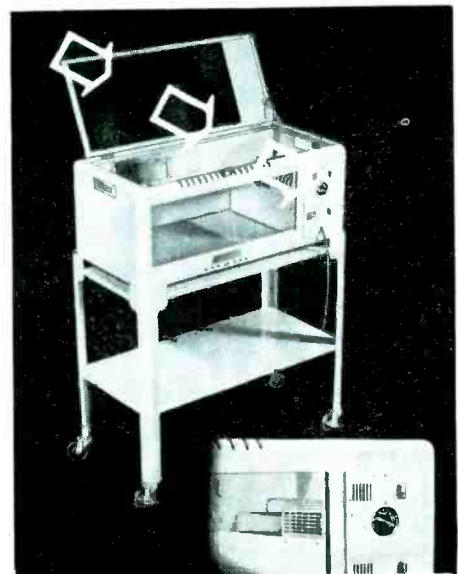

ARMSTRONG X-4 BABY INCUBATOR

Arrow points to Control Dial of Fenwal THERMOSWITCH Control. THERMOSWITCH Controls in Armstrong Incubators are helping save babies' lives throughout the United States, Canada, Central and South America and many countries throughout the world.

THERMOTECHNICS can solve your temperature control problem. Send for complete details and your copy of the Fenwal Catalog.

Fenwal

THERMOTECHNICS, through THERMOSWITCH Controls, is providing accurate, trouble-free temperature control in many other applications, including aircraft fire detection equipment, electrical appliances, ovens, vulcanizers, food dehydrators, etc.

FENWAL INCORPORATED

43 PLEASANT STREET

A S H L A N D , M A S S .

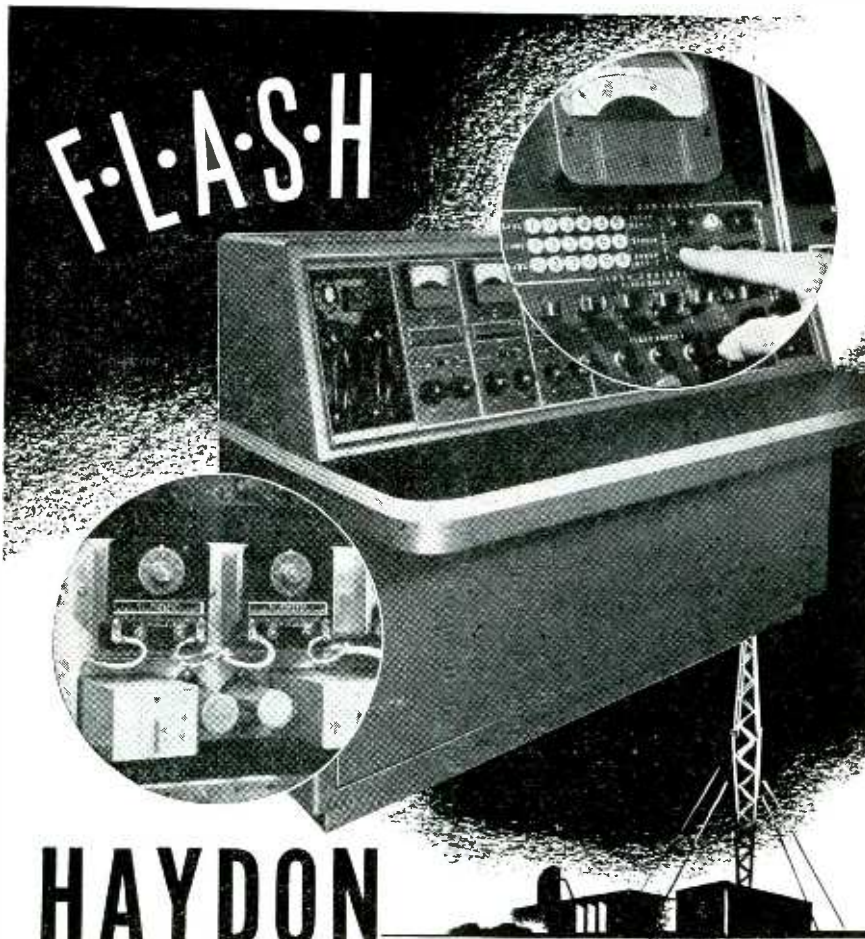

HAYDON

puts them ON THE AIR

Western Electric uses *Haydon Automatic Time Delay Relays* to actuate Flash Announce signal circuits in this new relay type Program Dispatching Unit for radio broadcasting.

Operating efficiency is the keynote of this Dispatching Unit, enabling the master control operating staff to handle successive multiple switching operations on a split second basis with speed and accuracy.

Switching functions scheduled to occur simultaneously are preset beforehand and a *Haydon Interval Timer*, adjustable over a 60 second interval, operates delayed circuit switching, enabling the operator to spread out his starting of these functions.

This and many other Haydon applications are accounting for greater timing accuracies throughout industry. If it's about time, write for free descriptive engineering catalog featuring Haydon timing motors and devices.

WRITE HAYDON, 2400 ELM STREET, TORRINGTON, CONNECTICUT

HAYDON

MANUFACTURING COMPANY, INC.

TORRINGTON

CONNECTICUT

HARNESS TIME TO

YOUR PRODUCTS

SUBSIDIARY OF GENERAL TIME INSTRUMENTS CORPORATION

cuit is connected to the intensity grid of the cathode-ray tube, the positive pulse will cause brightening of the trace and the negative pulse dimming. When the grid is initially biased near cutoff, then brightening will result for a time corresponding to the rise time of the test pulse. (If a negative test pulse is used the output of the differentiating circuit should be connected to the cathode of the cathode-ray tube to observe the rise time). The trace will then appear as in Fig. 4C. In some applications it has proved desirable to square the tops of the intensifying pulses in order to reduce the tendency toward defocusing of the trace.

If the frequency of the calibrating oscillator is known, the rate of rise can be studied between any two points along the rise characteristic by counting the number of cycles of the calibrating oscillator between them.

To observe the decay time of the test pulse, the output of the differentiating circuit may either be inverted or connected to the cathode of the cathode-ray tube. (A negative test pulse would require connection to the intensity grid to observe the decay time.)

Design Considerations

There are several design considerations which affect the choice of equipment. Because the rise time of a pulse may be exceedingly fast (for example 0.05 microsec), a cathode-ray tube employing high accelerating voltages should be used in order to obtain usable brilliance, especially if a pulse of low repetition frequency is to be studied. Obviously the highest feasible value of pulse repetition rate should be used wherever possible. High accelerating voltages required for good brilliance are usually accompanied by lower deflection sensitivity although new tubes with 20,000 volts of accelerating potential and high deflection sensitivity are available commercially². Thus a fairly large peak pulse voltage is needed to secure sufficient deflection. If small pulses are to be measured, a pulse amplifier is essential but usually will distort the rise time of extremely fast pulses. This defect is common to most

Just roll it open!

SIMPSON Model 260 Volt-Ohm Milliammeter

*...with Roll Top Safety Case**

• The world's finest high sensitivity set tester certainly deserves the best in carrying cases. So we decided to give it just that by *building* the tester into the case to make an integral unit of case and instrument. Here's how we do it: we take the standard Model 260, place it inside a housing of heavily molded bakelite, and permanently fasten it there. Instrument and case become one unit. Beneath the instrument is a compartment for test leads. Over the face of the instrument a roll top (of molded bakelite, too) slides up to open, down to close, the case. With a flick of the

finger you roll it up and out of sight and the instrument is ready to carry, and fully protected. With the Roll Top Safety Case you cannot leave your carrying case behind. It is never in the way. And you have *constant, important protection to your 260 from damage, whether in use or not.*

Just remember this fact, always: You cannot touch the precision, the useful range, or the sensitivity of Simpson Model 260 in any other instrument of equal price or in some selling for substantially more.

**The regular Model 260, without Roll Top Safety Case, is always available, of course.*

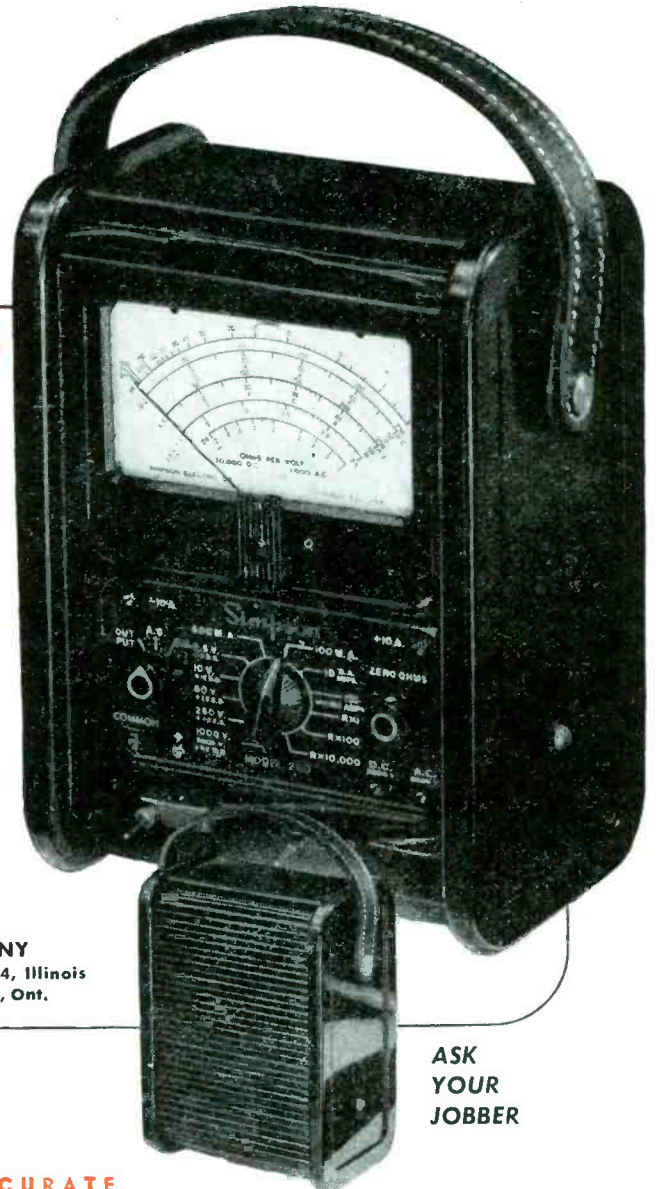

Simpson 260, High Sensitivity Set Tester for Television and Radio Servicing

At 20,000 Ohms per volt, this instrument is far more sensitive than any other instrument even approaching its price and quality. The practically negligible current consumption assures remarkably accurate full scale voltage readings. D.C. current readings as low as 1 microampere and up to 10 amperes are available.

Resistance readings are equally dependable. Tests up to 20 megohms and as low as 1/2 ohm can be made. With this super sensitive instrument you can measure a wide range of unusual conditions which cannot be checked by ordinary servicing instruments.

Model 260—Size 5 1/4" x 7" x 3 1/8" \$38.95

Model 260, in Roll Top Safety Case—Size 5 3/8" x 9" x 4 3/4" \$43.75

Both complete with test leads

Volts D. C. (at 20,000 ohms per volt)	Volts A. C. (at 1,000 ohms per volt)	Output	Milliamperes D. C.	Microamperes D. C.	Ohms
2.5	2.5	2.5 V.	10	100	0-2000 (12 ohms center)
10	10	10 V.	100		0-200,000 (1200 ohms center)
50	50	50 V.	500		0-20 megohms (120,000 center)
250	250	250 V.		Amperes	
1000	1000	1000 V.		D. C. (5 Decibel ranges: -10 to +52DB)	
5000	5000	5000 V.		10	

SIMPSON ELECTRIC COMPANY
 5200-5218 West Kinzie Street, Chicago 44, Illinois
 In Canada, Bach-Simpson Ltd., London, Ont.

Simpson
 INSTRUMENTS THAT STAY ACCURATE

ASK
 YOUR
 JOBBER

Come to **ACRO** for

ROLLING SPRING SWITCHES

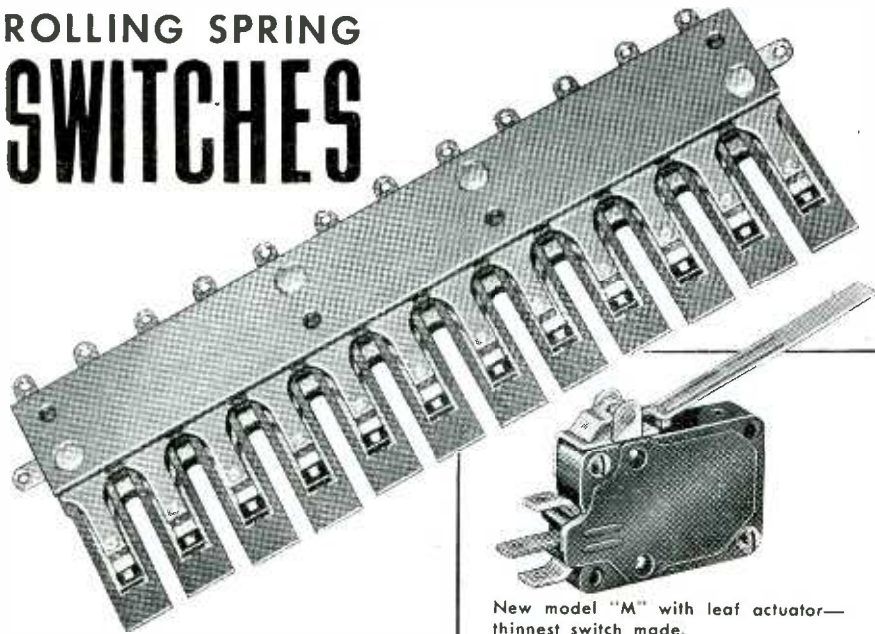

...precision
engineered
TO FIT THE JOB

Let us engineer and build your Snap-Action Switches to meet the engineering requirements of your application. ACRO Switches are also built in gangs (as shown above) in any number for your economical assembly.

All ACRO Snap-Action Switches are designed with the famous patented Rolling Spring principle that assures more POSITIVE action, longer life, and greater economy. Single pole or multiple pole. Normally open, normally closed, or double throw. Variety of actuators. Fully enclosed and open blade types. Operating characteristics to suit your needs. Ratings: Up to 15 Amps, 125

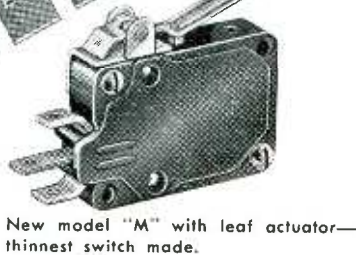

New model "M" with leaf actuator—
thinnest switch made.

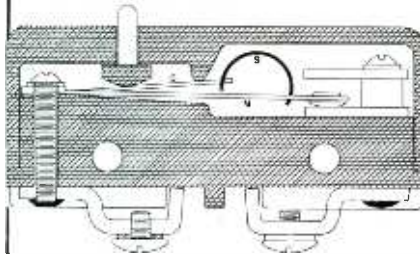

Cross section of patented Rolling Spring
construction in fully enclosed type.



Typical 2 pole open blade type. Small,
compact, and positive.



Open Blade Model "M" for limited
space and low cost.

Volts A.C. Send blueprints and
details for quicker action.

ACRO ELECTRIC COMPANY
1316 SUPERIOR AVENUE, CLEVELAND 14, OHIO

methods of rise time measurement.

It is, of course, not essential that the measured pulse be connected to the horizontal plates of the cathode ray tube. The vertical plates may be preferred.

The calibrating oscillator may take several forms; the commonest is a free running oscillator operating at a fairly high frequency. (For example, a 100 mc oscillator will give 10 marker cycles when observing a pulse with a 0.1 microsec rise time, whereas a 10 mc oscillator will give 10 cycles with a pulse of 1 microsec rise time.) The use of a chain of synchronized sinewave oscillators³ makes it possible to obtain division from 100 mc down to trigger frequency, with each oscillator providing a frequency division of ten to one, or better yet, five to one. A fundamental circuit diagram of a suitable synchronized sinewave frequency dividing oscillator is shown in Fig. 5. It is also possible to utilize a pulsed oscillator as a source of calibrating frequency⁴.

Numerous variations of the principles outlined in this paper are possible. No attempt has been made to show particular circuit arrangements as these details will depend on the types of pulses to be measured and the available laboratory equipment. Also the equipment arrangement for a laboratory measurement will differ considerably from that for measuring and standardizing production pulse generators.

(1) Allan Easton, Measuring Pulse Characteristics, *ELECTRONICS*, p 150 Feb 1946.
(2) I. E. Lempert and R. Feldt, The 5RP Tube, Intensifier Type CR Tube for High Voltage Operation, *Proc Inst Radio Engrs*, p 432 July 1946.
(3) C. W. Carnahan and H. P. Kalmus, Synchronized Oscillators as FM Limiters, *ELECTRONICS*, p 109 Aug 1944.
(4) Allan Easton, Pulse Modulated Oscillator, *ELECTRONICS*, p 125 March 1947.

SURVEY OF NEW TECHNIQUES

INFRARED RADIATION to wavelengths as long as 30,000 Angstroms is recorded on a spectrograph developed at Northwestern University under Dr. R. C. Nelson's direction. Mirrors mounted on precision bearings disperse an infrared ray into its component wavelengths and passes it across a Cashman cell. The electrical current so generated is amplified and recorded on a 10-inch

In the electronic industry

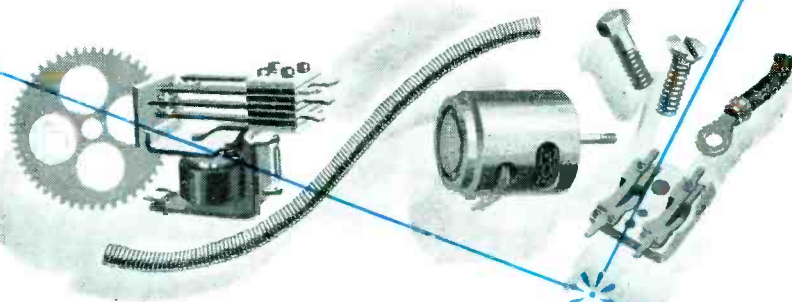

WHO buys these products?



These are not basic electronic components such as tubes, resistors, coils and capacitors for which the market is well known and established.

These are products such as precision gears, flexible shafting, sensitive relays, snap action switches, fractional hp motors, fasteners, etc. Products that, although not basic electronic components, are vitally important to, and used in volume in the manufacture of electronic equipment, components and controls.

Although it is known that the market for these products is large in volume, it is not so well known *who buys these products.*

Products that are not basic electronic components but which are vitally important in the manufacture of electronic equipment and components.

electronics *determined to find out . . . and did . . .* by asking every ninth subscriber whether he directed or influenced the purchase of these products.

the results of this subscriber study

defining the buying scope of ELECTRONICS' circulation in relation to these products is now available. A request to your local ELECTRONICS' representative will bring you a factual analysis of "What They Buy" — from drafting equipment to telemetering systems;

"Who Does the Buying" — an amazing galaxy of research, engineering and miscellaneous titles throughout the industry; and, based on a percentage of purchasing power, a determination of your ELECTRONICS advertising budget. Study it carefully and use it as a valuable guide to the electronic market for these products.

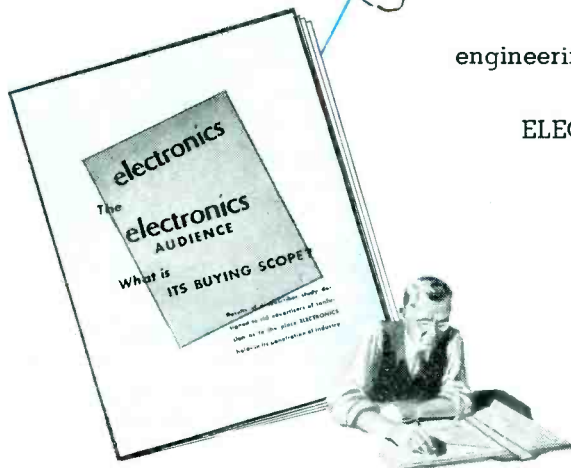

electronics

DESIGN • PRODUCTION • USE
ABC Established 1930 APB

330 W. 42nd St. • A McGRAW-HILL PUBLICATION • NEW YORK 18, N. Y.

ENGINEERING SKILL means

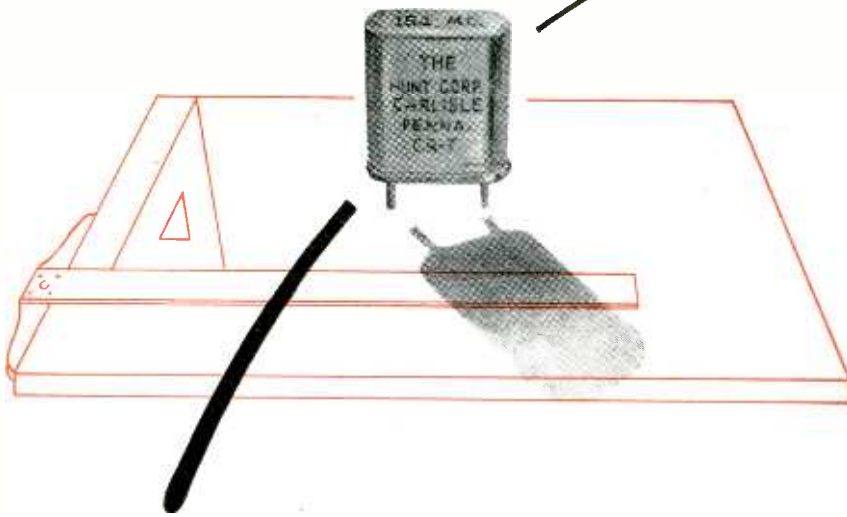

High Stability CRYSTALS

From start to finish . . .

. . . all along the line . . . the stability of your crystal and the stability of your set . . . depend upon engineering skill.

HUNT supplies the experienced crystal technicians, modern manufacturing methods and inspection skill which assure high stability, close tolerance HUNT crystals to give you better results from your set.

Before you design your set, get together with experienced HUNT Engineers. They can help you select the right Crystal to give better results from your set. Write today.

THE **H**unt **CORPORATION**



Pacemaker in Stability

CARLISLE, PA.

ELECTRON ART

(continued)

graph a quarter of a mile long. This infrared region is of interest to astronomers in locating relatively cold bodies, studying atmospheres of planets, and gases of the Sun, and to physicists in studying radiations from atoms.

TRACER TECHNIQUES using radioactive isotopes are made more effective by magnetically focusing an image of the radiation given off by the test material onto a photo-

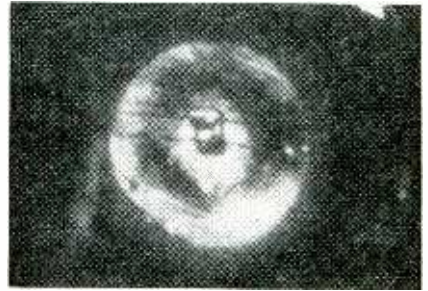

Tracer micrograph shows distribution of radioactive isotopes within a thin layer of test material

graphic plate. The technique is being used at the National Bureau of Standards by L. Matron in cooperation with P. H. Abelson of Carnegie Institute. The tracer micrographs provide greater resolution in localizing positions of radioactive particles and thus enable their course in biological and chemical actions to be more accurately followed.

TRUE TEMPERATURES of Alnico and Alcomax permanent-magnet alloys are measured in the research department of Messrs William Jessop and Sons (Sheffield, England) by a simple photoelectric pyrometer developed by T. Land and H. Lund. A single lens of 30-cm focal length and 4-cm aperture projects an image of the molten surface on a 2.5-cm diameter selenium barrier-layer photoelectric cell behind a 1-cm aperture. Light baffles in the mounting tube exclude ambient light. The photocell operates a 500-ohm 15- μ a microammeter. In calibrating the instrument against an immersion type pyrometer, the spectral emissivities of the molten surfaces were calculated and introduced into the photopyrometer by means of a variable resistance shunt. For melts having clean surfaces, the instrument provides absolute temperatures within ± 10 C.

HEAVY ARTILLERY IN WAR ON T. B.

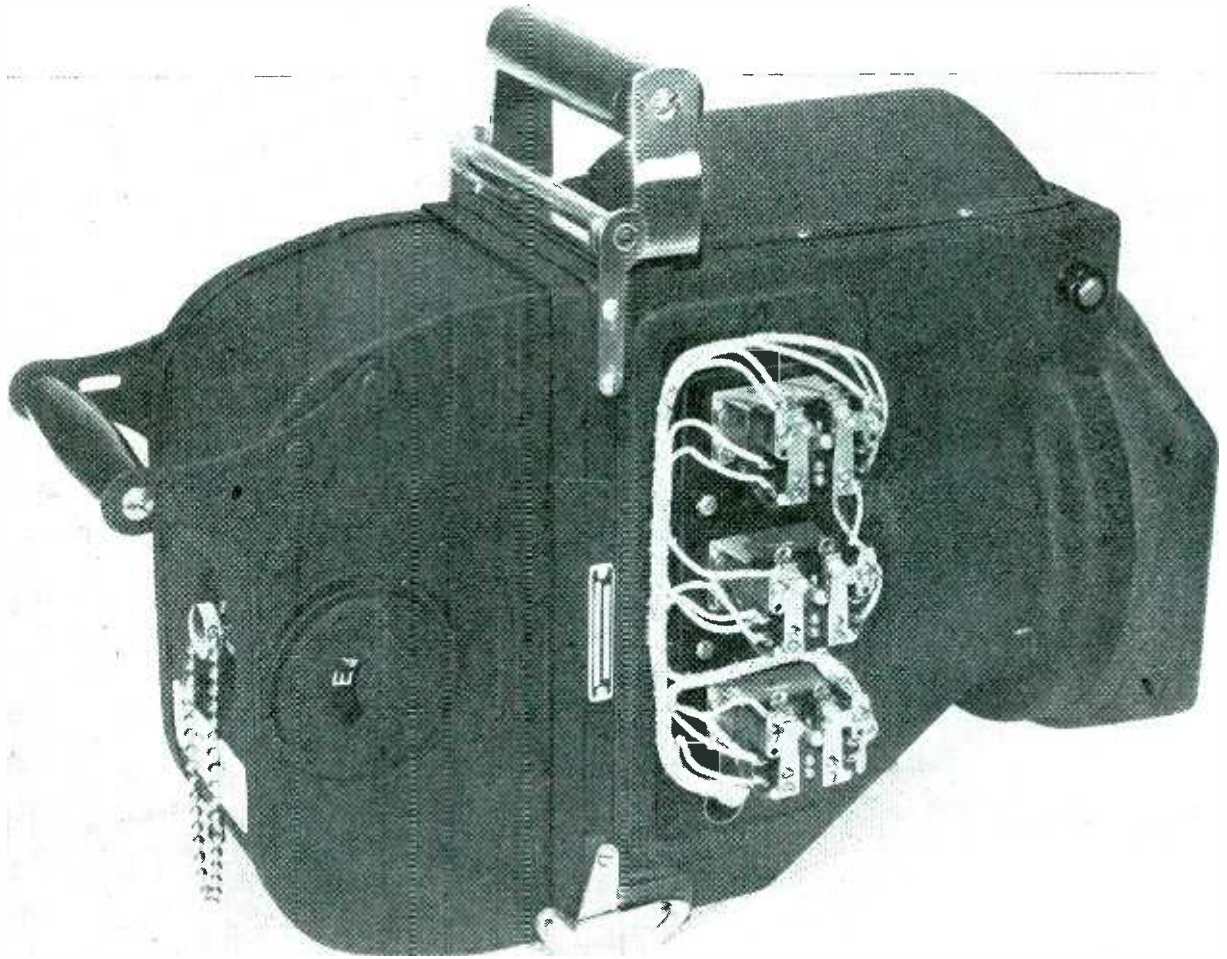

ROCKBESTOS Firewall Hookup Wire

Insulated with high-dielectric synthetic tapes and a "firewall" of impregnated felted asbestos, and covered with color-coded lacquered glass braid, this heat, flame and moisture resisting wire may be operated *continuously* at rated voltage under 125° C. without baking out. Widely used in airborne, marine, ground and mobile communications systems, electronic devices and compact apparatus in which dependable performance is essential. Also ideal for small motor, coil, transformer and dynamotor leads. Sizes 22 to 4 AWG in 1000 volt rating and 12, 14 and 16 AWG in 3000 volt rating.

One of 125 different constructions designed by Rockbestos for severe operating conditions in ratings ranging from 300 to 5000 volts.

In the battle against tuberculosis the Fairchild Fluoro-Record Camera pictured above has recorded the condition of hundreds of thousands of lungs. Mounted on X-Ray equipment, it is used by the U. S. Public Health Service and other public and private organizations for mass screenings. By this new method the automatic 70 mm camera photographs the chest as reflected on a fluoroscopic screen, and with 400 single negatives per roll of film hundreds of permanent records can be made daily.

Fairchild wires these cameras with Rockbestos Firewall Hook-up Wire for several good reasons. They liked its performance record in their military cameras. They needed a small-diameter wire with high dielectric strength that could withstand the heat generated by mass radiography — Underwriters' approved for operation at 90° C. — and they had to be sure that it wouldn't dry out or bake brittle and would have ample resistance to aging, moisture and flame.

This is but one of hundreds of cases in which manufacturers of electrical products ranging from appliances to precision instruments protect performance with *permanently insulated* Rockbestos wires, cables and cords. 125 different standard types to select from. For recommendations or engineering assistance, write to nearest district office or:

ROCKBESTOS PRODUCTS CORPORATION, 451 Nicoll St., New Haven 4, Conn.

ROCKBESTOS RESEARCH



Solves Difficult Wire Problems

NEW YORK BUFFALO CLEVELAND DETROIT CHICAGO PITTSBURGH ST. LOUIS LOS ANGELES OAKLAND

WHATEVER THE PRECISION MADE TUBE

ALUMINUM
ALLOY
INSTRUMENT
TUBING TO EXACT
SPECIFICATIONS

PRECISION
PREFORMED
TUBING TO
YOUR NEEDS

METAL
SHIELDED WIRE
FOR 1001
ELECTRONIC
USES

PRECISION CAN MAKE IT FOR YOU!

You name your needs in accurately drawn seamless brass, copper, nickel, aluminum or other non-ferrous metal tubing and we have your answer. Every inch of Precision-made tubing is produced to exact requirements made possible by our special annealing process. Tubing with outside diameters ranging from 0.375" to 0.010" with a wide range of wall thicknesses.

POINTER TUBING to the most exacting specifications and also formed to your own particular needs. Made of various alumi-

If you are responsible for specifying small, non-ferrous metal tubing that must meet exacting specifications at all times, you need this new booklet of Precision Tubing and how it should be used. Write for your free copy today.



num alloys in any wall thickness down to one and one-half thousandths (0.0015")

PREFORMED TUBING held to extremely close tolerances as specified by your engineering figures.

METAL SHIELDED WIRE, a new and different product performance-proved for its superiority. Consists of an inner conductor, dielectric and seamless metal tube, forming a coaxial pair of conductors. Shield and conductor remain coaxial even when formed into intricate shapes.

NEW PRODUCTS

(continued from p 142)

Pickering model 120M cartridges. Arm resonance is less than plus or minus 1 db over the audio range from 40 to 15,000 cycles and provides a pressure of 22 grams. The arm is 15½ inches long and weighs about 10 ounces.

Miniature Tube VTVM (14)

ALLIED LABORATORY INSTRUMENT, INC., 355 West 26th St., New York 1, N. Y. The model 730 vacuum tube voltmeter incorporates miniature



tubes, an r-f probe with flat response to 120 mc, metal film resistors, and an accuracy of plus or minus 3 percent. The unit is light, small and low in price.

F-M and Television Antennas (15)

JFD MANUFACTURING Co., Inc., 4117 Ft. Hamilton Parkway, Brooklyn 19, N. Y. A new line of f-m and television antennas, together with wall insulators for holding the

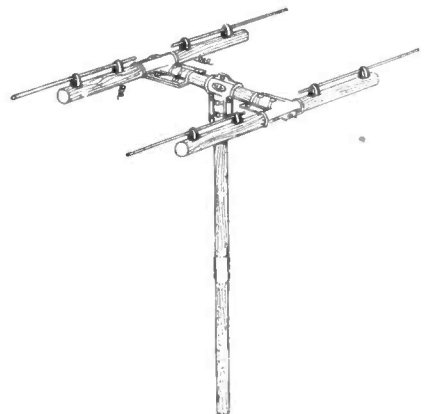

PRECISION TUBE CO.

SPECIALISTS IN ACCURATELY DRAWN TUBING AND METAL SHIELDED WIRE
Factory: 3824-26-28 TERRACE STREET · PHILADELPHIA, PA.

BRANCHES IN ALL PRINCIPAL CITIES



SAVE "SILVER" DOLLARS with General Plate Laminated Metals

(Silver or precious metal bonded to base metal)

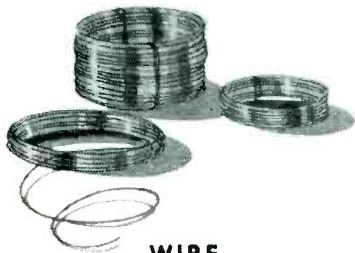

WIRE

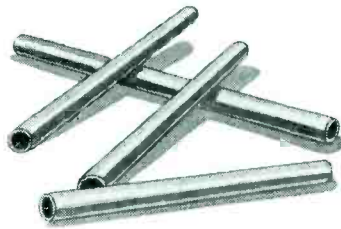

TUBE

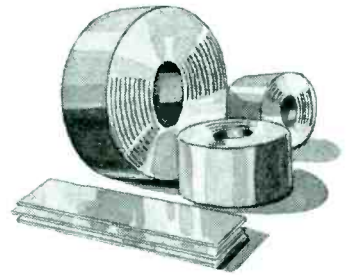

SHEET

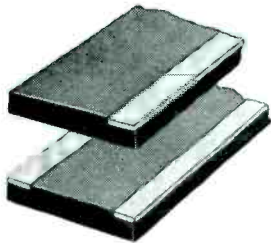

INLAY METALS

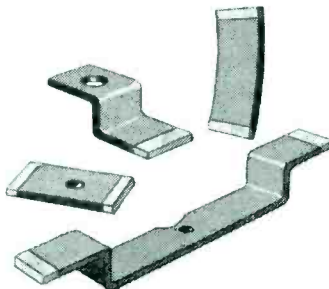

CONTACTS

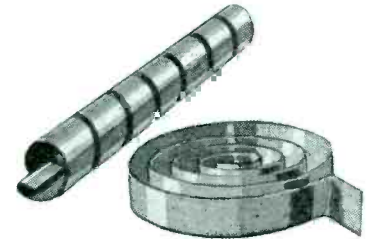

THERMOSTAT METALS

There are many reasons why General Plate Laminated Metals save you money... especially during a high silver market. First — by giving you precious metal only where you need it, they reduce the high cost of today's precious metals. Second — they increase performance because they have higher electrical conductivity, high corrosion resistance, greater strength, and long wearing properties. Third

— they reduce production costs because General Plate Laminated Metals provide ease of fabrication, are more workable, easy to solder or braze.

General Plate Laminated Metals are available in sheet, wire and tube... inlaid or wholly covered... or as fabricated parts. Write for information on these money-saving materials today.

GENERAL PLATE DIVISION

of Metals & Controls Corporation

ATTLEBORO, MASSACHUSETTS

50 Church St., New York, N. Y.; 205 W. Wacker Drive, Chicago, Ill.; 2635 Page Drive

Altadena, Calif.



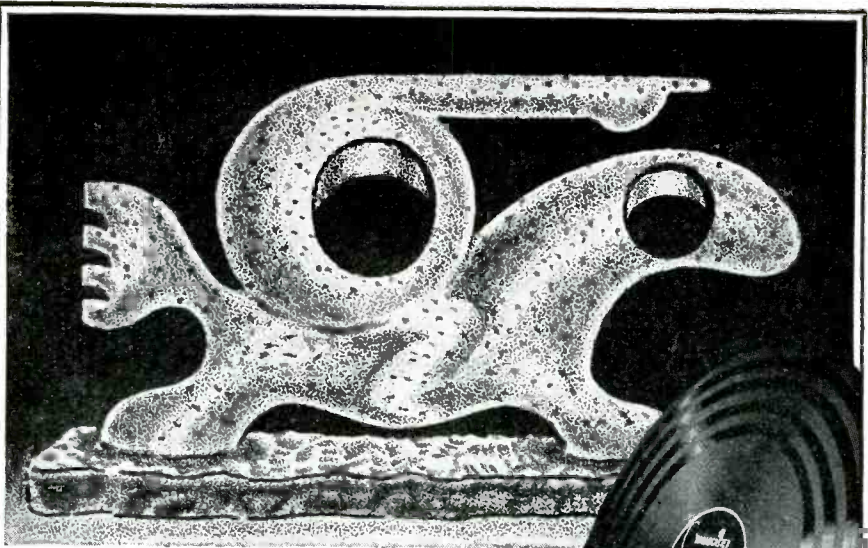

**Masterpiece of
Sculpture? . . .
We don't know . . .
But we do know
what makes a Masterpiece
in a RECORDING**

Try this easy 4 point test to prove that Soundcraft offers you the greatest potential for a recording masterpiece.

1. Cut several unmodulated grooves in any competitive blank disc. Make certain cutter is completely disconnected.
2. Take a Soundcraft blank and repeat step No. 1.
3. Now, play back the Soundcraft cutting with bass knocked out, full highs on, and volume high. Set VU meter pad and note average reading.
4. Play competitive disc using same settings.

Soundcraft will be quieter, have less crackle and the meter will be steadier.

In our book that's a long step toward recording a Masterpiece of sound reproduction.



• *The 'Broadcaster'*
8" 10" 12" 16"

• *The 'Playback'*
8 1/2" 8" 10" 12" 16"

• *The 'Audition'*
4 1/2" 8" 10" 12" 16"

• *The 'Maestro'*
12" 13 1/2" 17 1/2"

REEVES SOUNDCRAFT CORPORATION

10 EAST 52 STREET

NEW YORK 22, N. Y.

transmission line in place, have been announced. A folder describing the equipment in detail is available.

**Subminiature Electrometer
Tube (16)**

VICTOREEN INSTRUMENT Co., 5806 Hough Ave., Cleveland 3, Ohio. Type XV-41 subminiature electrometer tubes have incorporated new design features reducing mi-



crophonics to a minimum. Filament voltage is 1.25 v; filament current, 10 ma; grid current, less than 10^{-15} amp; grid resistance, greater than 10^{15} ohms.

Screen Wall Counter (17)

RADIATION COUNTER LABORATORIES, 1451 East 57th St., Chicago 37, Ill. The Libby screen wall counter can be used to measure soft radiation

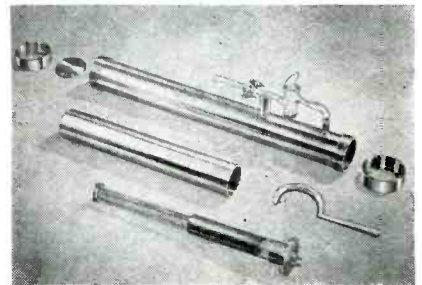

from a sample that can not be obtained as a suitable gas, or any radiation from a sample of extremely low specific activity that is available in large quantities. All types of particle radiation, alpha particles, beta particles and conversion (Auger) electrons can be counted.

F-M and A-M Tuner (18)

BROWNING LABORATORIES, Inc., Winchester, Mass., has recently developed an f-m and a-m tuner, Model RJ-14, in rack panel style for com-

CONDENSERS...

... BASIC TUNING UNITS

These transmitting condensers should be the basic tuning units of your transmitter designs.

Compact assembly, steatite insulation, sturdy construction, and conservative ratings will enable National condensers to prove their superiority in your transmitter.

Send for your copy of the 1947 National catalog, containing a complete list of variable condensers and some 600 other parts, today.

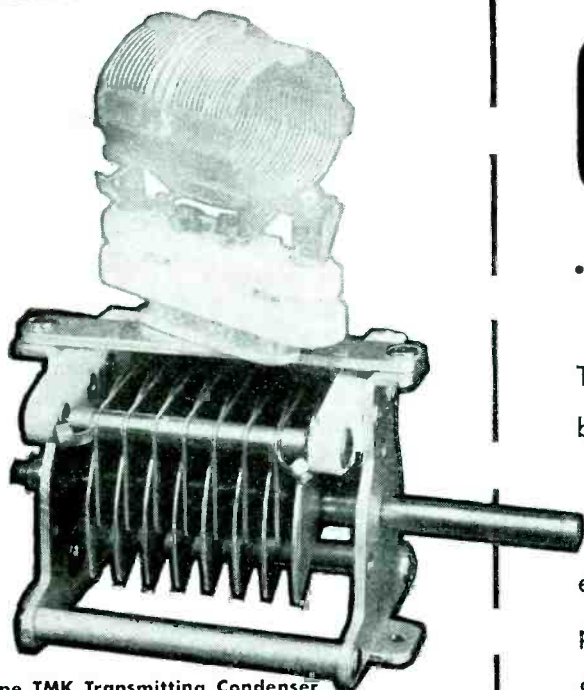

Type TMK Transmitting Condenser

An ideal condenser for exciters and low power transmitters. Available in single and double stator models. Steatite insulation. Special provision has been made for mounting AR-16 exciter coils in a swivel plug-in mount on either the top or rear of the condenser if desired. Over-all width 2-11/16", height 2-23/32".

Capacity (max.-min.)	Air Gap	Peak Voltage	Length	Catalog
35 mmf.-7.5	.047"	1500v.	2-7/32"	TMK-35
50 -8	.047"	1500v.	2 3/8"	TMK-50
100 -10	.047"	1500v.	3"	TMK-100
DOUBLE STATOR MODELS				
35/35 mmf.-7.5/7.5	.047	1500v.	3"	TMK-35D
100/100-10/10	.047	1500v.	4 1/4"	TMK-100D

Complete List in Catalog

**National
Company, Inc.**
Dept. No. 12
Malden, Mass.



Type TMC Transmitting Condenser

Designed for use in the power stages of transmitters where peak voltages do not exceed 3,000. The frame is extremely rigid. Insulation is steatite. The stator in the split stator models is supported at both ends. Over-all width 3-9/16", height 3-5/8".

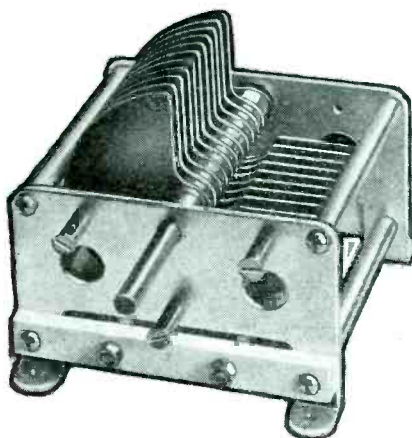

Capacity (max.-min.)	Air Gap	Peak Volt.	Len.	Cata.
50 mmf.-10	.077"	3000v.	3"	TMC-50
100 -13	.077"	3000v.	3 1/2"	TMC-100
250 -23	.077"	3000v.	6"	TMC-250
DOUBLE STATOR MODELS				
50/50 mmf.-9/9	.077"	3000v.	4 3/8"	TMC-50D
100/100-11/11	.077"	3000v.	6 3/4"	TMC-100D

Complete List in Catalog

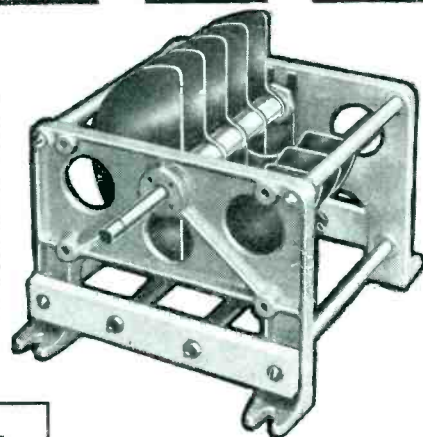

Type TML Transmitting Condenser

This is a 1 KW job throughout. Special steatite insulators prevent arc-covers. Sturdy cast aluminum end frames and dural tie bars permit an unusually rigid structure. Precision end bearings insure smooth turning and permanent alignment of the rotor. Over-all width 7", height 7-1/8".

Capacity (max.-min.)	Air Gap	Peak Volt.	Len.	Cata.
75 mmf.-25	.719"	20,000v.	18 1/8"	TML-75E
50 -22	.469"	15,000v.	8 1/2"	TML-50D
500 -55	.219"	7,500v.	18 1/8"	TML-500A
DOUBLE STATOR MODELS				
30/30 mmf.-12/12	.719"	20,000v.	18 1/8"	TML-30DE
60/60-	.469"	15,000v.	18 1/8"	TML-60DD
100/100-	.344"	10,000v.	18 1/8"	TML-100DB

Complete List in Catalog

MAKERS OF LIFETIME RADIO EQUIPMENT

AMPHENOL

RF CABLES AND CONNECTORS

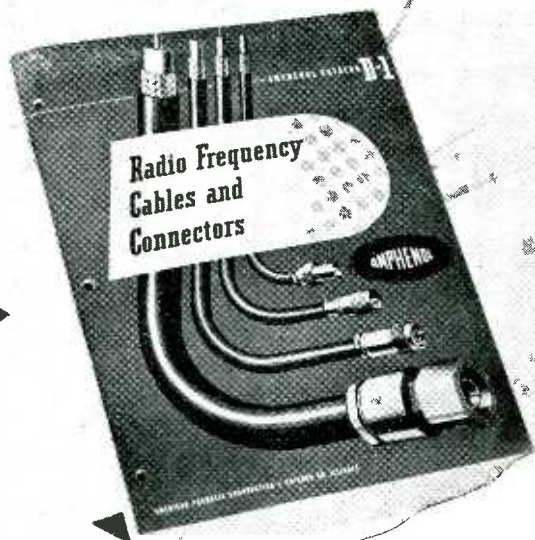

Efficient Connecting Links for Electrons at Work...

Amphenol radio frequency cables, connectors and cable assemblies assure lasting, low-loss continuity on highly critical circuits.

Available—from stock—to makers of electronic equipment and to amateurs, they are produced in several types. Each is designed to meet the requirements in a specific field of application.

To simplify your selection, the new Amphenol D-1 Catalog of radio frequency cables, connectors and cable assemblies includes decibel loss and power rating data of all cables. Functional illustrations and tabular matter quickly show which connector is needed for each cable. Installation dimensions are shown, as are instructions for the proper assembly of cables to connectors. Included is a cross-index of army-navy and Amphenol type designation numbers.

Write today on your business letterhead for your free copy of the new D-1 catalog. Amphenol will serve you well as a dependable source of supply. Catalog D-1 is today's guide for the engineer and purchasing agent in the selection of highest quality cables and connectors.

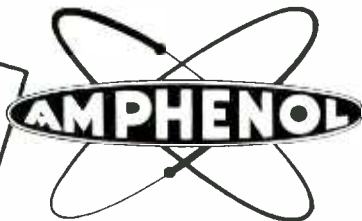

AMERICAN PHENOLIC CORPORATION

1830 South 54th Avenue, Chicago 50, Illinois

COAXIAL CABLES AND CONNECTORS • INDUSTRIAL CONNECTORS, FITTINGS AND CONDUIT • ANTENNAS • RADIO COMPONENTS • PLASTICS FOR ELECTRONICS



mercial or other application. Antenna leads and audio output are brought out at the rear of the chassis. The f-m antenna and feeder system also functions as the a-m antenna. The power supply is self-contained and operated from 115-volt 60-cycle source.

Image Camera (19)

INTERNATIONAL MUTOSCOPE CORP., Long Island City, N. Y. A television receiver, coin-operated, that is equipped with a camera for photographing images and delivering a finished print in one minute has been developed for use in amusement arcades.

VFO Exciter (20)

BARKER AND WILLIAMSON, INC., 237 Fairfield Ave., Upper Darby, Pa. The model 500 variable frequency oscillator provides high-stability



fundamental driving power on all amateur bands into a type 807 output tube that can be used as a transmitter or driver for higher power. The model 502 contains only the essential variable frequency oscillator elements.

Thyratron Modulator (21)

DORMITZER ELECTRIC & MFG. CO., 782 Commonwealth Ave., Boston 15, Mass. The model 12 laboratory type pulse modulator has been developed for high-frequency studies. It has a peak pulse power of 250 kw, maximum pulse duration of 6 mi-

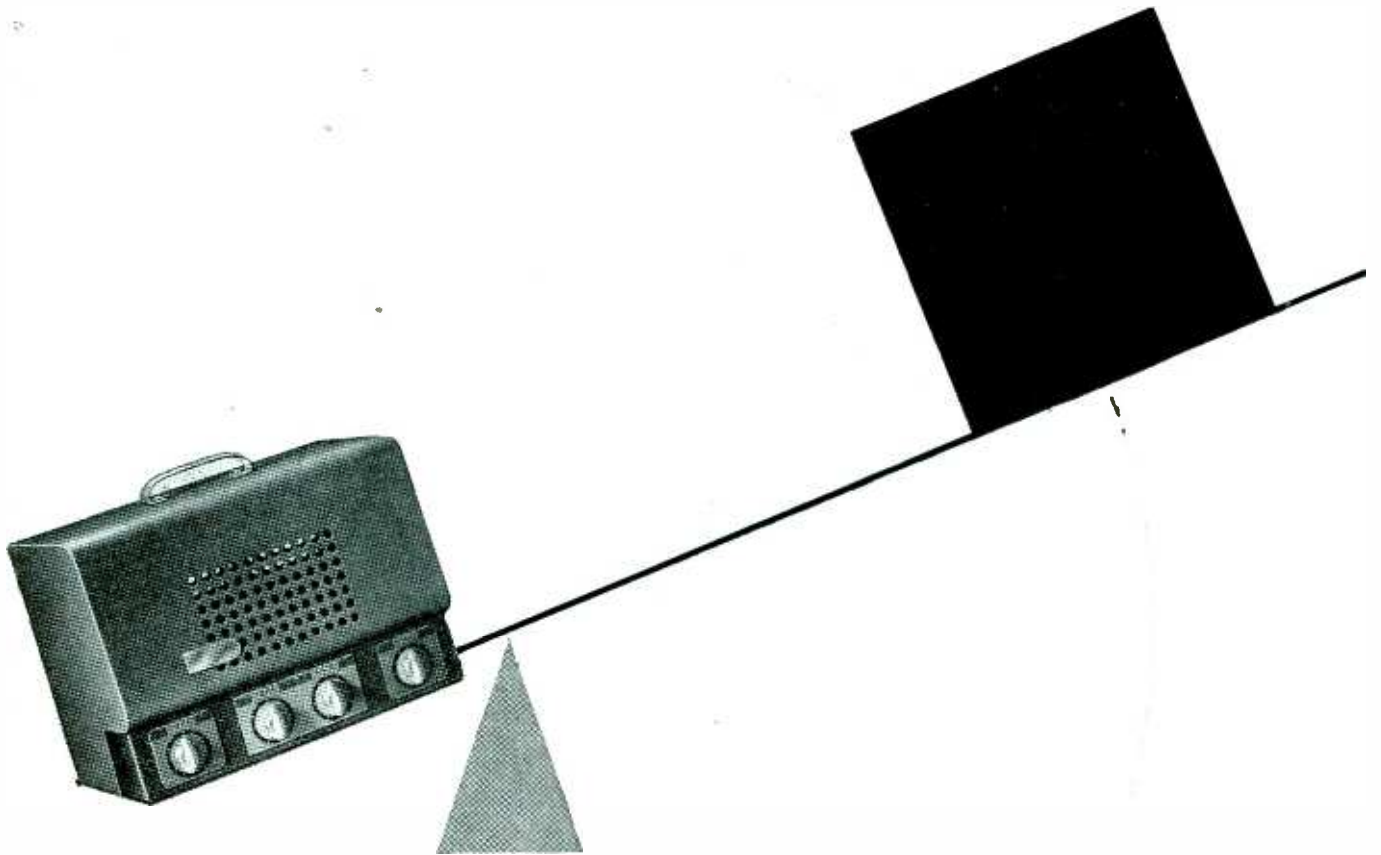

APPEARANCE HAS WEIGHT with most of us.

You can load the scales in your favor by utilizing the extra buy-appeal of Croname's new CQ cases.

CRONAME

INCORPORATED

3701 RAVENSWOOD AVE.
CHICAGO 13, ILLINOIS

You may send me literature on the new CQ cases.

My Name _____

Firm _____

Position _____

Address _____

City _____ Zone _____ State _____

Amateur **Please Check** Distributor Manufacturer
 Consulting Engineer Experimenter Service Dealer
 Custom Builder Industrial Designer _____

A
Quiet
Fellow
NOW GOING
PLACES



BECAUSE OF his build, character and performance, Astatic's Mr. "Q.T." Pickup Cartridge has earned the confidence of many leading radio-phonograph engineers and manufacturers, and is now "going places" as a vital unit in the newest, high quality-type record players.

If asked why the new Model "QT" Cartridge has been so generally approved, these designers and producers of phonograph equipment would undoubtedly state that the "QT" Cartridge supplies a clear, clean type of reproduction essentially free from annoying needle scratch, and that such reproduction remains constant during the life of the instrument.

This is true because the "QT" Cartridge is equipped with a MATCHED Needle, possessing all the qualities of a permanent needle yet having the advantage of being REPLACEABLE. This provides assurance that the original quality of reproduction shall be maintained throughout the life of the cartridge regardless of the number of times the needle is replaced. "QT"

Needles are available with precious metal or jewel tip, and may be easily inserted or removed when replacement is necessary. Special literature is available.

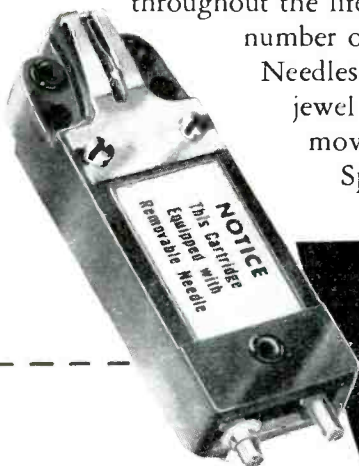

THE
Astatic
CORPORATION
CONNEAUT, OHIO
IN CANADA: CANADIAN ASTATIC LTD. TORONTO ONTARIO

Astatic Crystal Devices Manufactured under Brush Development Co. patents.

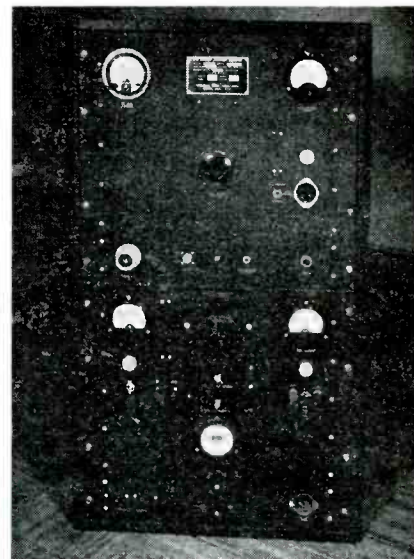

croseconds, minimum duration of 1 microsecond, maximum repetition rate of 4,000 pulses per second and operates into a 50-ohm load. A 200-volt positive trigger is required.

Freight Train Radio (22)

BENDIX RADIO, Towson, Md. The type MRT-2B vhf portable two-way railroad radio unit is designed primarily for use in end-to-end radio operation on freight trains. Overall

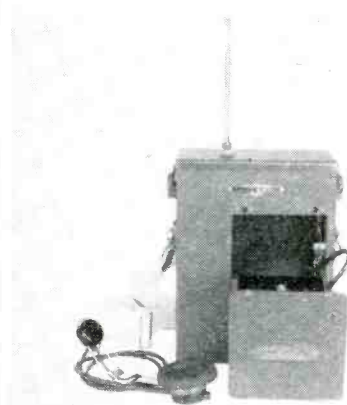

size of the equipment illustrated is 11 $\frac{1}{8}$ by 9 $\frac{1}{8}$ by 4 $\frac{1}{8}$ inches and the weight is only a little over 15 pounds. The equipment operates on railroad radio frequencies in the 160-mc region.

ECO Exciter for F-M (23)

COLUMBUS ELECTRONICS, Inc., 229 So. Waverly St., Yonkers, N. Y. The type FMO-428 eco exciter contains a reactance modulator for narrow-band f-m. Output for 80, 40, 20, and 10 meters can be modulated or

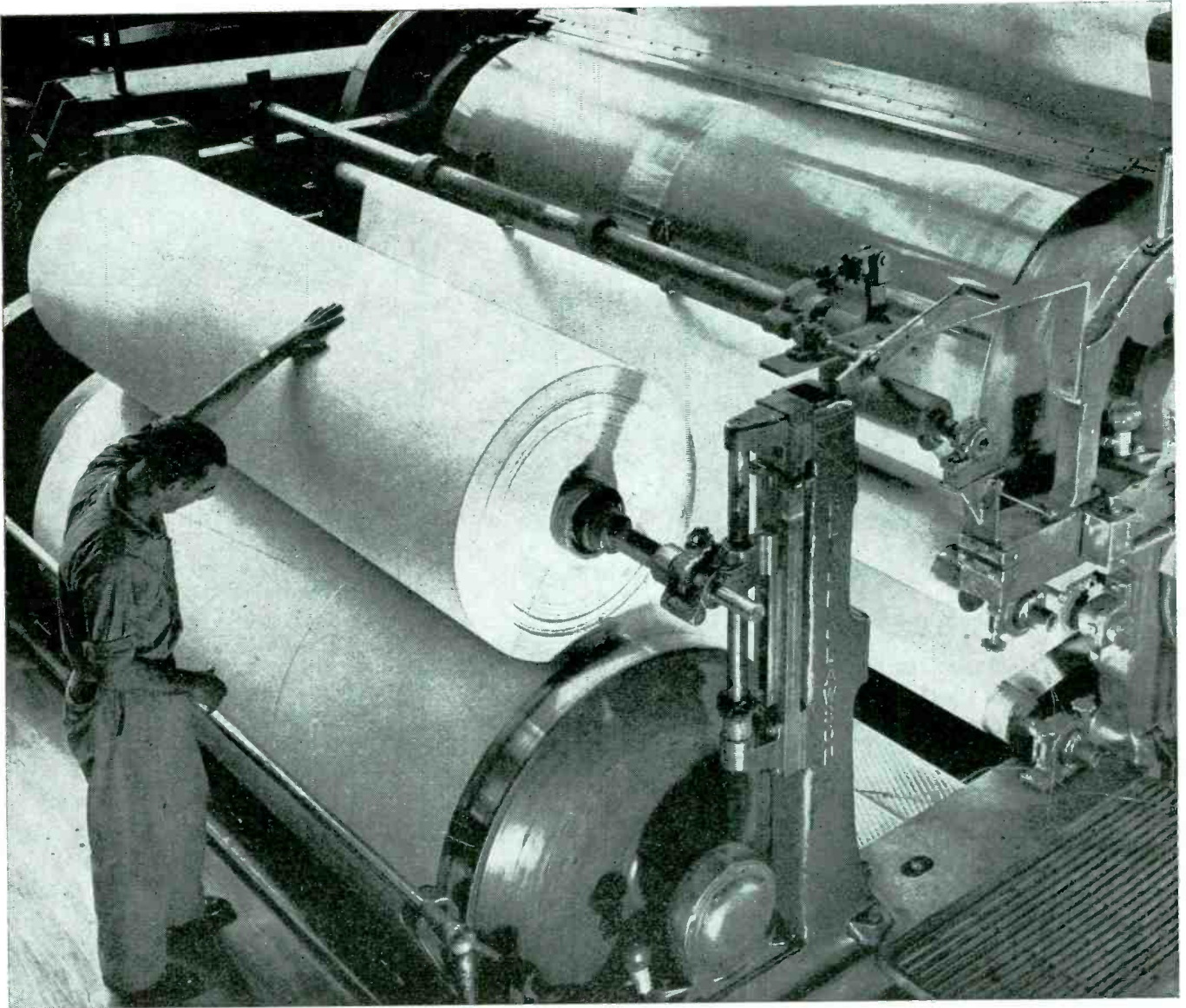

Our specialty is the manufacture of insulating papers for coils, transformers, condensers, or other insulating purposes...in thicknesses ranging from .0002" to .005".

SPECIALISTS IN THIN GAUGE INSULATING PAPERS

SCHWEITZER PAPER CO., INC.

New York Offices: Chrysler Building, New York 17, N. Y. Plants: Jersey City, N. J., Mount Holly Springs, Pa.

REPRESENTATIVES:

Chicago Area: Russ Dichtert Company, 612 North Michigan Avenue, Chicago 11, Illinois
West Coast: Electrical Specialty Company, 316 Eleventh Street, San Francisco 3, Calif.



**Bendix-
SCINTILLA**

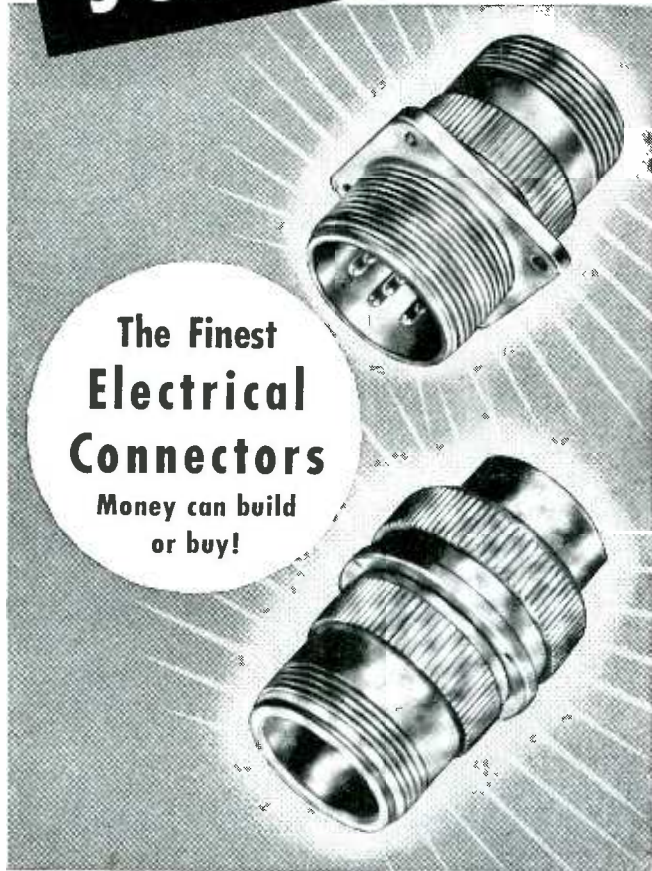

**The Finest
Electrical
Connectors**
Money can build
or buy!

AND THE SECRET IS SCINFLEX!

Bendix-Scintilla* Electrical Connectors are precision-built to render reliable peak efficiency—day-in and day-out even under difficult operating conditions. The use of Scinflex—a new Bendix-Scintilla developed dielectric material—makes them vibration-proof, moisture-proof, pressure-tight, and materially increases flashover and creepage distances. Even under extremes of temperature—from -67° F. to +300° F.—their performance is remarkable. Dielectric strength is never less than 300 volts per mil.

The contacts, made of the finest materials, carry maximum currents with the lowest voltage drop known to the industry. Check the list of outstanding features below—then write for detailed information on these truly superior connectors. They belong on every job where there is no compromise with quality.

*TRADEMARK

- Vibration-proof
- Moisture-proof
- Radio Quiet
- Single-piece Inserts
- No Temporary Overloads
- Pressure-tight
- Minimum Weight
- High Arc Resistance
- Easy Assembly and Disassembly
- Low Electrical Resistance

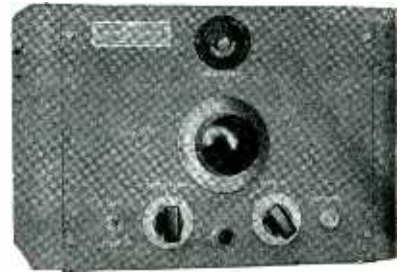

keyed as desired. Write for Bulletin E1.

Electrometer Triode (24)

RAYTHEON MFG. Co., Newton, Mass. The type CK570AX nonmicrophonic electrometer triode is now commercially available. Capable of measuring currents as low as 0.01 micromicroampere, the tube requires only 12.5 milliwatts of filament power. A data sheet including the recently declassified Zeus circuit is available from the Special Tube Section.

Automatic Tuner (25)

COLLINS RADIO Co., Cedar Rapids, Iowa. The type 496E Autotune unit is a precision tuning device for all radio and industrial applications

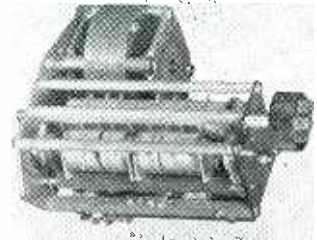

requiring an accuracy of one part in 36,000. Output torque is one inch-pound maximum and operating time is less than six seconds.

Marine Communicator (26)

WESTERN ELECTRIC Co., INC., 195 Broadway, New York 7, N. Y. Type 248A marine radiotelephone with dial code selector is distributed by the Graybar Electric Co. The remote control unit illustrated permits rapid operation of telephone service by providing instant selection or changeover from one to any other of the 30 optional operating frequencies between 2 and 20 mega-

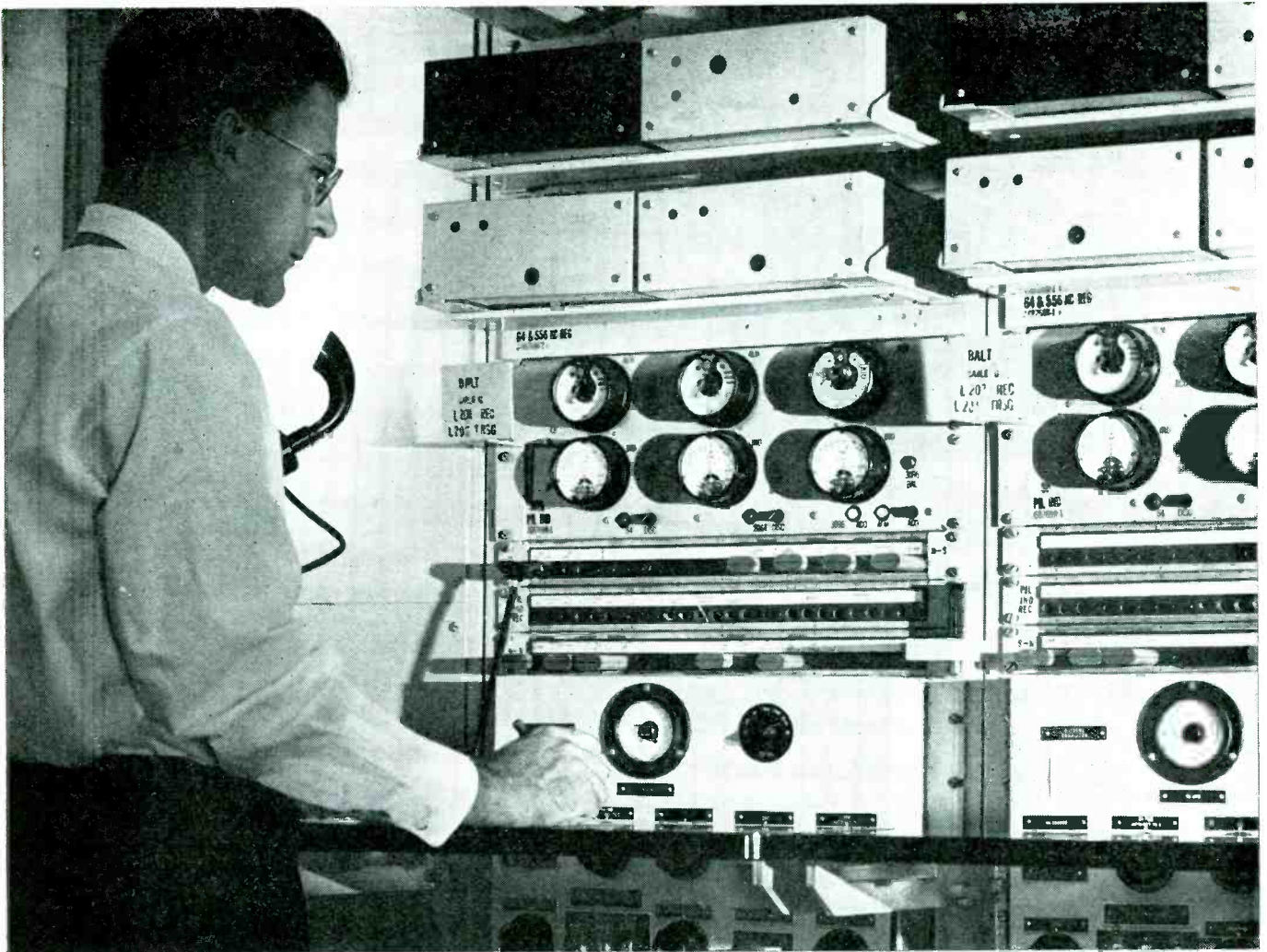

At Philadelphia, a testboard man answers as an electronic watchman calls attention to conditions on one of the coaxial systems to Baltimore and Washington.

“Send Help to Manhole 83”

Strung out along every Bell System coaxial cable, electronic watchmen constantly mount guard over your voice. Some are in manholes under city streets; some are in little huts on the desert. Most situations they can deal with; if things threaten to get out of hand, they signal the nearest testboard.

Principal care of the electronic watchman is the transmission level. Sunwarmed cables use up more energy than cold ones, so a transcontinental call may take a millionfold more energy to carry it by day than by night.

Each watchman — an electronic regulator — checks the transmission level and adjusts the amplification which sends your voice along to the next point. Many hundreds of regulators may be at work on a single long distance call.

Without automatic regulation, the precise control of energy in the Bell System's long distance circuits would be a superhuman task. So Bell Laboratories, which in 1913 developed the first high vacuum electronic amplifier, went on to devise the means to make them

self-regulating in telephone systems. This is one reason why your long distance call goes through clearly, summer or winter.

BELL TELEPHONE LABORATORIES

Exploring and inventing, devising and perfecting for continued improvements and economies in telephone service.





Present 3 clean-cut Advantages

1. **EXTREME UNIFORMITY**
2. **SUPERIOR STAKING QUALITIES**
... ends will roll without splitting.
3. **BETTER FOR MOLDED PARTS**
.. closed end keeps compound out.

If you use pins for vacuum tubes, adapters, fluorescent lamps, plugs, or electrical equipment of any kind, the chances are you'll save time, money and rejections by using these super-smooth, *seamless*, patented Radio Pins. They are available in a wide variety of styles and sizes, with staking end either closed or open. For a quotation, simply send a sketch, sample or description and state the quantity you need.

Radio or Radar Equipment?

In addition to Radio Pins, we produce large quantities of top caps, base shells and adapter shells for vacuum tubes; also a wide variety of other metal products including deep drawn shells and cups, blanks and stampings, ferrules, grommets, washers, vents, fasteners—and, for almost every manufacturing requirement, the world's largest assortment of eyelets. 17-1291



THE AMERICAN BRASS COMPANY Waterbury Brass Goods Branch

General Offices: Waterbury 88, Connecticut
Subsidiary of Anaconda Copper Mining Company
In Canada: ANACONDA AMERICAN BRASS LTD., New Toronto, Ont.



cycles. Three radio receivers facilitate traffic handling or simultaneous monitoring of three stations.

Retractable Cable (27)

SPECIAL PRODUCTS Co., Silver Spring, Md. Specords are rubber-covered conductors formed in spirals so that they will not kink or snarl in use. A single-conductor shielded microphone cable, for in-

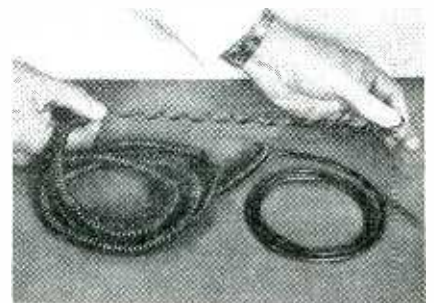

stance, has a retracted length of about 59 inches but stretches to 25 feet.

Thoriated Tungsten Tubes (28)

FEDERAL TELEPHONE AND RADIO CORP., Clifton, N. J. Thoriated tungsten filaments are used in tubes developed for use in 50-kw broad-

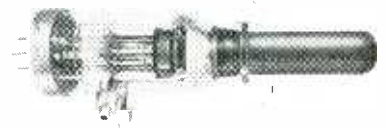

NEW!

Wilco Ni-Span C*

CONSTANT MODULUS ALLOY

NI-SPAN C is a Titanium-Chromium-Nickel-Iron alloy with the outstanding property of having a constant modulus, i. e. a zero thermoelastic coefficient, over a range of temperature from -50 to $+150^{\circ}\text{F}$. Most metals have a negative thermoelastic coefficient, that is they become elastically weaker or decrease in stiffness with rise in temperature. The important difference between Ni-Span C and other materials, whether of the constant modulus type or otherwise, lies in the fact that Ni-Span C is a precipitation hardening alloy in which the thermoelastic coefficient is adjustable through age hardening heat treatment. This unique combination of modulus control plus the high elastic and strength properties obtained through age hardening makes Ni-Span C a new material having very important commercial applications, the most important being those where constant elastic characteristics are required without the necessity of temperature compensating devices.

Advantages of NI-SPAN C:

1. Higher hardness and higher mechanical properties obtainable through a precipitation hardening heat treatment, than can be obtained with other constant modulus alloys through cold working.
2. An extremely important advantage of Ni-Span C is that the precipitation hardening heat treatment which brings about the marked improvement in physical properties can also be utilized to adjust the thermoelastic coefficient of a given Ni-Span C composition within a certain range by means of appropriate variation in this heat treatment.

Applications:

Watch and instrument hair springs, accurate weighing scale springs, and accurate springs of all kinds, where inherent temperature compensation is required. Diaphragms for pressure sensitive instruments. All types of parts in which extremely low creep or hysteresis values are required. While the controllable modulus property does not hold good beyond 150°F ., Ni-Span C has shown very small relaxation in long time tests up to 550°F .

NOW READY! Comprehensive Wilco Data Bulletin on NI-SPAN C, including complete physical and mechanical properties, recommended times for heat treatment and other pertinent information. Send for your copy.

Whatever your requirements for Wilco materials, our engineers will gladly help you meet them successfully.

WILCO PRODUCTS INCLUDE: THERMOSTATIC BIMETAL—Wide temperature ranges, deflection rates and electrical resistivities. **CONTACTS**—Silver-Platinum-Tungsten-Alloys-Sintered Powder Metal. **SILVER CLAD STEEL. JACKETED WIRE**—Silver on Steel, Copper, Invar or other combinations requested. **ROLLED GOLD PLATE AND WIRE** NI-SPAN C New Constant Modulus Alloy. **SPECIAL MATERIALS.**

*Reg. Trade Mark The International Nickel Co., Inc.

THE H. A. WILSON COMPANY

105 Chestnut Street, Newark 5, N. J. • Branch Offices: Chicago, Detroit, Los Angeles, Providence

SPECIALISTS FOR 30 YEARS IN THE MANUFACTURE OF THERMOMETALS • ELECTRICAL CONTACTS • PRECIOUS METAL BIMETALLIC PRODUCTS

WEBSTER ELECTRIC

meet demands for an
all-around good cartridge



Check your requirements

- Weight
- Response characteristics
- Voltage output
- Dimensions and mountings
- Type of terminals
- Type of ground
- Tracking pressures

• The wide selection of Webster Electric cartridges offers a cartridge with correct characteristics for your use. Correct weight, response, voltage output and other requirements so necessary for top performance.

Webster Electric cartridges are GOOD cartridges of balanced construction that produce maximum output at designated tracking pressures with minimum distortion and minimum mechanical reproduction. All models offer exceptionally uniform response over the desired range of frequencies, with low distortion and minimum needle noise.

Complete tone arm assemblies of improved design, in a wide selection of models, are also available to incorporate in your models.

All Webster Electric products are carefully designed and manufactured under highest quality standards. They have been on the market for years, and during this time have proved their value for long life and top performance.

(Licensed under patents of the Brush Development Company)

WEBSTER ELECTRIC

RACINE



WISCONSIN

Established 1909

Export Dept. 13 E. 40th Street, New York (16), N. Y. Cable Address "ARLAB" New York City

"Where Quality is a Responsibility and Fair Dealing an Obligation"

NEW PRODUCTS

(continued)

cast transmitters. The type 9C30 illustrated is designed for r-f amplifier service at frequencies up to 20 megacycles. Filament voltage is 15 volts and current is 135 amperes. Maximum plate voltage is 15,000 volts, and current 8 amperes. Plate input is 120 kw and 40-kw plate dissipation is allowable.

Microwave Diathermy (29)

RAYTHEON MFG. Co., Waltham, Mass. The Microtherm is a microwave diathermy equipment operating at 2.45 kilomegacycles and is intended to produce a rapidly penetrating heat in the human body. Because of its greater effect, less

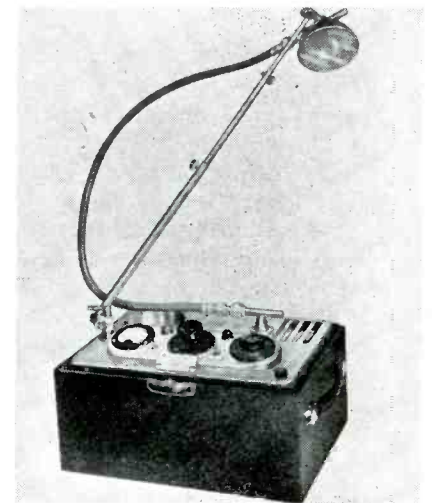

power is required for this than for conventional equipment and the unit is therefore portable.

Vacuum Gage Tubes (30)

RADIO CORP. OF AMERICA, Camden, N. J. Type 1945 ionization gage tube is used in a new vacuum leak

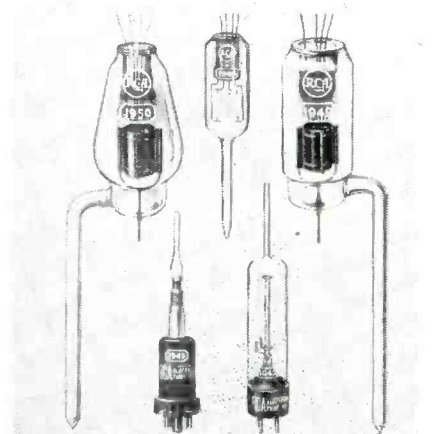

New Bulletin 547

Features VOLTAGE CONTROL by SUPERIOR ELECTRIC

All the information required for selection
of the correct voltage control apparatus
is included—
FOR EXAMPLE . . .

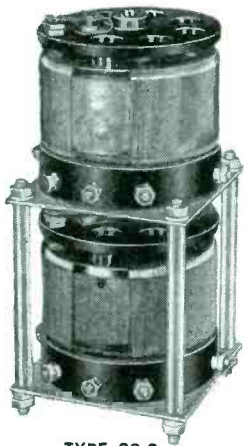
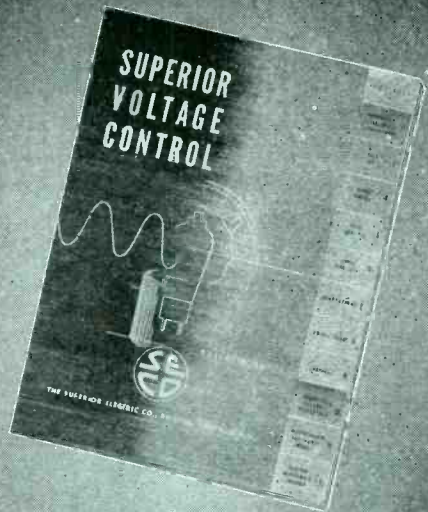

TYPE 20-2

POWERSTAT TYPE 20

Although the smallest in physical and electrical size of all POWERSTAT variable transformers, type 20 possesses all the essentials of superior voltage control equipment. It has excellent regulation . . . high efficiency . . . smooth control . . . and unusually rugged mechanical construction. Its current rating of 3.0 amperes exceeds all other units of comparable mounting dimensions. For three phase operation, type 20 can be ganged for wye or open-delta operation.



TYPE 20

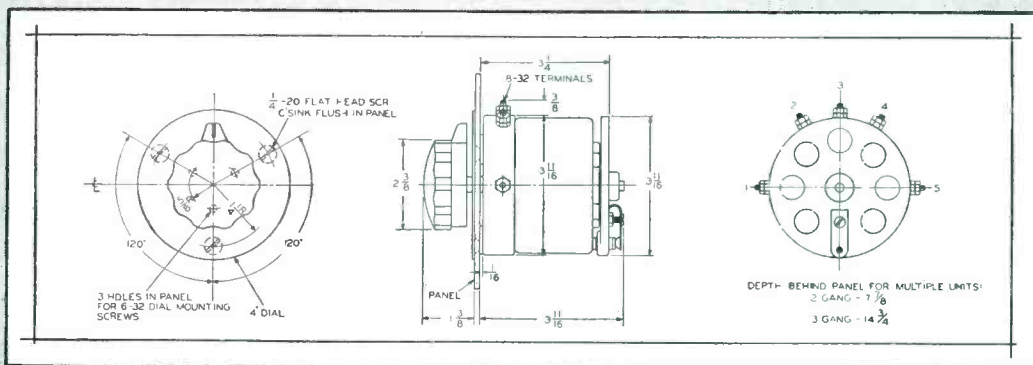

To get your copy of Bulletin 547 . . . for more information on
POWERSTAT type 20 and other voltage control equipment write

SUPERIOR ELECTRIC, 1091 Laurel Street, BRISTOL, CONNECTICUT.

THE SUPERIOR ELECTRIC CO.
BRISTOL, CONNECTICUT



POWERSTAT VARIABLE TRANSFORMERS • VOLTBOX A-C POWER SUPPLY • STABLINE VOLTAGE REGULATORS

How to bring those distant suppliers closer to home

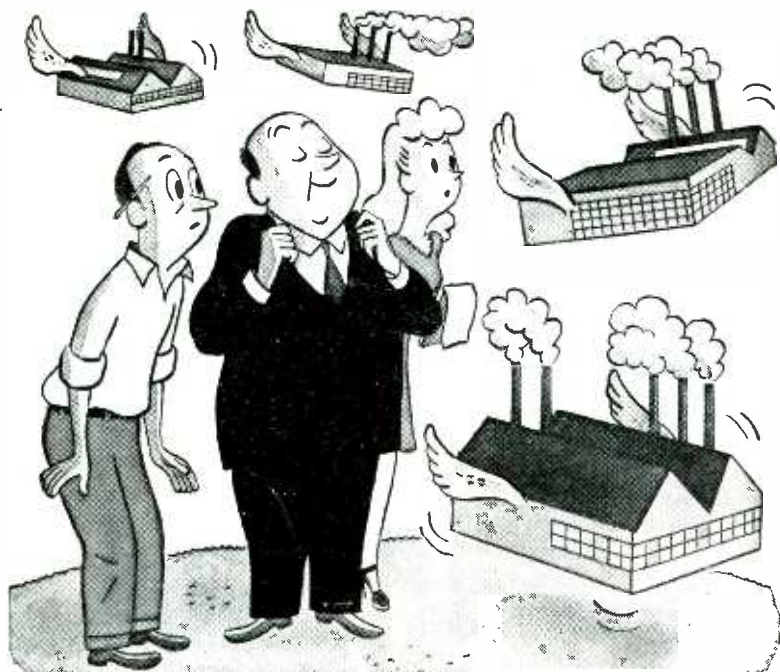

It's like having all your suppliers close at hand, when you specify Air Express delivery. Air Express gets you what's wanted in mere hours . . . no matter *where* your suppliers are located.

Planes carrying your Air Express shipments are bigger and faster today. Even overnight coast-to-coast deliveries are routine. Same day delivery between many airport towns and cities. And Air Express rates are *low*. Use this speedy, profitable service regularly to keep customers satisfied, and business running without a hitch.

Specify Air Express—it's Good Business

- Low rates—special pick-up and delivery in principal U.S. towns and cities at no extra cost.
- Moves on all flights of all Scheduled Airlines.
- Air-rail between 22,000 off-airline offices.
- Direct air service to and from scores of foreign countries.

Just phone your local Air Express Division, Railway Express Agency, for fast shipping action . . . Write today for Schedule of Domestic and International Rates. Address Air Express, 230 Park Ave., New York 17. Or ask for it at any Airline or Railway Express Office. Air Express Division, Railway Express Agency, representing the Airlines of the U.S.



Fastest delivery — at low rates

Trailer parts (51 lbs.) needed in Los Angeles *fast*. Picked up at Portland, Ore., factory 5 PM on 13th, delivered first thing next AM 821 miles away—in *time*! Air Express charge \$12.52! Other weights, any distance equally inexpensive and *fast*!

1927 — 20TH YEAR OF GETTING THERE FIRST! — 1947

detector. Sensitive only to hydrogen, the tube is connected into a vacuum system and a jet of hydrogen is then played over the areas to be checked for leaks. A small amount of the gas increases ion current in the tube to give an indication. Other ionization-type tubes are the type 1949 and type 1950. The 1946 is a thermocouple and the type 1947 is a Pirani gage.

Film Counter (31)

ARLINGTON ELECTRICAL PRODUCTS, INC., 18 West 25th St., New York 10, N. Y. A counter for use in motion picture viewing, dubbing and other operations can be remotely

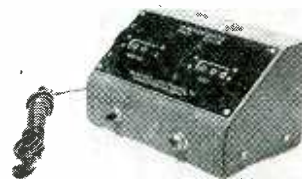

located from projector, recorder or dubbing head and will read elapsed time to 0.1 minute. The unit illustrated can be furnished for 35 or 16-mm film.

VTVM (32)

ELECTRONIC MANUFACTURING Co., 140 South Second St., Harrisburg, Pa., Model 110 vacuum tube volt-ohmmeter is useful for servicing television, transmitters, f-m, regular receivers and industrial appliances. The unit reads to 15,000 volts d-c, and 300 volts, a-c up to



electronics READER SERVICE . . .

LITERATURE and NEW PRODUCTS

Manufacturers' Literature as well as further information on New Products described in this issue are important "working tools" for design and production departments. To make it easy to keep up to date, ELECTRONICS will request manufacturers to send readers the literature in which they are interested. Just fill out card as shown in the filled-in sample (right), being particularly careful to write out in full all the information called for in each section of each card that is used.

<p>Write in circle number of item describing one item wanted → (4)</p> <p>Your Company Name <i>Jones Mfg Co</i> Address <i>3217 Lewis Ave</i> <i>Chicago 13, Ill</i> Your Name <i>Geo. Smith</i> Your Title <i>Chief Engineer</i> ELECTRONICS, 330 W. 42nd St., N. Y. 18</p>	<p>Write in circle number of item describing one item wanted → (32)</p> <p>Your Company Name <i>Jones Mfg Co</i> Address <i>3217 Lewis Ave</i> <i>Chicago 13, Ill</i> Your Name <i>Geo. Smith</i> Your Title <i>Chief Engineer</i> ELECTRONICS, 330 W. 42nd St., N. Y. 18</p>
<p>Write in circle number of item describing one item wanted → (37)</p> <p>Your Company Name <i>Jones Mfg Co</i> Address <i>3217 Lewis Ave</i> <i>Chicago 13, Ill</i> Your Name <i>Geo. Smith</i> Your Title <i>Chief Engineer</i> ELECTRONICS, 330 W. 42nd St., N. Y. 18</p>	<p>Write in circle number of item describing one item wanted → (49)</p> <p>Your Company Name <i>Jones Mfg Co</i> Address <i>3217 Lewis Ave</i> <i>Chicago 13, Ill</i> Your Name <i>H. S. Tawac</i> Your Title <i>Asst Mgr</i> ELECTRONICS, 330 W. 42nd St., N. Y. 18</p>

**SAMPLE
CARD
SHOWING
CORRECT
FILL-IN**



PLACE 1¢ STAMP ON CARD • DO NOT USE AFTER DECEMBER 1

HOW TO ORDER:

1. There are two postcards, each divided into four parts. Each of the four parts contains a box. You must write in this box the number that appears in this issue over the literature or new product item in which you are interested. Place one number only in each box.
2. Fill out completely (name, address, etc.) for each piece of literature or new product information you desire.
Do not say "same" in lieu of writing out full information called for when requesting more than one item.
3. This service applies only to literature and new product items in this issue. It does not apply to advertisements. Write directly to the company for information on its advertisements.

PLEASE NOTE: Requests for unnumbered items must be made direct to the manufacturer.

In the event this copy of ELECTRONICS is passed along to other members of your company, please leave this sheet in for their convenience. This assures everyone in your plant the opportunity to fill in their requests. When the round is completed, cards can then be detached along perforated lines and dropped in the mail. Each individual request will be mailed by us to the company offering the information and for that reason must be completely filled out.

Write in circle number of item describing one item wanted →

Your Company Name.....
Address.....
Your Name.....
Your Title.....
ELECTRONICS, 330 W. 42nd St., New York 18, N. Y.

Write in circle number of item describing one item wanted →

Your Company Name.....
Address.....
Your Name.....
Your Title.....
ELECTRONICS, 330 W. 42nd St., New York 18, N. Y.

Write in circle number of item describing one item wanted →

Your Company Name.....
Address.....
Your Name.....
Your Title.....
ELECTRONICS, 330 W. 42nd St., New York 18, N. Y.

Write in circle number of item describing one item wanted →

Your Company Name.....
Address.....
Your Name.....
Your Title.....
ELECTRONICS, 330 W. 42nd St., New York 18, N. Y.

Write in circle number of item describing one item wanted →

Your Company Name.....
Address.....
Your Name.....
Your Title.....
ELECTRONICS, 330 W. 42nd St., New York 18, N. Y.

Write in circle number of item describing one item wanted →

Your Company Name.....
Address.....
Your Name.....
Your Title.....
ELECTRONICS, 330 W. 42nd St., New York 18, N. Y.

Write in circle number of item describing one item wanted →

Your Company Name.....
Address.....
Your Name.....
Your Title.....
ELECTRONICS, 330 W. 42nd St., New York 18, N. Y.

Write in circle number of item describing one item wanted →

Your Company Name.....
Address.....
Your Name.....
Your Title.....
ELECTRONICS, 330 W. 42nd St., New York 18, N. Y.

An electronics service designed for READERS and MANUFACTURERS

FOR THE READER . . . ELECTRONICS fundamental policy has always been to supply its readers with all the pertinent and timely industry news. The ELECTRONICS Reader Service supplements this policy by offering the reader an easy and effective means of obtaining complete, up to the minute data on new products and of maintaining at his fingertips comprehensive, practicable information on "who's doing what" in the industry.

In every issue of ELECTRONICS there's complete coverage of the month by month development by manufacturers of new materials, components and equipment, as well as brief mention of all the important, new, manufacturers' technical pamphlets and catalogs. Some of these items will be of particular interest to specific design and plant engineers, buyers, executives and others of our readers. They will want to make further inquiry concerning the new products described or they will want to read and make a permanent part of their industrial library some of the manufacturers' literature and catalogs.

ELECTRONICS Reader Service makes it easy for them to obtain in readily accessible and usable form the information they desire.

PLACE 1¢ STAMP ON CARD • DO NOT USE AFTER DECEMBER 1

Place
1¢
Stamp
Here

ELECTRONICS

330 WEST 42nd STREET

NEW YORK 18, N. Y.

9-1-47

Place
1¢
Stamp
Here

ELECTRONICS

330 WEST 42nd STREET

NEW YORK 18, N. Y.

9-1-47

FOR THE MANUFACTURER . . .

ELECTRONICS Reader Service will also be welcomed by manufacturers who are desirous of placing the complete news of their product developments as well as their technical bulletins and catalogs in the hands of those members of the electronic industry . . . including design, electrical and production engineers, researchers, physicists, executives, and buyers—who have a particular interest in, or represent a potential buying power for, their products.

SUGGESTIONS FOR THE IMPROVEMENT OF OUR READERS' SERVICE ARE INVITED

ELECTRONICS is constantly seeking new and improved ways of providing its readers with the news and information they want and need, and of assisting the manufacturer in effectively delivering his message to electronic markets. If you have any ideas for us, send them along. They will receive prompt consideration.

USE G-E MYCALEX INSULATION

FOR HIGH HEAT RESISTANCE

Plus these 5
Insulation Advantages...

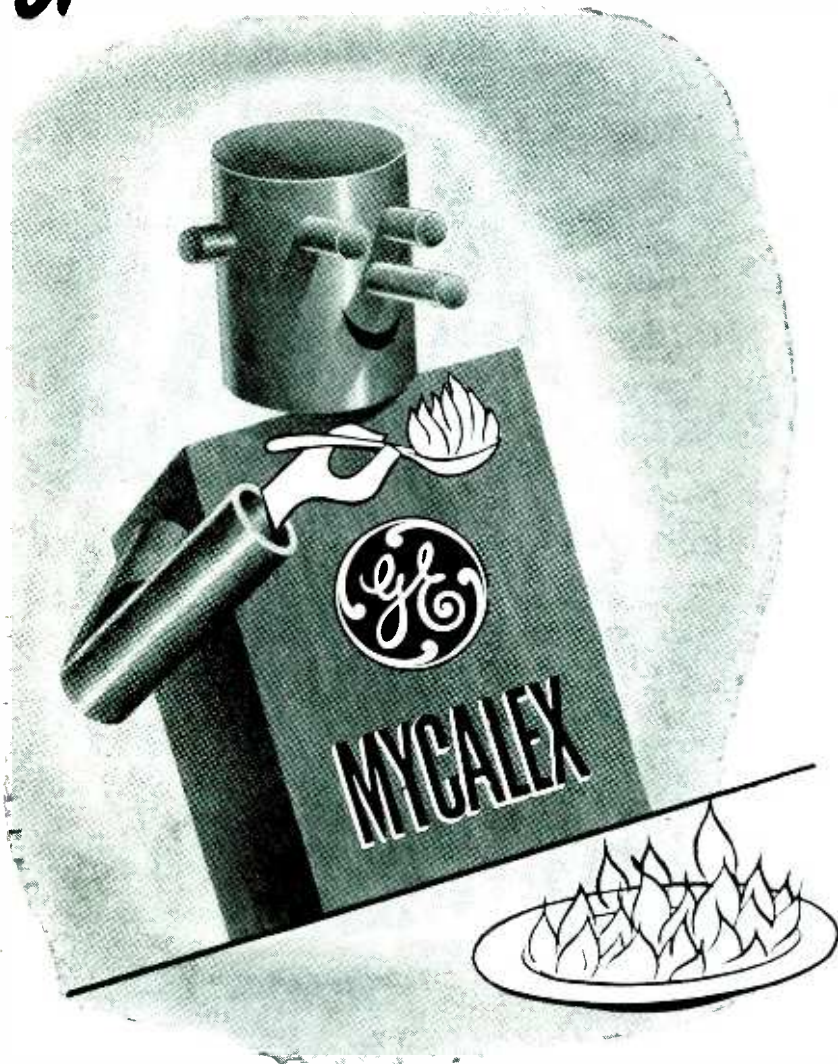

• HIGH DIELECTRIC STRENGTH

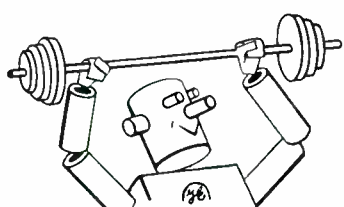

• HIGH MECHANICAL STRENGTH

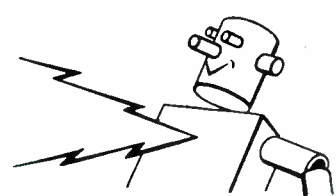

• HIGH ARC RESISTANCE

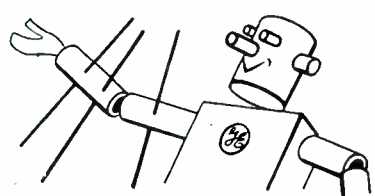

• FIRM BOND TO METAL INSERTS

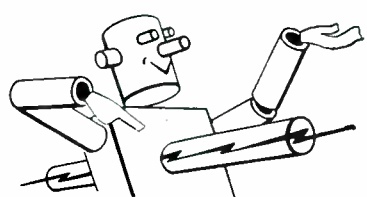

• LOW LOSS FACTOR

• General Electric mycalex is an exceptional insulation material because of its unique combination of properties. Use G-E mycalex when insulator designs call for a firm bond to metal inserts *plus* excellent resistance to heat and arcing, high dielectric and mechanical strength, and a low loss factor. G-E mycalex is a gray, stone-hard compound of glass and mica that can be ordered in standard rods and sheets. Or it can be molded or fabricated to your specifications.

General Electric has complete molding and fabricating facilities for producing G-E mycalex parts in any quantity. Let General Electric's mycalex specialists fabricate sample parts for you to test. After testing, your designs can be converted to the speediest, most economical molding processes. To get the complete story, send for the booklet, "G-E MYCALEX". Write to Section S-21, Plastics Division, Chemical Department, General Electric Company, 1 Plastics Avenue, Pittsfield, Mass.

GENERAL  ELECTRIC

CD47-M21



Now study
Transient Phenomena
with
Magnetic Recording!

Brush Transient Recorder

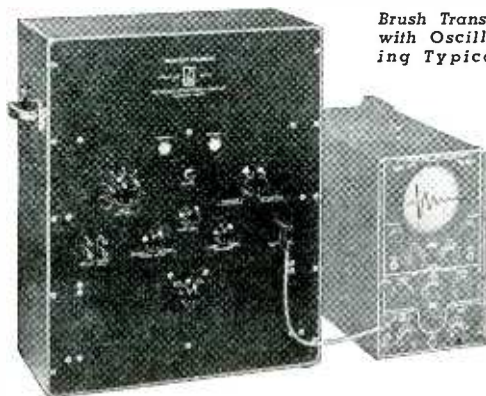

Brush Transient Recorder
with Oscilloscope Showing
Typical Transient

automatically records transient phenomena of less than 2/10 second duration—either electrical or capable of being picked up by electrical gauges.

Some typical phenomena which may be recorded by the Brush Transient Recorder include spot welding currents, light flashes, arc discharges, impact loads, etc. These results are accomplished by magnetically recording on a rapidly moving steel tape a frequency modulated carrier. Reset button clears tape and prepares it for re-use.

Brush representatives will be glad to discuss applications of this instrument in solving your particular laboratory or production problems. For complete details write today for further information.

The Brush Development Co.

3415 Perkins Avenue • Cleveland 14, Ohio

Canadian Representatives: A. C. Wickman, (Canada) Ltd.
P. O. Box 9, Station N, Toronto 14, Canada

300 megacycles. Critical resistors have a heat loop and are fungus-proofed.

Audio Peak Limiter (33)

THE LANGEVIN CO., INC., 37 West 65th St., New York 23, N. Y. Type 119-A Progar unit is a fast acting peak limiter preceded by an automatic gain control amplifier with variable time constants. In broad-



cast station applications the circuits can be employed to insure a higher average percentage of modulation than can be obtained with a limiter alone. A catalog sheet is available describing the equipment and its use.

Indicator Lights (34)

AMERICAN ELECTRONICS CORP., 226 No. Fourth St., Columbus, Ohio, announces a line of standard neon-

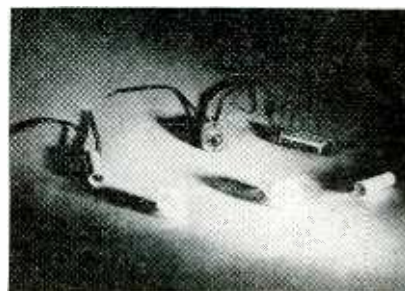

glow lamp indicators. The units are composed of a high heat-resisting outer housing provided with suitable mounting bracket that encases a neon-glow lamp and proper resistance for operating on voltages of 70 volts and upward, a-c or d-c.

Oil Vapor Vacuum Pump (35)

LITTON ENGINEERING LABS., San Carlos, Calif. Model 250 series oil

For SIMPLE CONVERSION to A-C OPERATION

SEVERAL G-R instruments, equipped with a battery block to secure the maximum portability for field use, are often operated continuously for many hours in the laboratory, in testing and in production. For such uses an a-c operated power supply to replace the battery is a great convenience.

The Type 1261-A Power Supply was designed for this use. Mechanically and electrically it is interchangeable with a BA48 battery, supplying the same voltages and current. It is interchangeable with the BA48 battery in the Type 759-A or -B Sound Level Meter, the Type 720-A Heterodyne Frequency Meter and the Type 1231-A Amplifier & Null Detector.

It also can be used as a general-purpose substitute for a BA48 battery. Its output is: FILAMENT SUPPLY: 1.5 or 3.0 volts up to 350 ma; PLATE SUPPLY, when used on a 115-volt 60-cycle-line with normal filament current of 300 ma: 133 volts, open circuit; 107 volts at 3 ma; 89 volts at 5 ma; 72 volts at 7 ma; maximum output current of 8 ma.

A selenium rectifier and L-C filter with two flashlight cells floating across the output provide a low-impedance, well-filtered and regulated d-c filament supply. A relay opens the circuit when the instrument is not in use so that the life of the batteries is equivalent to their shelf life.

A conventional vacuum-tube rectifier and R-C filter provide the plate supply. A 4-terminal output socket fits the plug on the battery cable of the instruments which use the BA48 battery; octal selector plugs inserted into a socket on the power supply make it possible to select filament and plate voltages for various needs.

IMPORTANT — When ordering be sure to specify type and serial number of any of the three G-R instruments with which the supply is to be used; otherwise we will ship a selector plug which the user can wire to meet his individual requirements.

TYPE 1261-A POWER SUPPLY \$95.00

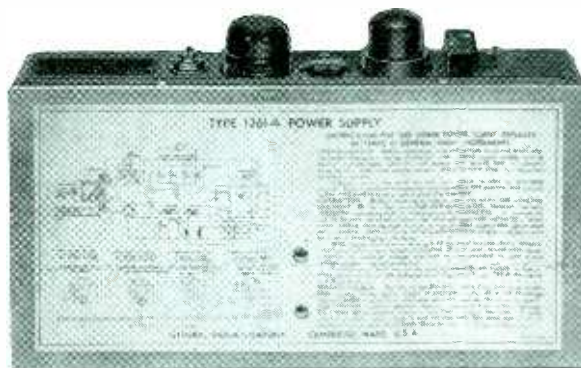

TYPE 759-B SOUND-LEVEL METER

For all types of Noise Measurements, Accurate, very sensitive, anyone can operate.



TYPE 1231-A AMPLIFIER & NULL DETECTOR

A high gain general-purpose laboratory amplifier and a sensitive visual null detector for bridge measurements.

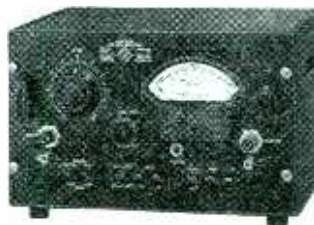

TYPE 720-A HETERODYNE FREQUENCY METER

For measurement of frequencies by harmonic methods between 10 and 3,000 megacycles.

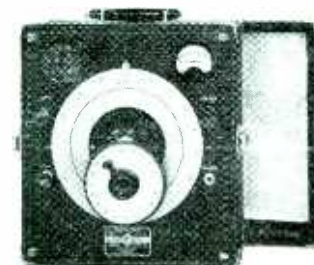

A-C SUPPLY TO REPLACE STORAGE BATTERIES

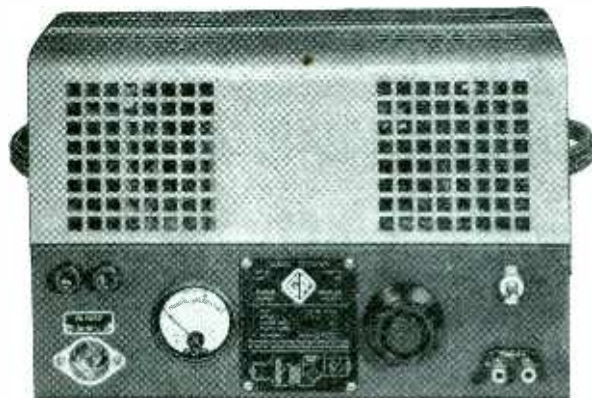

● The Type 1260-A VARIAC*-RECTIFIER effectively replaces the usual storage battery for general laboratory use. It is a convenient variable d-c voltage source for use in many types of experimental circuits for operation from 115-volt, 60-cycle lines.

Essentially this supply consists of a transformer with VARIAC*-controlled input, a selenium rectifier, an output filter and a d-c output meter.

The output voltage range is 0-10 volts at 4 amperes; maximum power of 40 watts; maximum current 4 amperes; no-load voltage 15. The power input at full 40-watt load is about 75 watts; the hum voltage at 10 volts, 4 amperes, is less than 100 millivolts or 1% of the output voltage, when the supply is operated on a 60-cycle line.

This supply is a very convenient unit for operating battery-driven equipment at voltages up to 10 volts. The ability to set the d-c voltage at any desired value between 0 and 10 is an added advantage in many cases.

TYPE 1260-A VARIAC*-RECTIFIER \$125.00

**Reg. U.S. Pat. Off.*

ORDER NOW — Delivery of BOTH Probably from STOCK



GENERAL RADIO COMPANY

Cambridge 39,
Massachusetts

90 West St., New York 6

920 S. Michigan Ave., Chicago 5

950 N. Highland Ave., Los Angeles 38

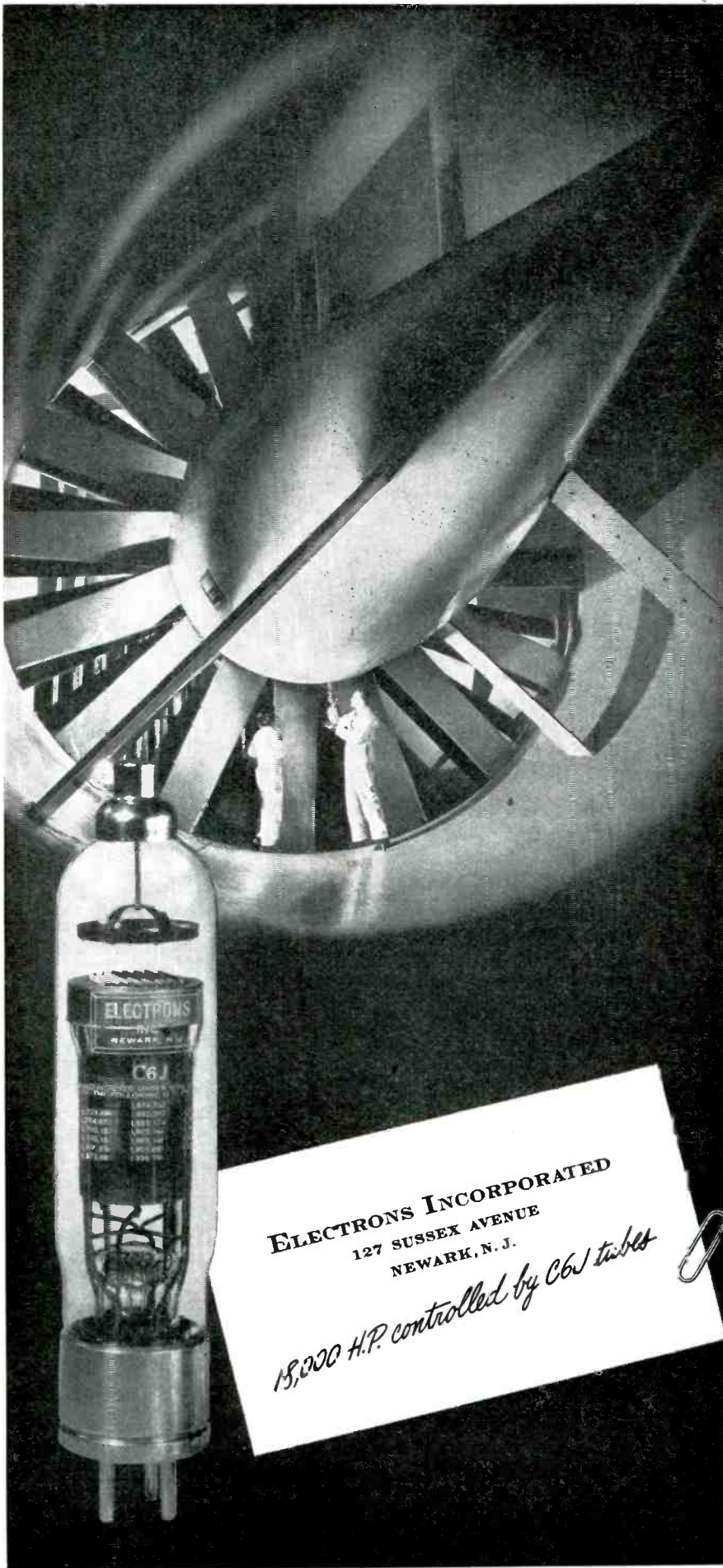

NEW PRODUCTS

(continued)

vapor vacuum pumps are constructed entirely of steel and are water cooled to insure proper action in hot places. Boiler and charcoal baffles are easily demountable for cleaning purposes. Complete characteristics, prices, and dimensions are available on request.

Recording Console (36)

REK-O-KUT Co., 146 Grand St., New York, N. Y. A new console for recording or transcription equipment

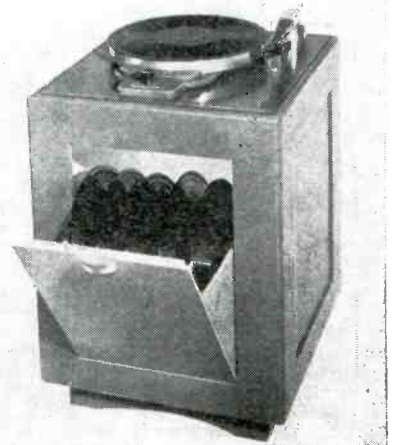

has a drop-front door and pockets for holding approximately 100 sixteen-inch recordings. Four screw jacks are provided for leveling the console.

Marine Radiophone (37)

JEFFERSON - TRAVIS, INC., 111 Eighth Ave., New York 11, N. Y. Model 351 marine radiotelephone for 12 or 32-volt operation comprises 5 crystal-controlled channels for transmitting and receiving covering the complete 2 to 3 mc marine band. The entire unit is housed in



What's your Fine Wire problem?

Problem 1

Mr. Plate had miles of wire but he needed it gold plated. Just a call to Fine Wire Headquarters and we agreed to add the protection plus the fine appearance of gold. If you have a plating problem, we have the plating facilities.



Problem 2

Mr. Fine had to have some .001 copper wire to fill an important order. So Fine Wire Headquarters transformed his coarse copper wire to .001. We can do the same for you if you have wire that's too big.

Problem 3

Mr. Insulate needed enamelled fine wire. So he ordered from Fine Wire Headquarters, and received fine enamelled copper wire made to his specifications.



the answer

WHY not call Fine Wire Headquarters when you have a question about fine wire? We can't do the impossible, but we can do lots of things that can bring you the right fine wire

for the job. So—when you have a Fine Wire problem—wire, phone or write to North American Philips, makers of NORELCO Fine Wires, and ELMET Tungsten and Molybdenum products.

NORTH AMERICAN PHILIPS COMPANY, INC.

Dept. E-9, 100 East 42nd St., New York 17, N. Y.

CORNISH

WIRES

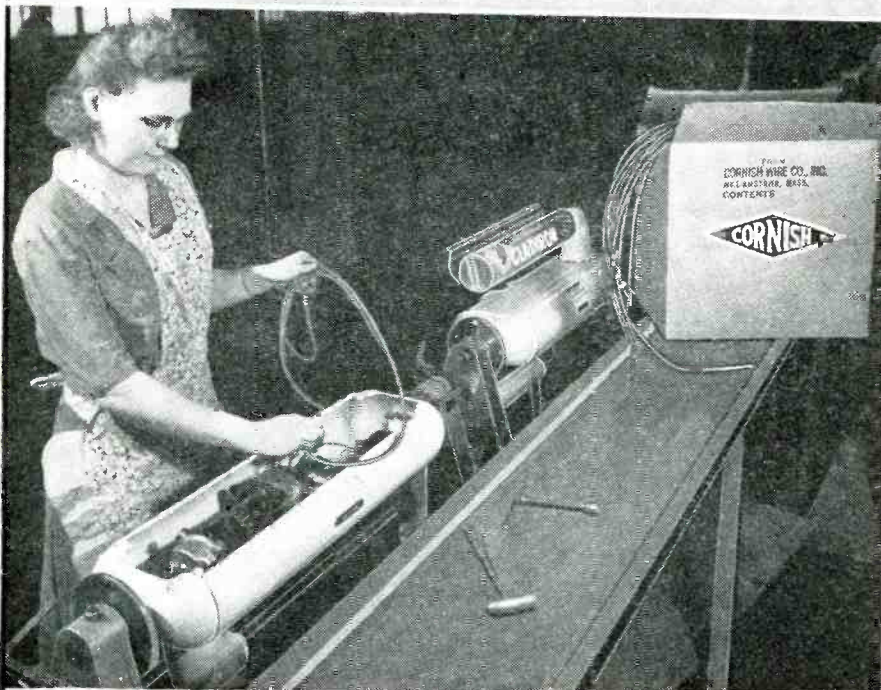

Courtesy HURLEY Machine Division, makers of GLADIRONS

WHY ARE **CORNISH** WIRE PRODUCTS SPECIFIED BY THIS LARGE MANUFACTURER OF IRONING MACHINES?

Because their **ENGINEERING** Department knows by test that they will give faithful and enduring performance . . .

Because their **PRODUCTION** Department finds that they have those qualities essential for quick installation on their assembly line . . .

Because their **PURCHASING** Department realizes that these Quality Products, backed by dependable service, are sold at prices that spell true economy . . .

CORNISH WIRE CO., INC.
 15 Park Row • New York City, 7

NEW PRODUCTS

(continued)

a steel cabinet 21 × 15½ × 10 inches.

Gas Observing Unit (38)

GOW-MAC INSTRUMENT Co., 22 Lawrence St., Newark 5, N. J. The new thermal conductivity unit provides an accurate and inexpensive means for observation, analysis and test-

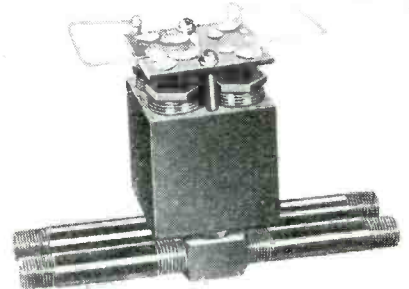

ing of gases. It incorporates four filaments assembled in appropriate chambers and wired in a balanced bridge arrangement. Compact in size, the unit is specially constructed for high sensitivity, long life and stability.

Improved Headset (39)

TELEX, INC., 1370 Northwestern Bank Bldg., Minneapolis 2, Minn. The Monoset has recently been improved by the addition of a volume



control. The lightweight underchin construction of the headset makes it easy to wear for long periods.

Volt-Ohm-Milliammeter (40)

PRECISION APPARATUS Co., INC., 92-27 Horace Harding Blvd., Elm-

PICK A NUMBER
ANY FREQUENCY FROM 10 TO 1,000

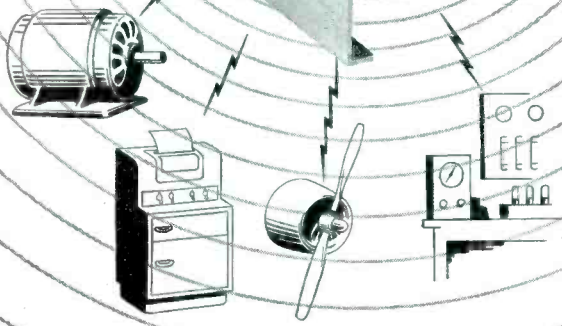
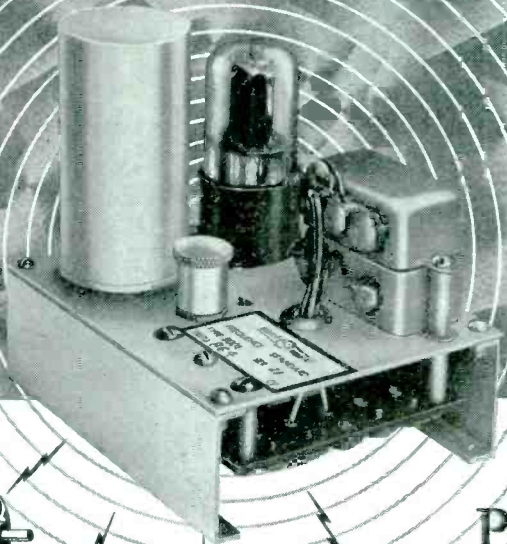

Pictured here is a tuning-fork frequency standard with accuracy guaranteed to one part per million per degree Centigrade. The fork is temperature-compensated and hermetically sealed against variations of barometric pressure. This standard, when combined with basic equipment, facilitates accurate speed and time control by mechanical, electrical, acoustical or optical means.

The unit is available separately or in conjunction with complete timing instruments. Our engineers are ready to cooperate on any problem.

MOTORS • FACSIMILE • AIRCRAFT • LABORATORIES

American Time Products, Inc.
580 Fifth Avenue
New York 19, N. Y.

OPERATING UNDER PATENTS OF THE WESTERN ELECTRIC COMPANY



OLD PRESSURE 35 GRAMS

NEW PRESSURE 22 GRAMS

PARA-FLUX REPRODUCER

gives less wear on record . . . lighter impact of stylus . . . and improves a well-known tone quality

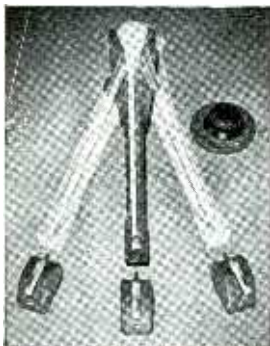

Para-Flux Reproducer with interchangeable Heads:
 Universal . . .
 Lateral only . . .
 Vertical only

R-MC engineering skill applied to reproducer design gives all the advantages that discriminating users demand: More realistic reproduction of transcriptions . . . a reproducer of precision-build, sturdy construction, with finest materials obtainable . . . embodying up-to-the-minute features, including convenient finger lift for preventing slipping of Reproducer when lifted off record. A highly polished aluminum alloy center-piece of tone arm and head enhances the attractive design of Reproducer.

This new lightweight Head, either Vertical only, Lateral only, or Universal, functions correctly with all R-MC Tone Arms now in service. Therefore it is not necessary to change arm in service when ordering the new Head.

Whenever you may need a new PARA-FLUX Head, your R-MC Jobber will supply you with the new lightweight head . . . immediately . . . in exchange for your old one, in accordance with our standard replacement policy and exchange price.

Available through authorized jobbers. Illustrated Bulletin R-6 on request.

RADIO-MUSIC CORPORATION
 EAST PORT CHESTER • CONN.

NEW PRODUCTS

(continued)



hurst, L. I., N. Y. The series 858 pushbutton meter has a resistance of 20,000 ohms per volt and ranges including 6,000 volts, 600 megohms, 12 amperes, 70 db and 60 microamperes. The model 858-P illustrated has a hardwood case with hinged cover for portable use. Laboratory users may prefer the model 858-L.

Carrier Systems (41)

F. W. LYNCH Co., San Francisco, Calif. Rack-mounted, multichannel carrier telephone equipment can be

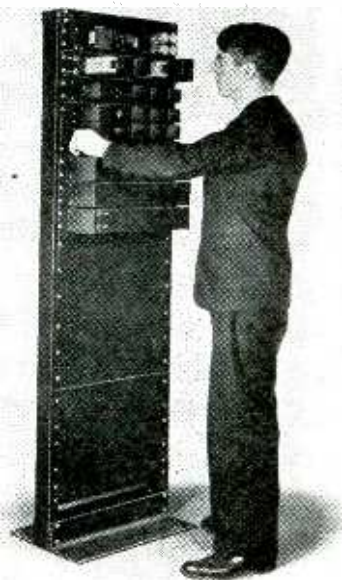

used to expand present wire telephone facilities of industrial and railroad users. With repeaters, operation of over 1,000 miles is feasible.

Dual Capacitor (42)

CORNELL-DUBILIER ELECTRIC CORP., South Plainfield, N. J. The type BRL-2215SS dual 20-microfarad capacitor is equipped with two leads for each unit making the component more versatile than the con-

GENERAL CONTROL BUILDS

The world's most versatile SWITCH

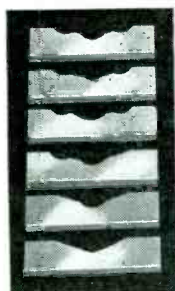

MODEL
MCM
WITH PATENTED*
DETENT INSERTS

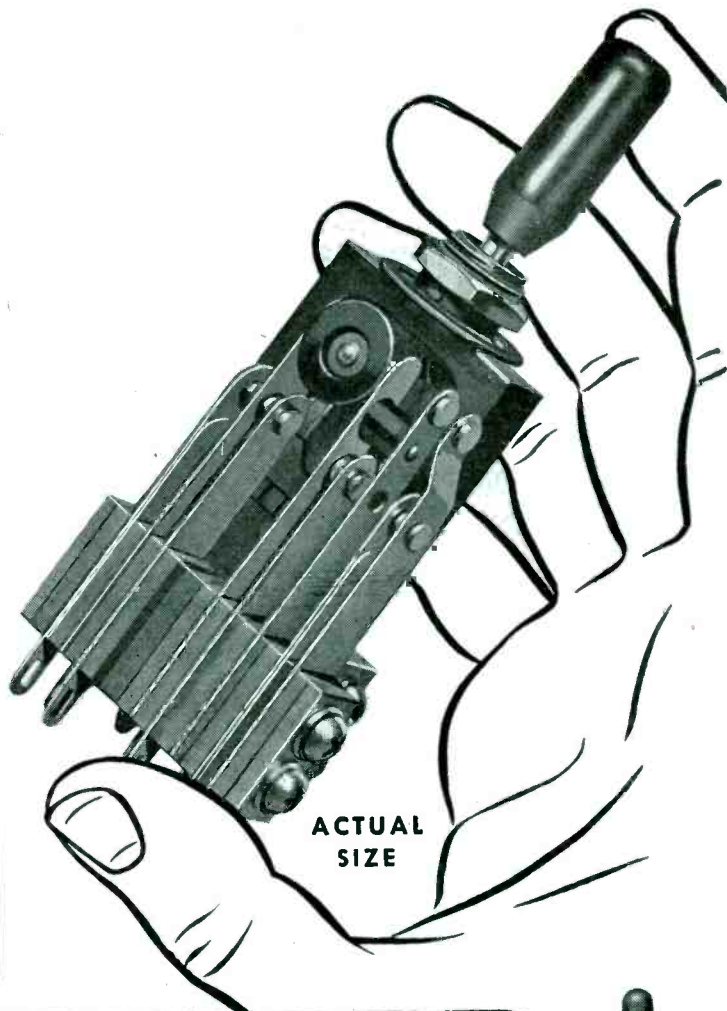
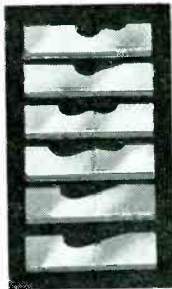

ACTUAL
SIZE

General Control Company announces a new feature for its Model MCM "Midget" lever switches—a feature which makes possible true custom-built switches from standard parts. By means of small, stainless steel inserts, shown above, the MCM "Midget" can be provided with a wide variety of detent actions to meet the most exacting requirements. Light or heavy action, two or three positions, locking or non-locking and special intermediate stops—all are possible with this versatile detent mechanism. The inserts are riveted in permanently at the factory. They preserve the original "feel" of the switch throughout its life—tests show negligible wear after 1,000,000 operations!

Write for details on the complete line of General Control lever switches, or, better yet, send us your switching requirements and take advantage of our engineering service.

*PATENT NO. 2,411,086

OTHER MCM FEATURES

- ★ Single hole mounting for easy panel fabrication.
- ★ Removable contact assembly for easy wiring.
- ★ Light weight— $3\frac{1}{2}$ oz. with 12 contact blades.
- ★ Small size—depth behind panel only $2\frac{3}{4}$ inches.
- ★ High capacity—5 amperes non-inductive at 115 volts AC.
- ★ High dielectric strength—tested at 2500 volts AC to ground.
- ★ Versatility: Can be supplied with angle mounting bracket when space behind panel is limited. Rotary actuator available. Waterproof handle assembly for marine or aircraft applications.



MCM
With Waterproof Handle
Assembly

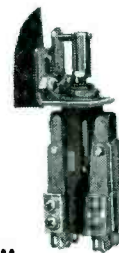

MCM
With Rotary Actuator

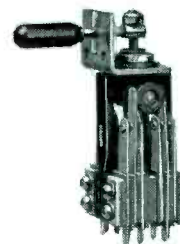

MCM
With Angle Mounting
Bracket



GENERAL CONTROL COMPANY

1202 SOLDIERS FIELD ROAD, BOSTON 34, MASSACHUSETTS

Designed for



Application



92101

The No. 92101—Antenna Matching Pre-amplifier

The Millen 92101 is an electronic impedance matching device and a broad-band pre-amplifier combined into a single unit, designed primarily for operation on 6 and 10 meters. Coils for 20 meter band also available. This unit is the result of combined engineering efforts on the part of General Electric Company and the James Millen Manufacturing Company. The original model was described in C.E. Ham News, November-December, 1946. The No. 92101 is extremely compact, the case measuring only 6 1/4" x 5 3/4" x 3". The band changing inductor unit plugs into the opening in the front of the panel. Plug is provided for securing power requirements for the 6AK5 tube from the receiver. Coaxial connectors are furnished for the antenna and receiver connections.

JAMES MILLEN MFG. CO., INC.

MAIN OFFICE AND FACTORY
MALDEN MASSACHUSETTS



NEW PRODUCTS

(continued)

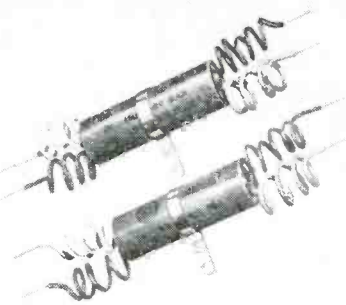

ventional type. The capacitor has a working-voltage rating of 150 volts and measures 1 1/8 inch in diameter and 2 3/8 inches long.

Oscillograph Power Pack (43)

ALLEN B. DU MONT LABORATORIES, Inc., 2 Main Ave., Passaic, N. J. The type 263-A high-voltage power supply comprises an r-f oscillator, step-up transformer, half-wave rectifier, filter and metering system.



Continuously variable from 5,000 to 10,000 volts with loads up to 200 microamperes the equipment can be used to modernize cathode-ray oscillographs for high-writing rates.

R-F Exciter (44)

COLLINS RADIO Co., Cedar Rapids, Iowa. Three new r-f exciter units



FOR HIGH FIDELITY AT LOW COST! -the UNIVERSITY TWEETER

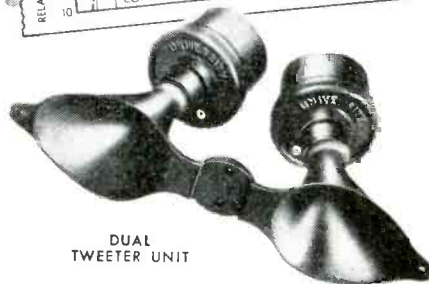
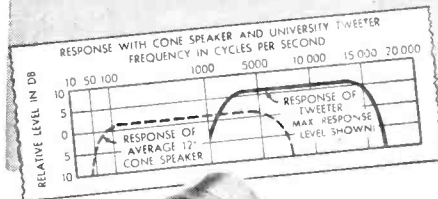

DUAL TWEETER UNIT

The reproduction of music and voice with breath-taking realism, is now possible with the new UNIVERSITY Dual Tweeter. Used in conjunction with any standard 12" cone speaker in FM and AM radio equipment and wide range phonograph amplifiers, it adds the brilliant "highs" so frequently carried through all stages of amplification, only to be lost in the bottleneck of a single unit reproducer. Frequency response is 2,000 to 15,000 cycles. The die-cast dual horn design offers wider dispersion angle than the conventional single cellular horn—horizontal distribution is 100°, vertical distribution 50°. A high pass filter with auxiliary high frequency volume control, permits easy connection by merely attaching two wires to the existing speaker. Compact dimensions require a mounting space only 2 3/4" high x 9 1/2" wide. Power handling capacity of the dual unit is 16 watts. For complete information write today to UNIVERSITY LOUDSPEAKERS, INC. 225 Varick St., New York 14, N. Y.

CABINET MODEL CONTAINS DUAL TWEETER UNIT

SINGLE UNIT TWEETER ONLY 2 3/4" DIAMETER

CLUSTERED TWEETERS FOR WIDE VERTICAL AND HORIZONTAL DISPERSION

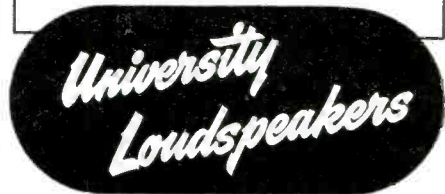

If you manufacture...

You can save 3 WAYS with...
Essex "Packaged" Wiring Harness

1. ENGINEERING

2. FIRST COST

3. INSTALLATION

Scores of manufacturers have found that they save *time, trouble and money* by turning their electrical wiring harness problems over to Essex specialists.

Essex *One-Source* service handles the intricate job of producing lighting, ignition and control harness assemblies *custom-built* to your exact specifications and *complete* with all manual and electrical control devices for quick, efficient installation.

Through intensive specialization in wiring harness assemblies, Essex has developed line production methods of manufacturing, assembly and inspection, for the economical production of high grade, individually tested, specially engineered assemblies.

Investigate Essex "One-Source" service today!

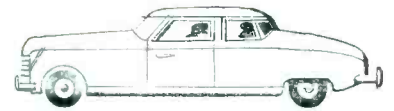

Automobiles

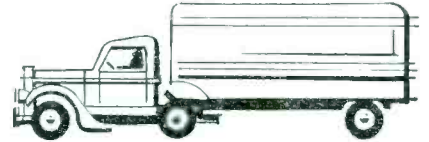

Trucks and Trailers



Buses and Trackless Trolleys

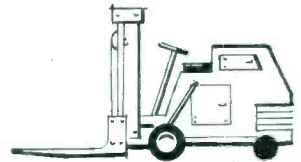

Industrial Electric Trucks

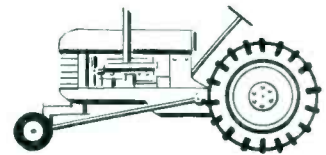

Tractors



Aircraft

ESSEX WIRE CORPORATION FORT WAYNE 6, INDIANA

Plants: Fort Wayne, Indiana; Detroit, Michigan; Anaheim, California
Warehouses* and Sales Offices: *Atlanta, Georgia; *Boston, Mass.; *Chicago, Ill.; Cleveland, Ohio; Dallas, Texas; Dayton, Ohio; *Detroit, Mich.; Kansas City, Mo.; *Los Angeles, Calif.; Milwaukee, Wisc.; *Newark, N. J.; Philadelphia, Pa.; *St. Louis, Mo.; *San Francisco, Calif.





3KW
Type 5530

10KW
Type 5541



**THEY'RE
TOPS
FOR FM!**



Western Electric FORCED AIR COOLED FM TRANSMITTING TRIODES

Their filaments are of thoriated tungsten — most efficient emitter for power tubes of these ratings. Their brazed and welded metallic joints, Kovar-to-glass seals, protected metallic vacuum "seal-off," and self-supporting filament structure all contribute to long, dependable service. Their terminal arrangements permit greatest flexibility of application. For full details, write to Graybar Electric Company, 420 Lexington Avenue, New York 17, N. Y., or . . .

ASK YOUR LOCAL

Graybar
BROADCAST REPRESENTATIVE

NEW PRODUCTS

(continued)

for radio amateurs are now in production. The type 310C-1 and 310C-2 units serve as variable-frequency oscillators, while the 10B exciter illustrated has an output of 15 watts. Calibration is directly in frequency and is accurate within 0.015 percent. Frequencies between 3.2 and 4.0 mc and those in harmonic relation up to the range 25.6 to 32 mc are available.

Aircraft Antenna Wire (45)

FEDERAL TELEPHONE AND RADIO CORP., Clifton, N. J. An insulated aircraft antenna wire that largely overcomes some of the undesirable

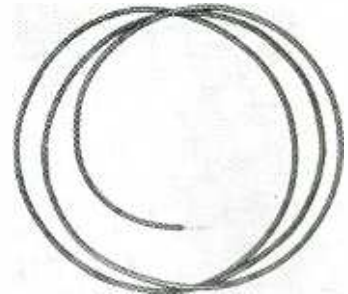

effects of precipitation static in aircraft communication is designated Intelin K-1064. A copperweld wire is covered with an insulating jacket of polyethylene, that helps to limit corona discharge.

Ribbon Microphone (46)

AMPERITE Co., 561 Broadway, New York 12, N. Y. A new ribbon microphone has a frequency range from 40 to 14,000 cycles within plus or minus 3 db. Pickup angle front and rear is 120 degrees. Standard equipment includes switch, 25-foot cable and plug.

Amplifier Units (47)

FAIRCHILD CAMERA AND INSTRUMENT CORP., 88-06 Van Wyck Blvd., Jamaica 1, N. Y. The Unitized Am-



*Division of Bendix Aviation Corporation

● This is typical of the wide use of PARAMOUNT paper tubes by leading manufacturers of electrical, radio and electronic products. With over 15 years of specialized experience, PARAMOUNT can produce exactly the shape and size tubes you need for coil forms or other uses. Square, rectangular, or round. *Hi-Dielectric, Hi-Strength, Kraft, Fish Paper, Red Rope*, or any combination, wound on automatic machines. Tolerances plus or minus .002". Made to your specifications or engineered for you.



SEND FOR
ARBOR LIST OF
OVER 1000 SIZES

Lists great variety of stock arbors. Includes many odd sizes. Write for Arbor List today.

Inside Perimeters
from .592" to 19.0"

PARAMOUNT PAPER TUBE CORP.

616 LAFAYETTE ST., FORT WAYNE 2, INDIANA

Manufacturers of Paper Tubing for the Electrical Industry

625 NA* VOLT-OHM-MIL-AMMETER

NOW

RANGES

- Six D.C. Volts to 2,500 at 20,000 Ohms per Volt.
- Six D.C. Volts to 5,000 at 10,000 Ohms per Volt.
- Six A.C. Volts to 5,000 at 10,000 Ohms per Volt.
- Six Current Ranges: 0-50 Micro-amperes to 0-10 Amperes.
- Three Resistance 0-2000-200,000 Ohms; 0-4 Megohms.
- Six Decibel Ranges: -30 to +69.
- Six Output Ranges to 5,000 Volts.



* High Ohms—Mirror Scale—Thirty-Nine Ranges

For the Man Who Takes Pride in His Work

The new Model 625NA, with 39 ranges and many added features, is the widest range tester of its type. Note the long mirror scale on the large 6" meter for easier more accurate reading. Resistance ranges to 40 megohms give you all the ranges

needed for general servicing, plus Television and FM. And with 10,000 ohms per volt A. C. you can check many audio and high impedance circuits where a Vacuum Tube Volt meter is ordinarily required. A proven super-service instrument.

Write for details today about Model 625NA and the many other new Triplet testers. Address Dept. E97



Triplet

ELECTRICAL INSTRUMENT CO. BLUFFTON, OHIO

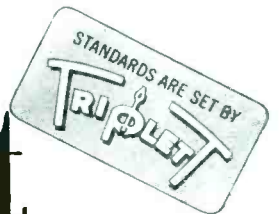



**VIBROMASTER TYPE K
PROFESSIONAL ARM**

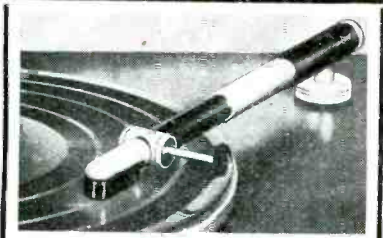

**for General Electric Variable
Reluctance Pick-ups Or the New
Pickering 120M Cartridge**

Resonance characteristic flat plus or minus 1/2 Db 40 to 1000 cycles (measured in 10 cycles steps throughout resonant range). 22 grams pressure when used with General Electric variable reluctance cartridge.

Flatwise bearing coil spring maintains pressure even under abnormal ambient changes.

"Morning After" handle prevents record damage when cueing. Pickup head will not move until entire weight is lifted.

Metal bearing face so constructed that bearing pin actually floats free.

Universal "One-hole" mount permits installation in any turntable, with hairline height adjustment.

Permanent stop prevents overswing to injure connections. Internal loop prevents damage.

For any lateral recording up to and including 16 inch, 78 or 33 1/3 rpm.

Arm will not "walk" even on 30 cycle modulated grooves.

Precision made and individually serial numbered for constant reference.

Finish is brushed aluminum and black to match any existing turntable.

Tests indicate that in conjunction with a normal General Electric Cartridge and a good equalizer, overall response will be exactly as the record is cut. The pick-up arm will neither introduce nor amplify lateral distortion and has no self-vibration.

PRICE net less cartridge \$3.50

GENERAL ELECTRIC CARTRIDGE . . \$ 4.77

PICKERING CARTRIDGE \$15.00

GENERAL ELECTRIC SPX-001

PRE AMPLIFIER \$ 5.95

GE Electronic Switch, Type YE-9. This instrument was designed for special electrical studies of wave-form, phase, frequency relationship, etc. It will show the simultaneous observation, for comparison, of two or more independent signals on the screen of a cathode-tube oscilloscope. \$59.95

Note: All prices are Net, F.O.B. N.Y.C. and are subject to change without notice.

Telephone: **3-HRE** LO. 3-1800

HARVEY
RADIO COMPANY INC.
103 West 43rd St., New York 18, N. Y.

plifier System consists of 12 units, several of which are currently in production. These units are designed to fit together in a variety of ways so as to serve the needs of the sound recording industry. The 620 power amplifier illustrated and the 621 microphone preamplifier are representative of the line, with essentially flat response from 30 to 15,000 cycles, low noise level, and distortion of less than 5 percent at full output.

**Wire Recorder
Mechanism**

(48)

WEBSTER-CHICAGO CORP., 5610
Bloomingdale Ave., Chicago 39, Ill.
The model 79 mechanism operates from socket power and records at 2 feet a second, rewinding at seven

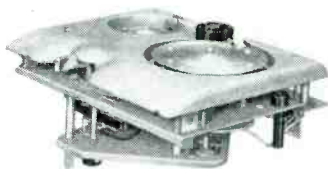

times that speed. A standard spool permits continuous recording for an hour. Shorter lengths are also available. The basic unit can be used by amateurs or experimenters.

**Miniature Pentode Power
Amplifier**

(49)

HYTRON RADIO AND ELECTRONICS
CORP., Salem, Mass. The type 6AR5
tube is a miniature version of the
type 6K6GT. It will be found useful
in applications where low heater
power and low plate current drain
are important considerations. The
lower heat dissipation makes the



TRACING CLOTH
for
HARD PENCILS

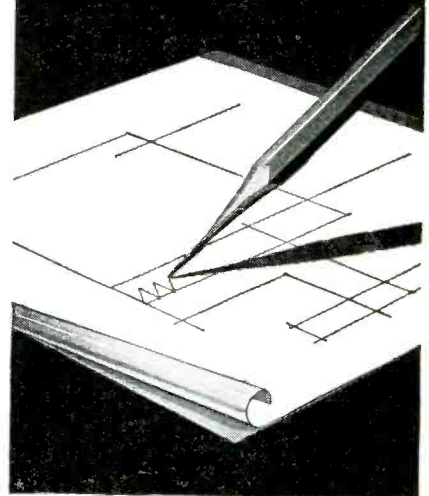

● Imperial Pencil Tracing Cloth has the same superbly uniform cloth foundation and transparency as the world famous Imperial Tracing Cloth. But it is distinguished by its special dull drawing surface, on which hard pencils can be used, giving clean, sharp, opaque, non-smudging lines.

Erasures are made easily, without damage. It gives sharp, contrasting prints of the finest lines. It resists the effects of time and wear, and does not become brittle or opaque.

Imperial Pencil Tracing Cloth is right for ink drawings as well.



**IMPERIAL
PENCIL
TRACING
CLOTH**



SOLD BY LEADING STATIONERY AND
DRAWING MATERIAL DEALERS EVERYWHERE.

ELECTRONIC

EQUIPMENT

BARGAINS

JOBBERS

WHOLESALEERS

MANUFACTURERS

Large inventories of valuable electronic tubes, devices and equipment are being offered by the WAA Approved Distributors listed herewith for your convenience. Alert commercial buyers are taking advantage of this big bargain opportunity. Why not fill *your* present and future requirements from these available stocks. Act now—while inventories still permit wide selection.

Purchase of this surplus equipment has been greatly simplified. The Approved Distributors appointed by WAA were selected on a basis of their technical background and their ability to serve you intelligently and efficiently. Write, phone or visit your nearest Approved Distributor for information concerning inventories, prices and delivery arrangements. You'll find you can "Save with Surplus."

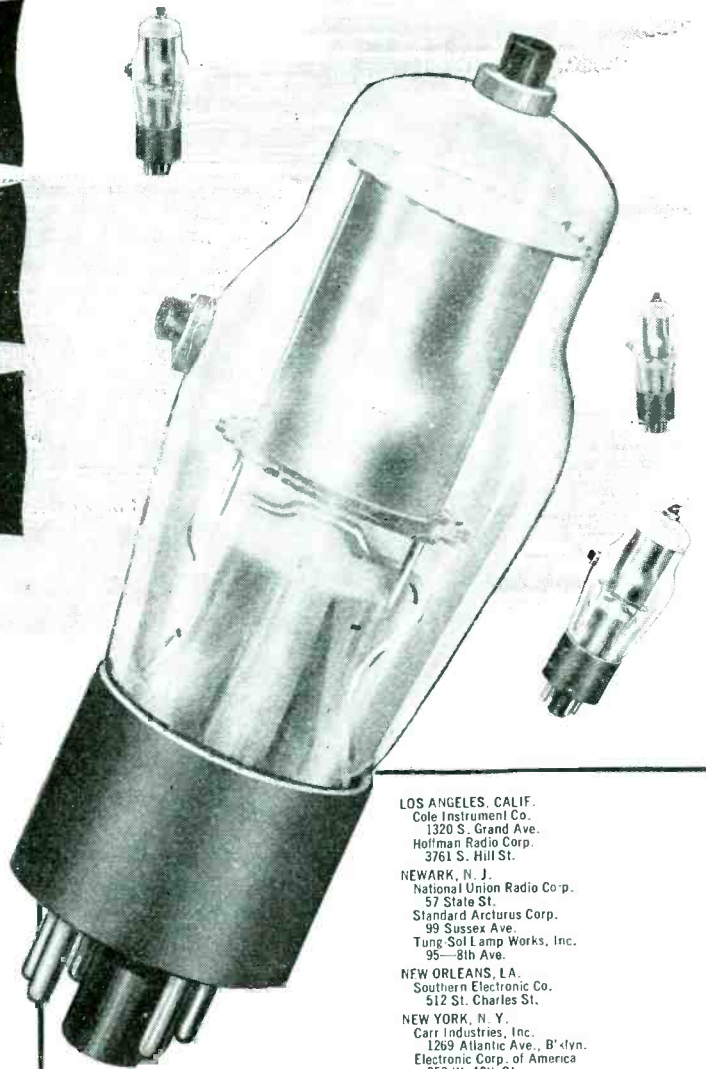

LOS ANGELES, CALIF.
Cole Instrument Co.
1320 S. Grand Ave.
Hoffman Radio Corp.
3761 S. Hill St.

NEWARK, N. J.
National Union Radio Co. p.
57 State St.
Standard Arculus Corp.
99 Sussex Ave.
Tung Sol Lamp Works, Inc.
95—8th Ave.

NEW ORLEANS, LA.
Southern Electronic Co.
512 St. Charles St.

NEW YORK, N. Y.
Carr Industries, Inc.
1289 Atlantic Ave., B'lyn.
Electronic Corp. of America
353 W. 48th St.
Emerson Radio & Phonograph Corp.
76—9th Ave.

General Electronics, Inc.
1819 Broadway
Hammarlund Mfg. Co., Inc.
460 W. 34th St.
Johanns & Keegan Co., Inc.
62 Pearl St.
Newark Electric Co., Inc.
242 W. 55th St.
Smith-Meeker Engineering Co.
125 Barclay St.

NORFOLK, VA.
Radio Parts Distributing Co.
128 W. Olney Road

ROCHESTER, N. Y.
W. & H. Aviation Corp.
Municipal Airport

SALEM, MASS.
Hylron Radio & Electronics Corp.
76 LaFayette St.

SCHENECTADY, N. Y.
General Electric Co.
Bldg. 267, I River Road

WASECA, MINN.
E. F. Johnson Co.
206 2nd Ave., S. W.

BOSTON, MASS.
Automatic Radio Mfg. Co., Inc.
122 Brookline Ave.
Technical Apparatus Co.
165 Washington St.

BUCHANAN, MICH.
Electro-Voice, Inc.
Carroll & Cecil Sts.

CANTON, MASS.
Tobe Deutschmann Corp.
863 Washington St.

CHICAGO, ILL.
American Condenser Co.
4410 N. Ravenswood Ave.
Balmont Radio Corp.
3633 S. Racine Ave.

EMPORIUM, PENNA.
Sylvania Electric Products, Inc.

FORT WAYNE, IND.
Essex Wire Corp.
1601 Wall St.

HOUSTON, TEXAS
Navigation Instrument Co., Inc.
P. O. Box 7001, Heights Station

OFFICE OF AIRCRAFT AND ELECTRONICS DISPOSAL

WAR ASSETS ADMINISTRATION



Offices located at: Atlanta • Birmingham • Boston • Charlotte • Chicago • Cincinnati • Cleveland
Dallas • Denver • Detroit • Fort Worth • Helena • Houston • Jacksonville • Kansas City, Mo. • Little Rock
Los Angeles • Louisville • Minneapolis • Nashville • New Orleans • New York • Omaha • Philadelphia
Portland, Ore. • Richmond • St. Louis • Salt Lake City • San Antonio • San Francisco • Seattle • Spokane • Tulsa

"DIE-LESS" DUPLICATING

SAVES MAN HOURS AND DELAYS

DIE ACCURACY WITHOUT DIES

Send for CATALOG

BENDER

SHEAR

BRAKE
DI-ACRO is Pronounced "DIE-ACK-RO"

The DI-ACRO System of METAL DUPLICATING Without Dies

DI-ACRO
DIE-LESS DUPLICATING

O'NEIL-IRWIN MFG. CO.

321 Eighth Avenue Lake City, Minnesota

NEW PRODUCTS

(continued)

new tube desirable for compact equipment. Details are given in Bulletin E 129.

Latching Relay (50)

SIGMA INSTRUMENTS, 70 Ceylon St., Boston, Mass. The type 6FZ2A2B relay is a multicircuit device that remains latched after initial operation until it is desired to release the

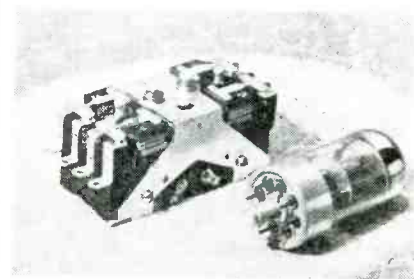

mechanism. The coils are wound for d-c operation and can be supplied in various resistance values up to 10,000 ohms. In one type of service, a relay can be adjusted to trip from the 50-volt charge on a 0.25-microfarad capacitor.

Frequency Shift Telegraph (51)

ERCO RADIO LABORATORIES, Inc., Garden City, N. Y. Frequency shift telegraph equipment is built in three units. The type 177-T exciter

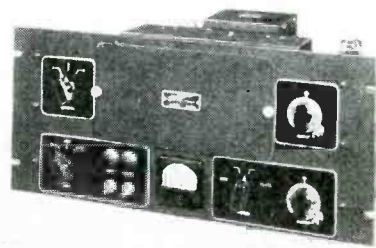

for keying transmitters illustrated is crystal controlled with provision for 3 frequencies. Mark and space frequencies are both adjustable. The type 216-S keyer-converter and type 87-R receiver complete the equipment necessary for a circuit.

Outdoor Microphone (52)

ST. LOUIS MICROPHONE Co., Inc., 2726 Brentwood Blvd., St. Louis 17, Missouri. The Outdoor Rugged Dynamic Microphone has been built specifically to weather outdoor serv-

ENGINEERED FOR EFFICIENT FM AND TELEVISION RECEPTION

Magic Wand Aerials for FM and television offer electrical efficiency possible only through the enthusiastic teamwork of Ward's top-drawer experimental laboratory, and production facilities.

As the world's largest producer of aerials for car and home, Ward also is pioneering in educating 33 million present, and prospective, FM and television receiver owners that a good outdoor dipole antenna is necessary if quality reception is to be enjoyed. Watch for our hard-hitting ads in the Saturday Evening Post and leading newspapers.

In addition to developing outstanding FM, television and automotive aerials, Ward also has design and production capacity available to take care of special aerial needs. Submit your aerial problems to us now for an efficient, and economical, solution.

WARD Magic Wand FM AND TELEVISION AERIALS



THE WARD PRODUCTS CORP.
1523 E. 45th Street, Cleveland 3, O.
Division of The Gabriel Company
EXPORT DEPT.: C. W. Brandes, Mgr.,
4900 Euclid Ave., Cleveland 3, O.
IN CANADA: Atlas Radio Corp.,
560 King St., W., Toronto, Ont.

WORLD'S LARGEST MAKER OF AERIALS FOR CAR AND HOME

Now Available---

A Line of PLASTICON* GLASSMIKE RF Transmitting Capacitors



(actual size)

Superior to mica capacitors because:

- Greater safety factor
(3500 VDC Operating; 7500 VDC Test)
- Lower RF losses
(See current rating below)
- More conveniently mounted
- Less chassis space
- Smaller overall volume
- Impervious to moisture
(The GLASSMIKE construction is 100% sealed)
- Silicone-fluid filled

The above advantages are possible by the use of the Type L film dielectric which has lower losses than mica.

● ● ●

TYPE LSG — PLASTICON* GLASSMIKES
3500 VDC Operating — 7500 VDC Test

Cat. No.	Cap. Mfd.	Dimensions		Current Rating in RF Amperes				List Price
		OD	Length	100 Kc	300 Kc	1 Mc	3 Mc	
LSG500.....	.00005	19/32"	x1-3/16"	.02	.05	.16	.47	\$1.50
LSG101.....	.0001	19/32"	x1-3/16"	.03	.09	.31	.94	1.50
LSG251.....	.00025	19/32"	x1-3/16"	.05	.25	.5	2.2	1.50
LSG501.....	.0005	19/32"	x1-3/16"	.15	.5	1.6	3.0	1.50
LSG102.....	.001	19/32"	x1-9/16"	.31	.94	2.5	4.5	1.70
LSG202.....	.002	3/4"	x1-9/16"	.62	1.9	4.5	7.0	2.45
LSG502.....	.005	3/4"	x1-3/4"	1.6	3.1	6.0	7.0	3.50
LSG602.....	.006	29/32"	x1-9/16"	1.9	3.5	6.2	7.0	3.75
LSG103.....	.01	29/32"	x1-3/4"	3.1	5.0	7.0	7.0	4.25



*PLASTICONS—Plastic Film Dielectric Capacitors

Condenser Products Company

1375 NORTH BRANCH STREET • CHICAGO 22, ILLINOIS

BRADLEY COPPER OXIDE RECTIFIERS

INSTRUMENT RECTIFIERS FOR BETTER A.C. SCALE



Vacuum-processed, gold-coated, full-wave bridge, Bradley instrument rectifiers allow more accurate determination of very low A.C. current. Especially designed for use where stability and permanence of calibration are important, "Coprox" rectifiers meet the most exacting requirements. Yet they cost no more than ordinary rectifiers — in most cases, less.

Temperature error is exceptionally low with Bradley rectifiers. Aging is practically nil. Shown above, CX2E4F rated up to 4.5 volts A.C., 3 volts and 5 milliamperes D.C.

Illustrated literature, available on request, shows more models of copper oxide rectifiers, plus a line of selenium rectifiers and photocells. Write for "The Bradley Line."

BRADLEY LABORATORIES, INC.

82 Meadow St. New Haven 10, Conn.

NEW PRODUCTS

(continued)

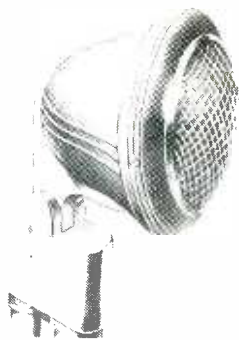

ive and mechanical jarring. Range of the microphone is 40 to 9,000 cycles and a variable-impedance output provides low to high adjustments, including 200 and 500 ohms.

Moisture Meter (53)

C. J. PATTERSON Co., 3947 Broadway, Kansas City, Missouri. The direct-reading electronic moisture



meter is applicable to any solid, liquid, granular, or powdered material. Automatic in action, it reports the percentage moisture in fifteen seconds.

Interval Timer (54)

MARITIME QUALITY HARDWARE CO., INC., Belfast, Maine. The motor-driven timer illustrated can be used for any program or interval with a range from a five-minute cycle to twenty-four hours. It has four separate circuits that can be con-

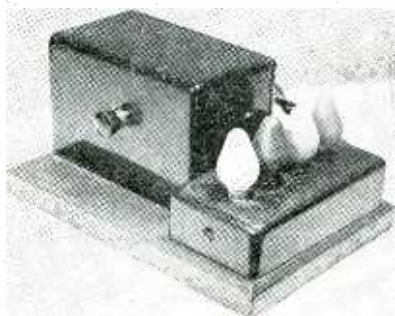

NOW— A QUALITY 2-KW INDUCTION HEATING UNIT

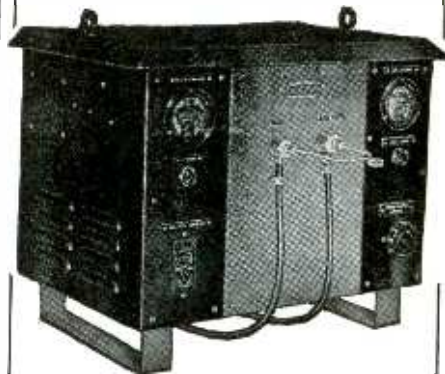

For Only **\$650.**

Never before a value like this new 2-KW bench model "Bombarder" or high frequency induction heater . . . for saving time and money in surface hardening, brazing, soldering, annealing and many other heat treating operations.

Simple . . . Easy to Operate . . .
Economical Standardization of
Unit Makes This New Low Price
Possible

This compact induction heater saves space, yet performs with high efficiency. Operates from 110-volt line. Complete with foot switch and one heating coil made to customer's requirements. Send samples of work wanted. We will advise time cycle required for your particular job. Cost, complete, only \$650. Immediate delivery from stock.

Scientific Electric Electronic Heaters are made in the following range of Power: 1-3-5-7½-10-12½-15-18-25-40-60-80-100-250-KW.—and range of frequency up to 300 Megs. depending on power required.

*Scientific
Electric*

Division of

"S" CORRUGATED QUENCHED GAP CO.

107 Monroe St., Garfield, N. J.

DEFLECTION COIL
SHELL CYLINDER

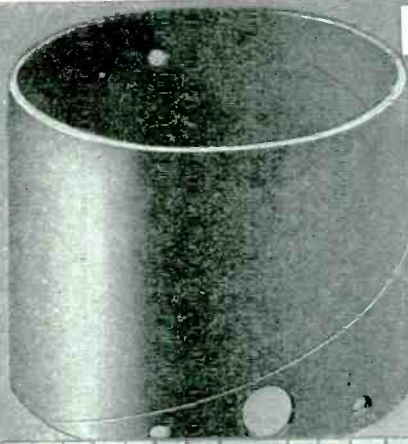

DEFLECTION
COIL CORE

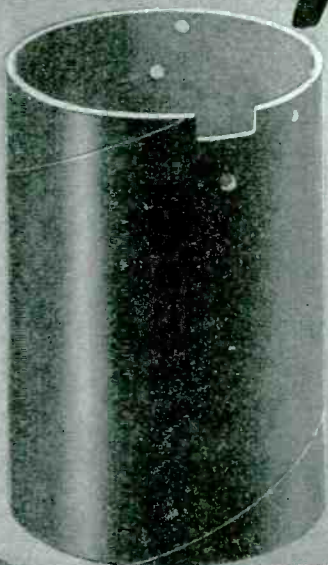

SHELL

DEFLECTION COIL
TERMINAL RING

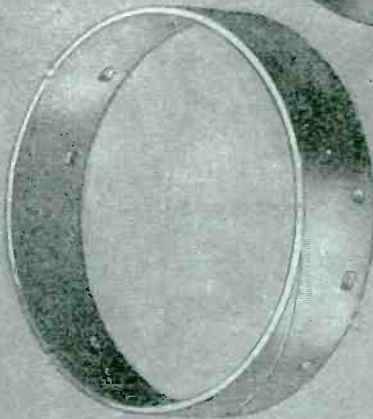

RETAINING RING



HALF SHELL



PLUNCHING AND
NOTCHING AS MAY BE
DESIRED.

Television RECEIVERS

PUNCHED COSMALITE*
COIL FORMS FOR..

A new and further step in the ever increasing use of these spirally laminated paper base, Phenolic Tubes. Performance based upon approximately seven years of research.

*

Other Cosmalite Types

#96 COSMALITE for coil forms in all standard broadcast receiving sets.

SLF COSMALITE for Permeability Tuners.

*

Spirally wound kraft and fish paper Coil Forms and Condenser Tubes.

*

Attractive prices. Fast deliveries. Inquiries given specialized attention.



* Trade Mark Registered.

The CLEVELAND CONTAINER Co.
 6201 BARBERTON AVENUE CLEVELAND 2, OHIO
 PRODUCTION PLANTS also at Plymouth, Wisc., Ogdensburg, N. Y., Chicago, Ill., Detroit, Mich., Jamesburg, Pa.,
 PLASTICS DIVISIONS at Plymouth, Wisc., Ogdensburg, N. Y. ABRASIVE DIVISION at Cleveland, Ohio
 New York Sales Office—1186 Broadway, Room 223
 IN CANADA—The Cleveland Container Canada Ltd., Prescott, Ontario

SIGMA 3 POSITION OUTPUT RELAY

FOR
CONTROL SYSTEMS
AND
SERVOMECHANISMS

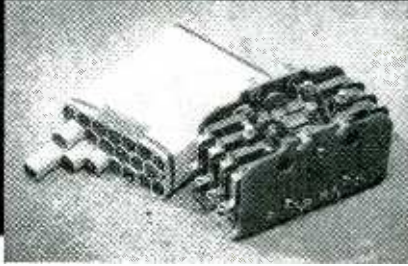

SIGMA TYPE 6 FX8A RELAY

Weight 8 Ounces

(Available Hermetically Sealed.)

This new relay by Sigma, already proven in months of development by prominent manufacturers of control and guiding equipment, overcomes many shortcomings previously inherent in relay-output control systems.

SPECIFIC ADVANTAGES

1. Positive snap centering or detent — no gradual motion.
2. True magnetic cancellation at balance — not affected by variations in standby current.
3. Exceptional sensitivity — approximately .005 watt differential power required per contact circuit.
4. Polarized magnetic circuit increases speed of action and facilitates discrimination as to polarity of error.
5. Fully balanced moving system withstands vibration to exceptionally high degree.
6. Flexible contact structure (maximum shown above) with substantial load handling ability (nominal rating 5 amp 110 Volts A.C. per contact).

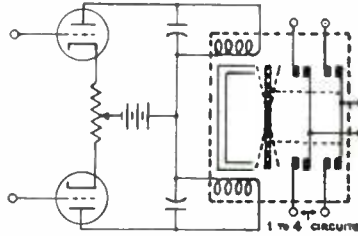

Sigma Instruments, Inc.

Sensitive RELAYS

62 Ceylon St., Boston 21, Mass.

NEW PRODUCTS

(continued)

trolled on and off with any commercial accuracy desired. When used on 115-volt circuits each set of contacts will carry a maximum of 30 amperes.

Automatic Voltage Regulator

(55)

RICHARDSON-ALLEN CORP., 15 W. 20th St., New York 11, N. Y. The model 442A automatic voltage regulator maintains a constant d-c out-



put voltage regardless of ampere load current. An easily handled unit, it is designed for 115-volt, single phase, 50 or 60-cycle a-c input, and 1 to 9 volt d-c output.

Permanent-Magnet Motor (56)

AMPEX ELECTRIC CORP., 1155 Howard Ave., San Carlos, Calif. A new line of permanent-magnet motors



derived from wartime experience is now available. The 25-watt unit illustrated weighs 15 ounces. A complete range of speeds, voltages, shaft sizes and mounting-flange designs can be supplied.

Miniature Tube Shield (57)

STAVER MFG. Co., 33-21 85th St., Jackson Heights, N. Y. Mini-Shields come in three lengths and of a diameter to fit the smaller



NEW! 5Q1 - MINIATURE Selenium Rectifier..

Here's the 5Q1, the newest SELETRON miniature selenium rectifier — built on aluminum.

Check These Features

- STARTS INSTANTLY
- RUNS COOL
- WILL NOT BREAK
- TAKES MOMENTARY HEAVY OVERLOADS
- BOOSTS PERFORMANCE
- EASILY INSTALLED
- EACH UNIT FACTORY TESTED
- HIGH EFFICIENCY ASSURES COMPACTNESS
- NORMALLY LASTS LIFETIME OF SET

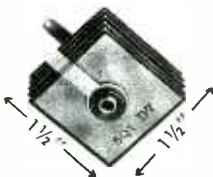

5Q1 — 250 mil 5-plate stack. 1 1/2" x 1 1/2" x 7/8". Maximum AC input 130 volts r.m.s.; rectifier voltage drop approximately 5 volts r.m.s. Recommended input filter capacitor 80 m.f.d.

5Q1 now joins the family of SELETRON miniature selenium rectifiers which include the 5P1, 150 mil 5-plate stack, 1 3/16" x 1 3/16" x 7/8" and the 5M1, 100 mil 5-plate stack, 1" x 1" x 7/8".

For maximum efficiency, reliability and service, specify SELETRON miniature selenium rectifiers.

WRITE TODAY FOR FULL INFORMATION. ADDRESS DEPT. S-43.

Our new bulletin
"SELETRON
Selenium
Rectifiers"
will soon be off
the press. Write
for your copy now

RR SELETRON DIVISION **RR**
RADIO RECEPTOR CO., Inc.
Since 1922 in Radio and Electronics
251 WEST 19th STREET NEW YORK 11, N. Y.

ANOTHER KAY DEVELOPMENT

THE MEGA-MATCH.... MEASURES REFLECTED ENERGY...

A BASIC
LABORATORY
INSTRUMENT

GIVES VISUAL DISPLAY...

FEATURES

- 10 to 250 MC and up. Complete television and FM coverage.
- Completely electronic. No slotted lines, moving parts, bridges, or other frequency sensitive devices such as directional couplers.
- Precision frequency meter.
- Saves engineering time—Visual display presents instantly data which would take hours to tabulate.
- Can be adapted for balanced lines.



COMPLETELY ELECTRONIC

This unique instrument presents a visual display of REFLECTED energy over any band up to 30 MC. By the use of the MEGA-MATCH it is possible to instantly observe and measure mismatches. Thus this instrument will check transmission lines, antennas, input and output impedances of amplifiers, converters, transformers, etc.

Price: \$695 F.O.B. Newark, N. J.

* * * * *

WIDE RANGE SWEEPING OSCILLATOR THE MEGA-SWEEP.....

Reference August 1947
"Electronics" page 112.



USES:

- Testing Television Systems and Components.
 - Testing Radar Systems and Components.
 - Instructional Purposes in Schools and Universities.
 - Designing Wide-Band i.f. Amplifiers.
 - Designing Filter Networks.
 - Production Testing of F. M. and Television Equipments.
 - As a Signal Source of Extraordinary Range (Unmatched by any existing commercial signal generator.)
 - As a cw high frequency oscillator.
 - Self-contained Regulated Power Supply—117 Volt 60 Cycle operation—Size 9" x 17" x 11"—Weight 35 Pounds.
- Price \$395 F.O.B. Newark, New Jersey.

DISPLAYS PASS BAND

Continuous frequency coverage up through the color television bands



Shows at a glance the response of any network or amplifier. Eliminates the tedious point to point analysis. Saves engineering time and stimulates research. Valuable for television production alignment.

FEATURES:

- CARRIER FREQUENCY**
50 kilocycles to 500 megacycles & up.
- FREQUENCY SWEEP**
From 30 megacycles to 30 kilocycles throughout the complete spectrum.
- CONTINUOUSLY VARIABLE ATTENUATOR**
- LOW AMPLITUDE MODULATION WHILE SWEEPING**
Less than 0.1 DB per megacycle
- PRECISION WAVEMETER**

KAY ELECTRIC COMPANY

34 Marshall St.

Newark 2, New Jersey

Telephone: Market-3-4337

Manufacturers of THE MICRO-PULSER and other specialized Electronic Instruments.

**CURRENT
CONVERSION**
WITH
ATR QUALITY
PRODUCTS



ATR
"A"

BATTERY ELIMINATORS
For DEMONSTRATING and
TESTING AUTO RADIOS

New Models . . . Designed for Test-
ing D.C. Electrical Apparatus on
Regular A.C. Lines. Equipped with
Full-Wave Dry Disc Type Rectifier,
Assuring Noiseless, Interference-
Free Operation and Extreme Long
Life and Reliability.

- Eliminates Storage Batteries and
Battery Chargers.
- Operates the Equipment at Maxi-
mum Efficiency.
- Fully Automatic and Fool-Proof.
- Type 60-ELIA . . . Rated Output
6.3 Volts at 6.5 Amperes.
Dealer Net Price \$22.80
- Type 120C—ELIO . . . Rated Out-
put 6.3 Volts at 14 Amperes.
Dealer Net Price \$37.20



ATR
**AUTO
RADIO
VIBRA-
TORS**

Designed for Use in Standard Vibra-
tor-Operated Auto Radio Receivers.
Built with Precision Constructon for
Longer Lasting Life. Prices are
app. 15% lower.

ATR
**STANDARD
AND HEAVY
DUTY
INVERTERS**



For Inverting D. C. to A. C.
Specially Designed for Operating
A.C. Radios, Television Sets, Ampli-
fiers, Address Systems, and Radio
Test Equipment from D.C. Voltages
in Vehicles. Ships, Trains, Planes
and in D.C. Districts.

Write for New ATR Catalog—Today!

AMERICAN TELEVISION AND RADIO CO.
Quality Products Since 1931
SAINT PAUL, MINNESOTA — U. S. A.

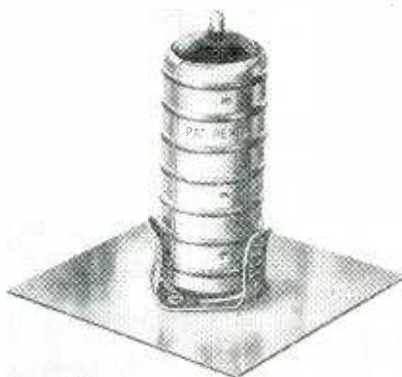

miniature tubes. An expansion
joint allows the shield to be pushed
over tubes of larger diameters.
Free air circulation is provided by
dimples that space shield from tube.

Spectroph Source (58)

APPLIED RESEARCH LABORATORIES,
7707 Michigan Ave., Detroit 10,
Mich. Electrical discharge equip-
ment for spectrochemical analysis
is available for high quantitative

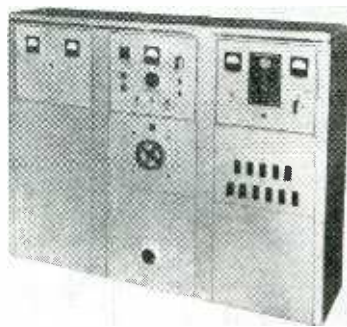

precision. A high voltage source
uses 240 spark trains per second
with short duration and the low
voltage source uses 60 arc dis-
charges a second of long duration
for high sensitivity.

Portable Volt-Ohmmeter (59)

HICKOK ELECTRICAL INSTRUMENT
Co., 10527 Dupont Ave., Cleveland
8, Ohio, introduces the Model 214
portable, battery-operated elec-
tronic volt-ohmmeter to eliminate
the need for plugging into an a-c
line. It is built for self-checking
of battery condition at any time and
can be used for 1,350 complete cy-
cles of 4-minute operations. Ranges



**DESIGN
FOR
DOING**

... specify
"SPINTITES"

One of the surest ways of
sustaining assembly line speed
is to standardize on Spintite
wrenches. Made to meet the par-
ticular problems of radio and
electrical assembly and repair,
they're designed for precision
performance, volume production,
durability and ease of operation
with a minimum of skill.

Built like a screwdriver, the
Spintite shaft readily reaches
difficult assembly spots, and it is
partly hollowed to permit tight-
ening of nuts through which the
bolt protrudes.

Available with either fixed
or chuck-type handle, Spintites
can be had to fit square, knurled
or hex nuts in sizes from 3/16"
to 5/8". For the radio and electri-
cal industry's three requisites in
tools, speed, accessibility and
quantity — specify Spintites.

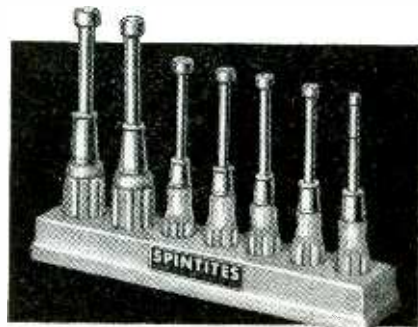

T-73 SET, has 7 sizes of hex heads.
Shock-proof handles, and cold forged
sockets assure safety and strength.
OVER 40 YEARS OF MASTER TOOLMAKING



STEVENS-WALDEN, INC.
Worcester • Massachusetts

Wherever you Employ Magnets,
Check with us on the
Advantages of using

ARNOLD

PERMANENT MAGNETS



As electrical constituents go, permanent magnets are relatively new. They made tremendous advances within the past decade, especially in the communications and aviation industries, and in the general fields of instruments, controls, meters and mechanical holding devices.

Many of these uses were problems that just couldn't be solved until permanent magnet materials were developed to do the job—a work of pioneering to which Arnold contributed a heavy share. Many other applications were those where permanent magnets supplanted older materials because of their inherent ability to save weight, size and production time, as well as greatly improve the performance of the equipment.

To these advantages, Arnold Permanent Magnets add another very important value—standards of quality and uniformity that are unmatched within the industry. Arnold Products are 100% quality-controlled at every step of manufacture. What's more, they're available in all Alnico grades and other types of magnetic materials, in cast or sintered forms, and in any shape, size or degree of finish you need.

● Let's get our engineers together on *your* magnet applications or problems.

THE ARNOLD ENGINEERING CO.



Subsidiary of

ALLEGHENY LUDLUM STEEL CORPORATION

147 East Ontario Street, Chicago 11, Illinois

Specialists and Leaders in the Design, Engineering and Manufacture of PERMANENT MAGNETS

W&D 1296

For
Front Bulb Replacement

Gothard
SERIES 1110

INDICATOR LIGHTS

Available in 2 Lengths

The Series 1110 Indicator Light comes in styles to accommodate either the long bulb or the small round bulb. Unscrew the jewel on the front and there's the bulb—no need to mess around behind the panel. All brass construction except nut and lock washer. Parts heavily plated. Not affected by heat. Furnished with famous Gothard rigid, non-short terminals; fibre space washer; lock washer and nut. Requires 11/16" mounting hole. Jewel is 1/2" dia., either faceted or smooth glass; colored red, green, amber, blue, opal, clear.

Gothard Division
E. F. JOHNSON COMPANY
Waseca, Minn.

JOHNSON
a famous name in Radio

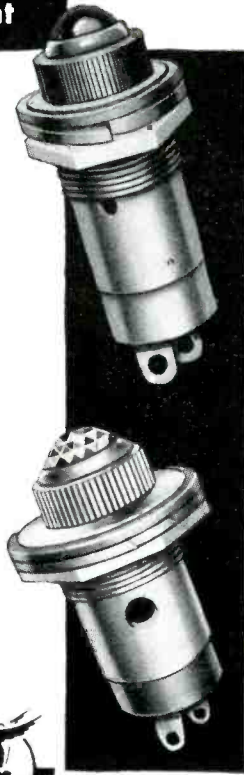

Johnson-Gothard catalog fully describes this Indicator Light and many others—write for it.



include a-c or d-c voltage up to 1,200 v.; and resistance up to 1,000 megohms.

Literature

(60)

Magnetic Relays. R-B-M Division,, Essex Wire Corp., Logansport, Indiana, has issued Bulletin 570 covering general purpose a-c and d-c relays. Complete descriptions, with photographs and diagrammatic dimensions, are given.

(61)

Vibrator Supply. Raytron Inc., 407 North Jackson St., Jackson, Mich. Portable radio or other electronic equipment can be furnished high voltage from a unit that is complete with input and output leads and screw studs for mounting. The new type vibrator is practically noiseless. Suggested circuit arrangements are given in the 3-page brochure.

(62)

Engineering Literature Service. T. A. Farrell Jr., 141 Welch's Point Road, Milford, Conn. Technical manuals, engineering surveys, service literature, and similar publication work are among the services offered to electronic engineers and industries.

(63)

House Organ. Consolidated Engineering Corp., 620 N. Lake Ave., Pasadena 4, Calif., issues a small publication known as CEC Recordings. In it are reported facts of interest about the line of mass spectrometers, recording oscillographs, and similar research

Baer
can supply your vulcanized
and phenol fibre fabrications



SEND BLUEPRINTS
AND SPECIFICATIONS—
NO OBLIGATION!

When you use these tough, lightweight and inexpensive parts, you build their many advantages into your own product. Fabricated to order, BAER FIBRE washers, special shapes, terminal boards, and other parts are accurately and uniformly produced to specification in any quantity. Selection of grades by physical and electrical qualities, permits application to a wide range of operating conditions and requirements. Investigate now!

LITERATURE ON REQUEST

**N. S. BAER
COMPANY**

MONTGOMERY ST., HILLSIDE, N. J.

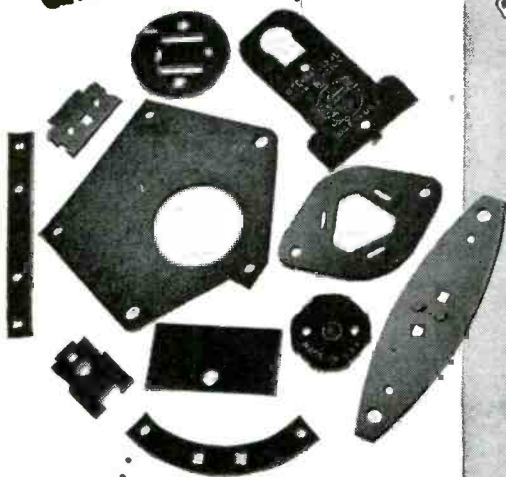

* Baer fibre is versatile... can be stamped, punched, drilled, tapped, milled, sheared, sawed and shaved to specifications

New! PALNUT SHIELD CAN FASTENER*



- Lower Assembly Cost
- Strong Positive Grip
- No tolerance problems

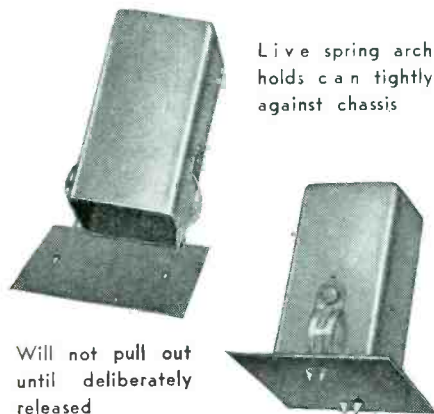

Live spring arch holds can tightly against chassis

Will not pull out until deliberately released

• A quick snap of the Palnut Shield Can Fastener into the chassis provides a secure job—faster, cheaper than other fastening methods. Good ground contact is maintained. May be used on any chassis thickness. **SAMPLES** and data on Palnut Shield Can Fasteners sent upon request on your company letterhead.

* Pat. Pending

The PALNUT Co.
77 CORDIER ST., IRVINGTON 11, N. J.



Five Uses for Cellusuede FLOCK

- 1 Coating cabinet interiors dissipates reflections and adds acoustical qualities.
- 2 Coating the edges of adjoining parts before assembly eliminates vibration.
- 3 Coating phonograph turntables adds a soft non-scratching cushion for records.
- 4 Coating cabinet bases lends a soft, velvety "feel" and protection to table and desk tops.
- 5 Coating wire grills adds a smart finish at low cost.

A trial application will show you how easily this versatile material may be handled . . . how practical it is for the above mentioned uses.



Both Cotton and Rayon Flock are available immediately in a variety of colors.

Write for Free Booklet and Prices

CP
Cellusuede Products, Inc.
ROCKFORD, ILLINOIS



MODEL 2B 0.45
Actual size illustrated

RECHARGEABLE • NON-SPILL

VITAMITE

1 OZ. BATTERIES
(Smaller Than 2 Pen-Lights)

IDEAL FOR USE WITH

Miniature And Sub-Miniature Filament Type Tubes for HEARING AIDS, PORTABLE EQUIPMENT, ETC.

LARGER MODELS ALSO AVAILABLE
Write for Data and Literature

THE VITAMITE COMPANY

227 West 64th Street New York 23, N. Y.

WHAT MAKES A MAILING CLICK?



McGRAW-HILL
DIRECT MAIL LIST SERVICE

Advertising men agree . . . the list is more than half the story. McGraw-Hill Mailing Lists, used by leading manufacturers and industrial service organizations, direct your advertising and sales promotional efforts to key purchasing power.

In view of present day difficulties in maintaining your own mailing lists, this efficient personalized service is particularly important in securing the comprehensive market coverage you need and want. Investigate today.

McGraw-Hill Publishing Co., Inc.
DIRECT MAIL DIVISION

330 West 42nd Street New York 18, New York

FABRICATED SHEET METAL PRODUCTS

to your specifications . . .

COMPLETE facilities under one roof for quantity mass production—including welding, baking and finishing. Whistler and Wiedermann equipment for short runs. Tool and die engineering and designing.

Substantial sheet steel inventories permit speed, service and cooperation. Large assortment of stock and special dies for the radio and electronic field. Production and engineering under the personal direction of Mr. E. B. Gunzburg, president—who has had 33 years' experience in sheet metal fabrication.



Quality chassis, metal cabinets, instrument housings, panels, boxes, metal parts and stampings—sample models—in stainless steel or in any metal or any gauge. Close tolerances guaranteed.

Send your blueprints and requests for prompt attention and quotations.

ART-LLOYD METAL PRODUCTS CORP.

2973 Cropsey Ave

Brooklyn 14, N. Y.

Telephone: ESplanade 2-0681

. . . a complete range of POWER TRANSFORMERS capacities to 50 KVA

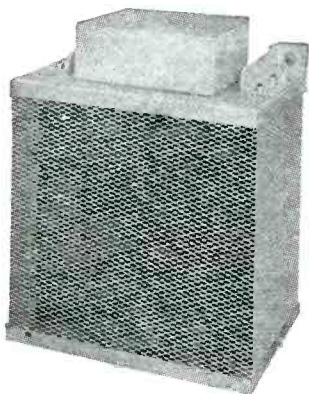

No ELECTRAN Transformer is considered a "stock" model. Each is built to function with maximum efficiency for a specific installation.

Electran production facilities are completely flexible and are especially geared for the rapid completion of small or medium quantities. Engineering facilities permit production of Transformers to your exact specifications or prints, or the complete design and engineering of Transformers to meet your specific needs when your prints are not available. Your inquiries are invited.

ELECTRAN MFG. Co.

4589 ELSTON AVE.

CHICAGO 30, ILL.

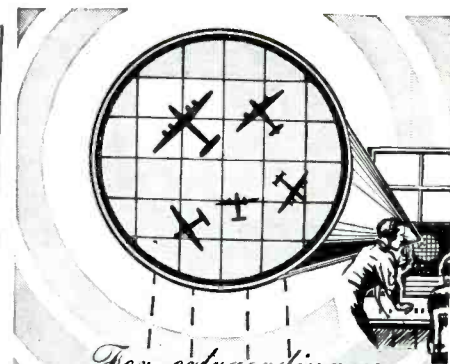

For extraordinary electrical performance

Use SILVER GRAPHALLOY*



THE GRAPHALLOY MATERIAL

BRUSHES



CONTACTS

in BRUSHES

for high current density • minimum wear • low contact drop • low electrical noise • self-lubrication

in CONTACTS

for low resistance • non-welding character

GRAPHALLOY works where others won't! Specify GRAPHALLOY with confidence.

*A special silver-impregnated graphite

GRAPHITE METALLIZING CORPORATION

1055 NEPPERHAN AVENUE, YONKERS 3, NEW YORK

equipment manufactured by the company. The quarterly publication will be of interest to many engineers.

(64)

Radar Components. Carl W. Schutter, Rockville Centre, N. Y. Factory representative H. L. Hoffman & Co., 673 Broadway, New York 12, N. Y. Six illustrated pages show the line of chokes, choke flanges, coaxial connectors, and component parts available for radar use. Special components can also be furnished.

(65)

Industrial Tubes. National Electronics, Inc., Batavia Ave., Geneva, Ill. A new technical data book in loose-leaf form gives rating and application information on eleven rectifier and thyatron types suitable for welding or motor control and industrial rectifier applications.

(66)

Insulation Tester. James G. Bidle Co., 1316 Arch St., Philadelphia 7, Pa. A new plug-in Megger insulation tester requires no hand crank to cover 2,000 megohms at 1,000 volts. Bulletin 21-46-14 tells about it.

(67)

Universal Parts. General Electric Co., Syracuse, N. Y. A 24-page brochure on universal electronic parts, ESD-93, lists price, specifications, and other data on 16 parts in the line that includes resistors, controls, antennas, and the variable-reluctance pickup as well as loudspeakers.

(68)

Selenium Rectifiers. Selectron Div., Radio Receptor Co., Inc., 251 West 19th St., New York 11, N. Y., announces a new 8-page bulletin on the subject of selenium rectifiers for direct-current requirements, including electrical characteristics, dimensions, and weights.

(69)

Big Tubes. Radio Corp. of America, Harrison, N. J. The Quick Se-

CURRENTLY FROM
SORENSEN & COMPANY, INC.
Manufacturers of
VOLTAGE REGULATORS, NOBATRONS & ELECTRONIC APPARATUS
AT STAMFORD



RUNAWAY VOLTAGES STOPPED AT 1/10 OF 1%

Rated performance of Model 1750-S guarantees delivery of output line voltages at a regulation accuracy of 0.2% under varying load. However, in actual tests of this unit voltage stabilization was held to within 0.1% under full operating conditions. This conservative safety rating of 0.2% is typical of all Sorenson performance factors.

Input voltage range.....	95-125
Adjustable output between.....	110-120
Load range.....	200-2000 VA
Regulation accuracy.....	0.2%
Harmonic distortion.....	2% max.
Recovery time.....	6 cycles
Input frequency range.....	55-65 cycles

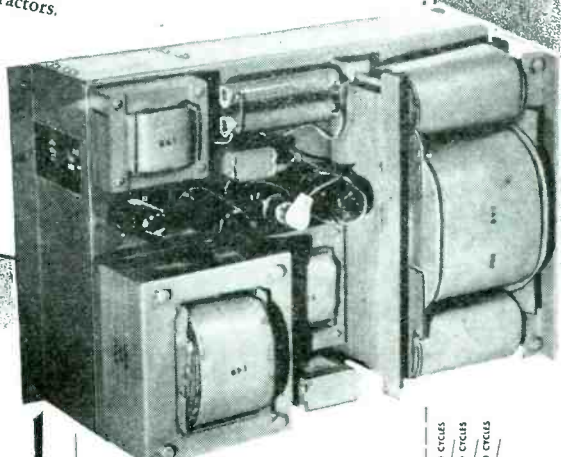

IT IS "A NATURAL" FOR CONTROLLING VOLTAGES IN LABORATORIES, ASSEMBLY LINE TESTING AND AS A COMPONENT OF YOUR ELECTRICAL UNIT.

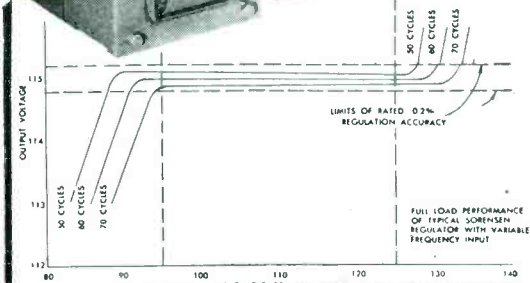

FULL LOAD PERFORMANCE OF TYPICAL SORENSON REGULATOR WITH VARIABLE FREQUENCY INPUT

Write

for the latest in electronic developments

Send me the Electronics Journal "Currently" regularly in addition to the resume on "Electronic Batteries."

NAME _____ TITLE _____

COMPANY _____

ADDRESS _____

SORENSEN & COMPANY, INC.

375 FAIRFIELD AVE. • STAMFORD, CONN.

MINIGLASS* QUARTZ CRYSTAL UNITS †

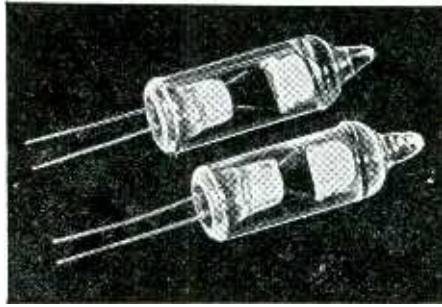

SHOWN ACTUAL SIZE

Compact — hermetically sealed — high performance — for multiple applications in the range of 2,500 to 10,000 kilocycles with a tolerance of ± 250 cycles at room temperature . . . MINIGLASS* crystals are designed for your low cost quantity production items. Immediate delivery.

Manufacturers of Radio Quartz Crystals.

MELVIN L. SMITH LABORATORIES
KANE, PENNSYLVANIA

*Trade Mark †Patent applied for

*Have you ever seen the
INSIDE of an EXPLOSION?*

Seeing now made possible by remarkable new electronic features, embodied in

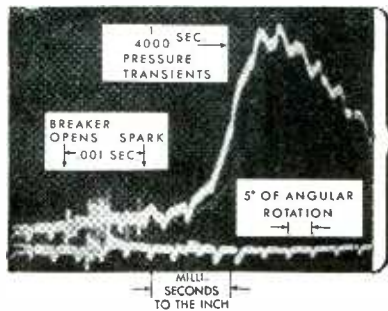

PRESSUREGRAPH with Syncro-Marker

Reproduces on oscillograph screen, accurate picture of pressures during and after explosion, relates pressure variations to time, top dead center, angular velocity, etc. See pressure-time characteristics of automotive, jet and Diesel engines, also compressors, pumps, etc. Operates over range from static up to 10,000 cycles at pressures from 0 to 10,000 lbs.

Send for description and full engineering data.

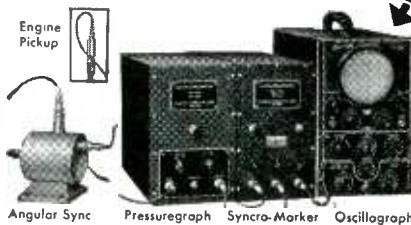

ELECTRO PRODUCTS LABORATORIES

549 W. Randolph St., Chicago 6, Ill.

Phone ST ate 7444

OLYMPIC

STANDARD TRANSFORMER CASES



★ Now available in quantity, OLYMPIC standardized transformer cases are specifically designed to meet all normal requirements where standard cases are used. Construction is rigid, with rounded corners, and tight-fitting covers top and bottom. OLYMPIC standard transformer cases can be handled with pierced covers, studs, brackets or channels. Inquiries are invited—write for illustrated bulletin—no obligation.

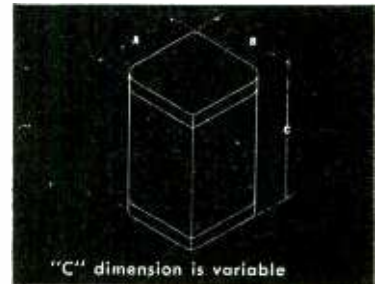

CORE	CASE	A	B	C
E1-21	1	1 1/4"	1 1/4"	2 1/4"
E1-625	2	1 1/8"	1 1/8"	2 1/4"
E1-75	3	2 1/4"	2 1/4"	2 1/4"
E1-11	4	2 1/2"	2 1/2"	3 1/2"
E1-12	5	3"	2 1/4"	3 2/32"
E1-3A	6	3 1/4"	3"	3 1/32"
E1-112	7	3 3/4"	3 1/4"	4 1/32"
E1-125	8	3 3/4"	3 1/2"	4 1/32"
E1-137	9	3 3/4"	3 1/2"	4 1/32"
E1-13	10	4 1/4"	4 1/4"	5 1/32"
E1-151	11	5"	4 3/4"	5 1/32"
E1-36	12	5 1/4"	4 3/4"	6 1/32"

CRAFTSMANSHIP



IN METAL PARTS

OLYMPIC

TOOL & MFG. CO., INC.

39 CHAMBERS ST. NEW YORK 7, N. Y.

lection Guide offers technical data on more than 200 transmitting and industrial tubes. Dimensions, ratings, and other essential information are presented in abridged form.

(70)

Mass Spectrometer. Consolidated Engineering Corp., 620 N. Lake Ave., Pasadena 4, Cal. Copies of a 20-page, illustrated folder, describing the model 21-102 mass spectrometer, are now available. The mechanism provides a direct approach to the determination of mixture composition by the sorting and counting of molecules.

(71)

Tube Data. Hytron Radio and Electronics Corp., 76 Lafayette St., Salem, Mass. Transmitting and Special-purpose tubes have been cataloged in a four-page brochure that gives complete operational data and socket connections.

(72)

Radar. Raytheon Mfg. Co., Waltham, Mass. A slick-paper 12-page booklet in two colors covers the highlights of a navigational radar for merchant shipping known as Mariners Pathfinder.

(73)

Amateur Antennas. Workshop Associates Inc., 66 Needham St., Newton Highlands, Mass. Broad-band antennas and accessories are summed up in a recently printed 4-page pamphlet that gives descriptions, characteristics, and prices of the line most suitable for amateur use.

(74)

Control Relay. Niagara Electron Laboratories, Andover, N. Y. Bulletin T-1/9-46 describes the Thermocap relay that is extremely sensitive to minute changes in electrical capacitance. Many applications are possible in industrial control.

(75)

Vibration Mountings. Lord Manufacturing Co., Erie, Pa. The chief features and applications of Mul-



SPEAKERS

make the difference

● The finest receiver (from every other design standpoint) can only be as good as the speaker it houses. G-E speakers have been built to make good receivers better. The check list of outstanding features given below will tell the story to your design engineers — the resultant higher quality performance will tell the story to your consumer market.



Aluminum Foil Base Voice Coil

Better Tone Quality and Reproduction • Unusually High Wattage Handling Capacity • No Warping of Voice Coil • Unaffected by Humidity and Ambient Temperatures • Free From Ageing Due to Overloading Voice Coil.



Alnico V Permanent Magnets

Expands Design Possibilities • Overall Greater Efficiency • Greater Sensitivity • Reduction in the Possibility of Mechanical and Electrical Failures.

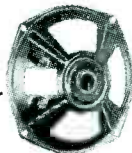

All Weld Construction

Better Controlled Airgaps • Increased Efficiency • Rigidity—Strength—Durability.

Consult General Electric now, for your 1947 speaker requirements. Write to: General Electric Company, Electronics Department, E6810, Syracuse 1, N. Y.

GENERAL ELECTRIC

168 E 4

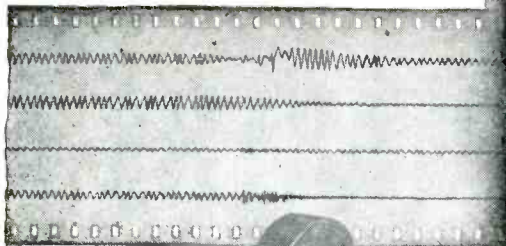

DETAILED EXAMINATION OF CONTINUOUS FILM

The AVIMO Film Assessor has been designed for the projection of 35mm or 16mm Film of Oscillograph Traces or other phenomena. Frames are projected singly or continuously on to an optically flat surface and magnification is from x12 to x36. Projection of successive frames is accurate to within $\pm .04''$ at maximum enlargement.

AVIMO Continuous Film Recording Cameras provide permanent records of oscillograph traces.



AVIMO Ltd., TAUNTON
(Eng.) Tel. 3634

Designers and Manufacturers of
Scientific Cameras

10490C

precision-fabricated PLASTIC PARTS

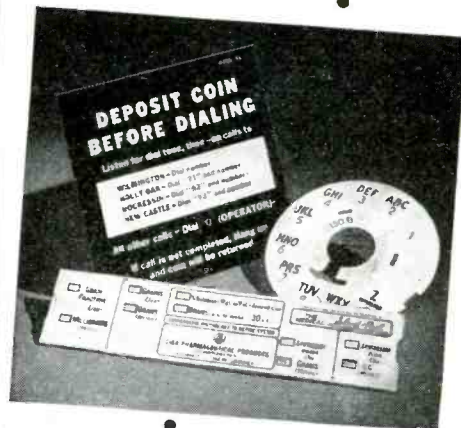

**QUALITY and SERVICE
AT A PRICE
THAT'S RIGHT**

With more and more manufacturers switching to plastic parts to improve the appearance and performance of their products, it is significant that so many look to Sillcocks-Miller for the quality and service they want. This organization of specialists is recognized throughout the industry for its skill in fabricating plastic parts to close tolerances and its reputation for unvarying quality. With complete facilities to meet your requirements . . . no matter how large or small . . . Sillcocks-Miller offers you the dependable source you want for plastic parts and service, at a price that's right.

Write for illustrated booklet or phone
South Orange 2-6171 for quick action.

THE SILCOCKS-MILLER CO.

10 West Parker Avenue, Maplewood, N. J.
Mailing Address: South Orange, N. J.

SPECIALISTS IN HIGH QUALITY, PRECISION-MADE
PLASTICS FABRICATED FOR COMMERCIAL,
TECHNICAL AND INDUSTRIAL REQUIREMENTS.

LEACH RELAYS

BETTER CONTROLS THROUGH BETTER RELAYS

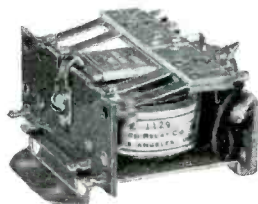

Countless Types and Modifications

You will find Leach Relays rendering service around the electrical world: in Industry, Electronics, Communications, Aviation, Transportation and Power.

During the past thirty years, Leach has faithfully maintained its policy of building quality equipment; and today, you'll find Leach delivers *quality in quantity*. The name LEACH stands for "better relays" and assures you of "better controls."

LEACH RELAY CO.

5915 AVALON BOULEVARD, LOS ANGELES 3, CALIF.

tiplane mountings, shear-type bonded-rubber vibration controls, are given in a 12-page booklet. Also included are tables showing sizes and specifications, and instructions on selection and installation.

(76)

Permanent Magnets. General Electric Co., Pittsfield, Mass., has issued a 36-page illustrated booklet on permanent magnets. General information as well as technical data on characteristics, design, properties and applications are given. Also included is a list of definitions of magnet terms.

(77)

Aluminum Wire. United States Rubber Co., Wire and Cable Dept., Rockefeller Center, New York, N. Y. A 25-page handbook points out that aluminum building wire is on a par with copper in regard to quality, has lower production costs, and is in more plentiful supply. Tables show relative weights of various size aluminum and copper conductors.

Wire and Cable Manual. Rome Cable Corp., Rome, N. Y. A pocket size manual including wire and cable technical tables, audio and radio frequency wire and cable data, and mathematical and conversion tables is available directly from the company at a cost of \$2.50.

Magnetic Tape Recorders. A bibliography of OTS reports on magnetic tape recorders may be obtained free of charge by writing direct to the Reference Service Section, Office of Technical Services, Department of Commerce, Washington 25, D. C.

Master Index. John F. Rider, Publisher, Inc., 404 Fourth Ave., New York 16, N. Y. has just issued a master index to cover information on all radio sets from 1919 through 1946. Printed in the same size as the well-known manuals, the paper-covered volume sells for \$1.50.

where Performance is Paramount... Specify...



- TIC PRECISION VARIABLE RESISTORS
- DYNAMIC NOISE SUPPRESSORS
- Z-ANGLE METER

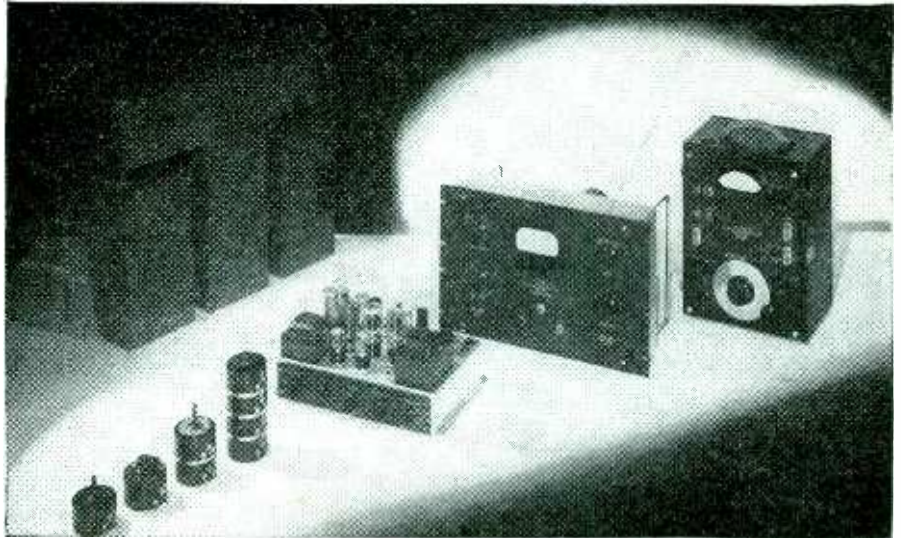

Left To Right: Type RV3 Precision Variable Resistor for use as a precision instrument component; Type RVL3 for the experimental laboratory; Two examples of ganging simplicity (Type RV3 Resistors); Type 210-A Laboratory Amplifier with Dynamic Noise Suppressor for radio-phonograph use; Type 910-A Dynamic Noise Suppressor, Broadcast station model; Z-Angle Meter for checking "match up" in any sound circuit.

PRECISION VARIABLE RESISTORS . . . Type RVL3 for experimental laboratories. Reading accuracy of $\pm 1\% \pm \frac{1}{2}$ dial division. Dial calibrated from 0 to 10, subdivided into 50 divisions. Type RV3 for use as a precision instrument component. Reliable and accurate. Ganging simplicity offers countless applications at audio and supersonic frequencies.

TIC resistors are available in 100 to 100,000 ohm range—have precious metal contacts, reliable rotor take-off assembly, adjustable stop and dust-proof construction.

DYNAMIC NOISE SUPPRESSORS . . . Eliminate needle scratch and bass rumble in musical records and transcriptions without appreciably altering musical quality. An electronic "gate" automatically varies audio amplifier band width in accordance with the frequency range being reproduced. Type 210-A is adaptable to home phonographs. Type 910-A is widely used in broadcast stations.

Z-ANGLE METER . . . For measuring Impedance and phase Angle versus Frequency of circuits, circuit elements or networks containing electrical or mechanical resonances. Also a laboratory instrument for measuring resistance, inductance, capacitance, storage coefficient and dissipation factor.

Write today for full information and specifications.

Engineering Representatives:

**Chicago: 1024 Superior Street,
Oak Park, Illinois.
Phone: Village 9245**

**Hollywood: 623 Guaranty Bldg.
Hollywood 28, California
Phone: HOLLYWOOD 5111**

See our exhibit, Booth 145 at the N.A.B. Show



TECHNOLOGY INSTRUMENT CORPORATION
1058 MAIN STREET
WALTHAM 54, MASS.

ALNICO

permanent

MAGNETS

- Specialists in the production of highest grade Alnico Magnets.
- Production and material rigidly inspected to assure highest uniform quality.
- Castings made to order from customer's blueprints or sketches.
- Information and suggestions supplied on request.

Manufacturers of High Coercive Magnetic Alloys

10001 ERWIN AVENUE
DETROIT 5, MICHIGAN

GENERAL



MAGNETIC CORPORATION

The Smartest 3¢ You Ever Invested!



Three pennies in postage will bring you the answer to real cost reductions in marking wires, leads, circuits, relays, parts, etc.

• As alert production, maintenance, and repair men everywhere have discovered, **QUIK-LABELS** do the job better, faster and cheaper than string tags, roll tapes, decals, stencils, metal tabs, etc.

You can't afford not to look at **QUIK-LABELS**... particularly when a 3c stamp will bring you **FREE SAMPLES*** by return mail. Clip that convenient coupon now. **W. H. BRADY COMPANY** — Identification Specialists — Milwaukee, Wisconsin.



W. H. BRADY COMPANY
240 W. Wells St.,
Milwaukee 3, Wis.

Please send me **FREE** samples of **QUIK-LABELS**, the modern time and money saving way to mark wires, leads, circuits, relays, parts, etc.

Name _____

Position _____

Please attach to your **BUSINESS** letterhead

It's

Legri S

for

RESISTORS

Half - One - Two Watt

- INSULATED
- ANY TOLERANCE
- WE CALIBRATE RESISTORS within 1 and 2% Tolerance.
- ANY QUANTITY
- ANY MAKE

Immediate Delivery!

WE SHIP THE SAME DAY YOUR ORDER IS RECEIVED

Inquire Today!

LEGRI S COMPANY, Inc.

ELECTRONIC PARTS AND COMPONENTS

846-850 Amsterdam Ave.
NEW YORK 25, N. Y.

AC 2-0018

Announcing

The 1st volume in the long-awaited
Massachusetts Institute of Technology
RADIATION LABORATORY SERIES

Bringing you

the engineering data you need to design RADAR SYSTEMS

Here is an important book which presents the general principles of the design of various radar systems. From the standpoint of the designer the book discusses the basic considerations which underlie and are particular to systems design. After a general approach to problems encountered, it takes up the leading design considerations for the important components that make up a radar set. Two new and important auxiliary techniques—moving target indications and the transmission of radar displays to a remote indicator by radio means—are fully treated. Detailed examples of actual systems are included. Anyone interested in the varied applications of radar will find this new volume of immense value as a basic, useful reference.

Just Published

RADAR SYSTEM ENGINEERING

Edited by Louis N. Ridenour, Editor-in-Chief, Radiation Laboratory Series; Associate Professor of Physics, University of Pennsylvania. 748 pages, 6x9, illustrated, \$7.50.

This is the first of twenty-eight volumes prepared principally by members of the Radiation Laboratory maintained during the war at the Massachusetts Institute of Technology under contract with the National Defense Research Committee of the Office of Scientific Research and Development. The Laboratory was the foremost U.S. research and development institution in the field of microwave radar. The accuracy of the material made available in these volumes is attested by their authoritative background.

Contents

- | | |
|---|--|
| 1. Introduction | 9. Antennas, Scanners, and Stabilization |
| 2. The Radar Equation | 10. The Magnetron and The Pulsar |
| 3. Properties of Radar Targets | 11. R-F Components |
| 4. Limitations of Pulse Radar | 12. The Receiving System—Radar Receivers |
| 5. C. W. Radar Systems | 13. The Receiving System—Indicators |
| 6. The Gathering and Presentation of Radar Data | 14. Prime Power Supplies for Radar |
| 7. The Employment of Radar Data | 15. Examples of Radar System Design |
| 8. Radar Beacons | 16. Moving-target Indication |
| | 17. Radar Relay |



See it
10 Days
FREE

McGraw-Hill Book Co., 330 W. 42nd St., N.Y. 18
Send me M.I.T. Radiation Lab., No. 1: Ridenour
—Radar System Engineering, for 10 days' examination on approval. In 10 days I will send \$7.50 plus few cents postage or return book postpaid. (Postage paid on cash orders.)

Name _____

Address _____

City and State _____

Company _____

Position _____ L-9-47

For Canadian price, write: McGraw-Hill Co. of Canada, Ltd., 12 Richmond St. E., Toronto 1

NEWS OF THE INDUSTRY

(continued from p 146)

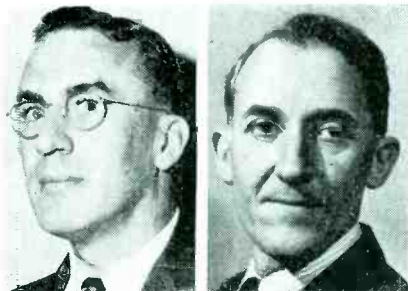

J. D. Colvin

A. B. Towne

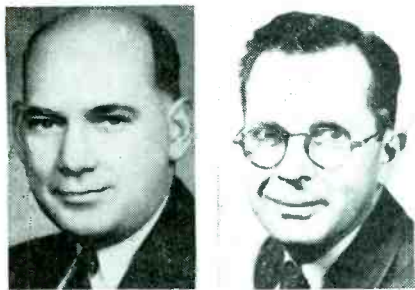

D. B. McKey

G. P. Adair

duced for small stations by G. Porter Houston, chief engineer of WCBM, Baltimore, Md., and for medium-size stations by Alfred E. Towne, director of engineering for KSFO in San Francisco, Calif.

Directional Antennas, Their Care and Maintenance, by Dixie B. McKey, consulting radio engineer, Washington, D. C.

Technical Regulation of Radio, by George P. Adair, radio engineering consultant, Washington, D. C.

FCC-Industry engineering roundtable: Commission representatives, headed by chief engineer George E. Sterling, will be: John A. Willoughby, assistant chief engineer; James E. Barr, chief of Standard Broadcast Division; Cyril M. Braum, chief of F-M Broadcast Division; Curtis B. Plummer, chief of Television Broadcast Division.

Also of engineeringwise interest at the convention will be the exhibit and demonstration of latest television, facsimile, f-m, and a-m broadcasting equipment.

FCC Licenses for Radar

PURCHASERS of surplus radar and other electronic devices capable of radio emissions must obtain appropriate station licenses before operating such equipment, according to an FCC warning. Section 301 of the Communications Act requires licensing of radar equipment, and Section 318 stipulates that radar stations may be operated only by persons licensed or authorized by the Commission.

Retailers of surplus equipment are urged to cooperate by attaching to apparatus a tag calling attention to the penalties involved in unauthorized operation. These tags may be obtained without charge from the Secretary, Federal Com-

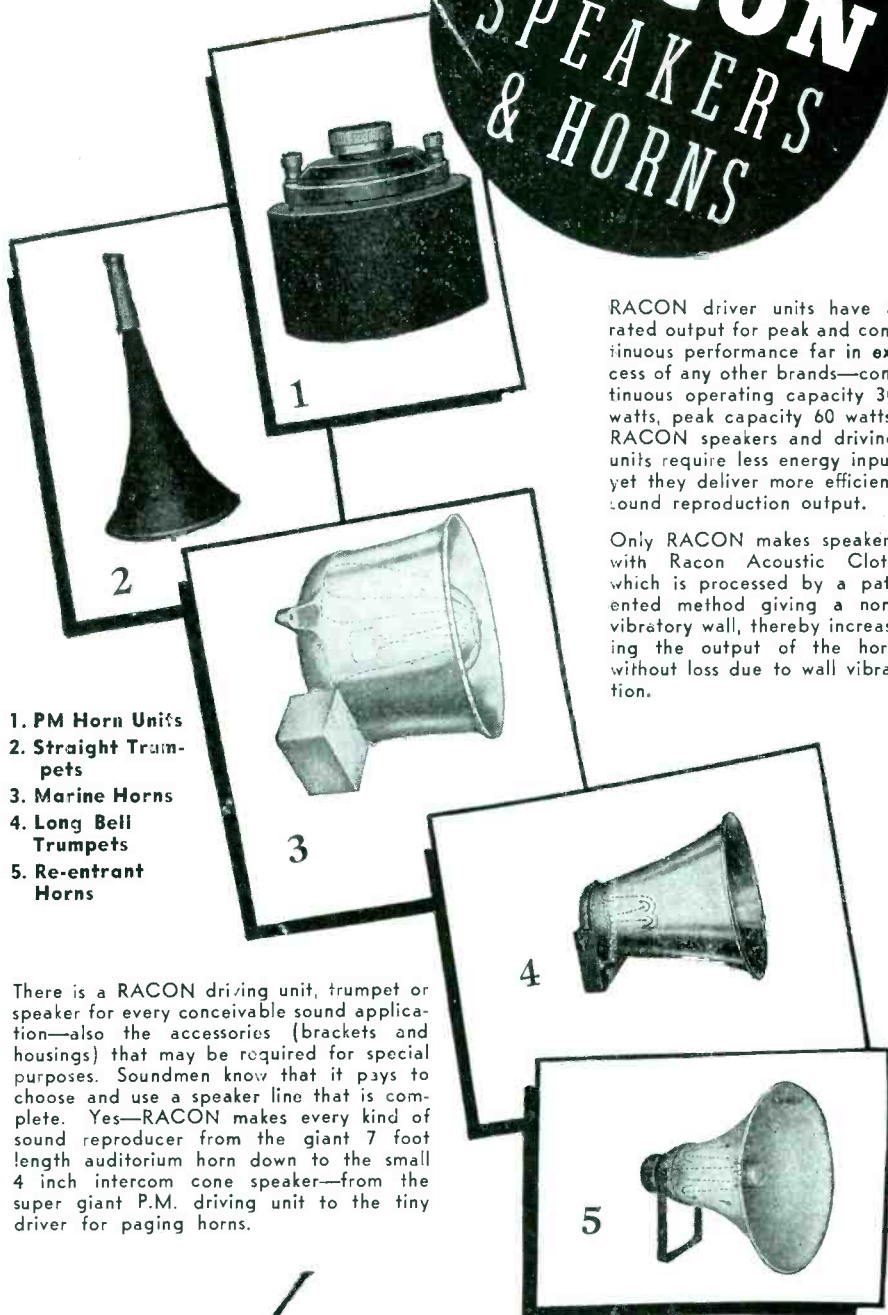

- 1. PM Horn Units
- 2. Straight Trumpets
- 3. Marine Horns
- 4. Long Bell Trumpets
- 5. Re-entrant Horns

There is a RACON driving unit, trumpet or speaker for every conceivable sound application—also the accessories (brackets and housings) that may be required for special purposes. Soundmen know that it pays to choose and use a speaker line that is complete. Yes—RACON makes every kind of sound reproducer from the giant 7 foot length auditorium horn down to the small 4 inch intercom cone speaker—from the super giant P.M. driving unit to the tiny driver for paging horns.

RACON driver units have a rated output for peak and continuous performance far in excess of any other brands—continuous operating capacity 30 watts, peak capacity 60 watts. RACON speakers and driving units require less energy input yet they deliver more efficient sound reproduction output.

Only RACON makes speakers with Racon Acoustic Cloth which is processed by a patented method giving a non-vibratory wall, thereby increasing the output of the horn without loss due to wall vibration.

SEND FOR OUR NEW FREE CATALOG TODAY!

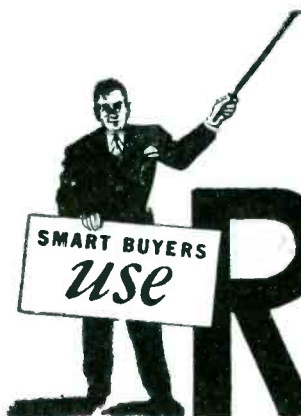

RACON

RACON ELEC. CO., INC., 52 E. 19 ST., NEW YORK, N. Y.

BUILDERS OF COMMUNICATIONS EQUIPMENT, MEASURING INSTRUMENTS FOR COMMERCIAL AND INDUSTRIAL USE, AND OTHER ELECTRONIC DEVICES—PRODUCTS WHERE PRECISION PERFORMANCE LARGELY DEPENDS UPON TIME AS A FACTOR OF CONTROL—KNOW THEY

can rely on

Cramer
DESIGN
QUALITY
ACCURACY



RUNNING TIME METERS

Synchronous motor driven. Register automatically and cumulatively total operating or idle time on circuits, machines, systems.



TIME DELAY RELAYS

Provide adjustable or fixed time delay between operation of a control circuit and subsequent opening or closing of a load circuit.



SYNCHRONOUS MOTORS

Permanent magnet type for applications requiring a constant speed at a given frequency. Small size. 30" ounce torque. Twenty-eight speeds from 60 rpm to 1/24 rph.

For a wide range of standard timers and controls... or special adaptations for specific applications... consult R. W. CRAMER CO., Box No. 3, Centerbrook, Conn.

Cramer
SPECIALISTS IN TIME
AS A FACTOR OF
CONTROL

INTERVAL • DELAY • CYCLE • IMPULSE • PERCENTAGE

munications Commission, Washington 25, D. C. Information on licenses for experimental radar operation may be secured from the same address.

Instrument Conference

ADVANCE registrations for the Second National Instrument Conference, to be held at the Stevens Hotel in Chicago Sept. 8-12, indicate that attendance will exceed 7,500. General chairman is A. F. Sperry, president of Panellit, Inc., Chicago. The technical program for the four days is as follows:

Sept. 9—9:00 a.m.: Quality Control—A Management Tool for Process Industries, by W. E. Jones of Management Controls, Desplaines, Ill.

Precision of Measurements, by F. Trowbridge of Sentinel Radio Co., Evanston, Ill.

9:00 a.m. (concurrent session): The Fundamentals of Radioactivity, by G. J. Overbeck of Northwestern University.

The Application of Radioactive Indicators to Industrial Problems, by R. D. Evans of MIT.

Instruments for the Measurement of Tracer Radiation, by F. R. Shonka of Argonne National Laboratory, Chicago.

2:00 p.m.: Applications of Viscosity Measurements in Petroleum Refining Operations, by D. J. Pompeo of Shell Development Co., Emeryville, Calif.

Polarographic Analysis—Principles, Techniques, and Applications, by L. D. Wilson of Corn Products Refining Co.

Adaptation of the General Electric Spectrophotometer for Special Measurements, by R. H. Kienle and E. I. Stearns of American Cyanamid Co.

Some Problems of Application of Conductivity Equipment, by A. L. Chaplin of Johns Hopkins University.

8:00 p.m.: Automatic control and servo mechanism symposium.

Sept. 10—9:00 a.m.: Demonstration of Automatic Control Principles, by G. F. Akins of Eastman Kodak Co., assisted by John H. Kowalski.

2:00 p.m.: Instrument Installation and Maintenance Methods and Practices in a Modern Oil Refinery, by G. A. Larsen of Texas Co.

Instrumentation in Turbine Testing, by A. B. Sisson of Public Service Co. of Northern Illinois.

Organization and Operation of a Calibration Laboratory, by H. N. Hayward of University of Illinois.

Sept. 11—9:00 a.m.: Instrumentation of an Acetic Acid Concentration Process, by J. E. Voytilla of du Pont.

Sea Water Bromine Process Chemical Control System, by P. Hart of Dow Chemical Co.

2:00 p.m.: Dew Point Recorder, by B. Suomi of University of Chicago.

Instrumentation for Aeronautical Research, by Edward Bloom of Cornell Research Foundation, Inc.

Design and Application of A New Metals Comparator, by D. E. Bovey of G-E.

Sept. 12—9:00 a.m.: Basic Design and Field Performance of the Control and Measurement Instrumentation of an Alkylation Unit, by H. F. Moore and G. W. Gross of Standard Oil.

Application of Conventional Industrial Instruments to Power Plant Control, by W. H. Portney of Humble Oil Co.

Western IRE Conference

OPENING at the Palace Hotel, San Francisco on Sept. 24, the IRE conference held in conjunction with the West Coast Electronic Manufacturers' Association will extend through Sept. 26 and include six technical

MICRODIMENSIONAL
WIRE & RIBBON
FOR VACUUM TUBES

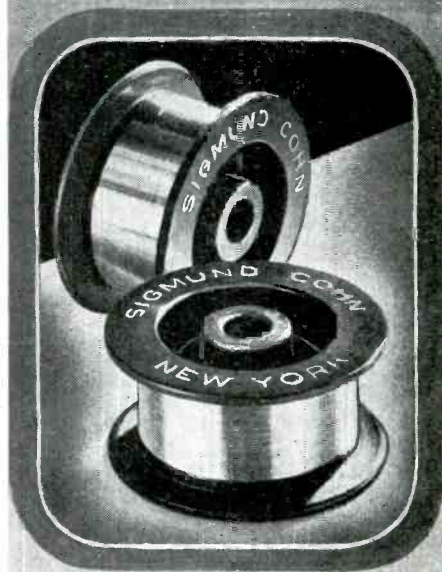

Wires drawn to .0004" diameter.

Ribbon rolled to .0001" thickness.

Special Alloys for individual requirements.

WRITE for list of stock alloys.

SIGMUND COHN & CO
44 GOLD ST. NEW YORK



ALLENUT

The New

internal wrenching, self-locking nut by ALLEN



This new internal-wrenching nut **HOLDS** with a weld-like grip, — *self-locking* in non-hardened metals. Knurled flutes are drawn down into counterbored hole as the screw is tightened in the nut. Yet easily removed without damage to nut or containing parts by backing off on screw and tapping screw on head.

Using *ALLENUTS* with Allen Socket Head Cap Screws, the positive *internal* wrenching action of Allen Hex Keys drives fast, firm set-ups in the harder metals. 12-point (double-hex) Allenut socket gives 30° of wrenching swing — as compared with a normal 60° — to speed up assembly in cramped quarters.

The *ALLENUT* sets up *flush* to achieve streamlined surfaces. It facilitates more compact designs with resulting economies in space, weight and material. Adds immensely to the finished appearance of any job . . . Precision-made of special-alloy steel to Allen standards; threads tapped to a Class 3 fit.

Ask your local Industrial Distributor for samples for test applications. Available only through authorized ALLEN Distributors.

THE ALLEN MFG. COMPANY
HARTFORD 1, CONNECTICUT, U. S. A.

Cetron

MERCURY and GASFILLED
GRID CONTROL RECTIFIERS

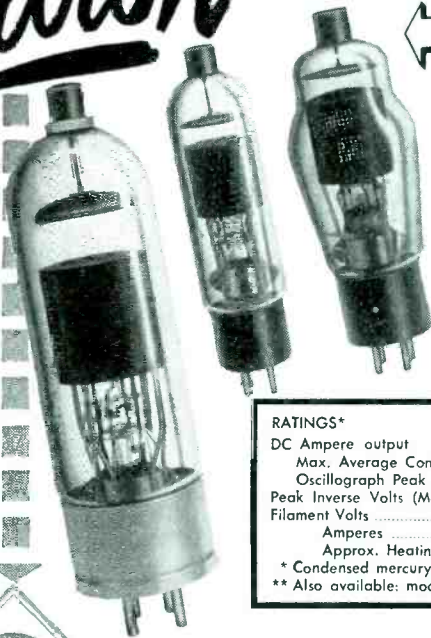

- ← LONG LIFE
- ← HIGH EFFICIENCY
- ← QUICK START

These inexpensive rectifier tubes are designed for industrial applications such as welding control, motor control, etc., at ambient temperature limits of approximately -40° to +80° C.

RATINGS*	CE-311**	CE-320	CE-322
DC Ampere output			
Max. Average Continuous.....	1.5	2.5	6.4
Oscillograph Peak.....	6.0	30.0	80.0
Peak Inverse Volts (Max. Inst.).....	1000	1250	1500
Filament Volts.....	2.5	2.5	2.5
Amperes.....	6±1	9±2	20±3
Approx. Heating Time (in sec.)	15	30	45

* Condensed mercury temperature 40—70° C.
** Also available: modified types CE-323A and CE-393A.



For technical data and special information write to
CONTINENTAL ELECTRIC CO.
Geneva, Illinois

BAKELITE SHEETS, RODS AND TUBES

On special mill shipments we can give prompt delivery. Also complete fabrication service backed by over 20 years of experience.

**ELECTRICAL
INSULATION CO., INC.**

12 Vestry St., New York 13, N. Y.

SUSTAINED ACCURACY

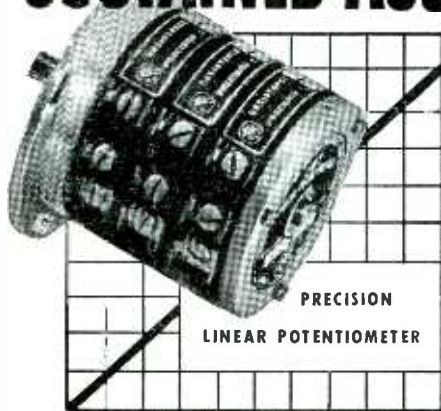

OVER
1,000,000
CYCLES
AT
30 rpm

(Single units or ganged as illustrated)

NEW! Fairchild's new Linear single-turn Potentiometers are small precision instruments—that out-perform conventional potentiometers. Sustained accuracy and long service are assured by Fairchild construction that includes contacts composed of gold, platinum and silver alloys. Performance includes a guaranteed linearity accurate to 0.15% (2" size); 0.1% (3" size) . . . less than one ounce-inch torque and 4 or 5 watt power dissipation . . . 100 to 100,000 ohm resistance range . . . single or ganged flexibility . . . 351° and 355° angles of electrical rotation. Available in 2" and 3" sizes. Engineered for quantity production. For further information address: Dept. 'E', 88-06 Van Wyck Boulevard, Jamaica 1, New York.



Fairchild CAMERA
AND INSTRUMENT CORPORATION

PYROFERRIC

DOUBLES ITS SPACE,
EQUIPMENT AND
CAPACITY TO MEET
THE INCREASING
DEMAND FOR ITS

IRON CORES

WHICH FOR 14 YEARS
HAVE SET STANDARDS
FOR COMPARISON IN
POWDERED METALLURGY

PYROFERRIC manufactures a full line of standard sized Powdered Iron Screw-Type Cores of varying lengths, with standard threads, as well as a complete line of powdered iron cores, with and without inserts.

For Powdered Iron Cores to meet your specifications, address your inquiry to

PYROFERRIC Co.

621 East 216 Street, New York City 67

sessions. Beginning Sept. 26, the WCEMA will offer closed sessions of exhibits at the Whitcomb Hotel for two days, then open the hall to the general public on Sunday Sept. 28. Papers scheduled for the IRE session include the following:

Technical Problems of Military Radio Communications of the Future, by John Hessel of Signal Corps Engineering Labs.

Some Applications of Electronics to Underwater Ordnance, by Ralph D. Bennett of Naval Ordnance Lab.

Some Experimental Determinations of Mutual Impedance of Antennas, by F. R. Abbott of U. S. Navy Electronics Lab.

A New Pulse-Time Telemetering System, by J. N. Davis of Sylvania Electric.

Microwaves in Ordnance Work, by F. G. Suffield of Allison Associates.

Telemetering Guided Missile Performance, by James C. Coe of U. S. Naval Air Missile Test Center.

A 50,000-Watt FM Transmitter for 100.5 Mc, by Leigh Norton of Eitel-McCullough.

Susceptibility of F-M Receivers to Interfering Signals, by D. E. Foster of Hazeltine Research, Inc. of California.

Frequency Modulation Detectors, by S. W. Seeley of RCA Industry Service Lab. Limiters and Discriminators in F-M Receivers, by W. G. Tuller of MIT.

A VHF Bridge for Impedance Measurements, by Robert Soderman of General Radio.

A Pulse-Counter Type F-M Station Monitor, by David Packard and Norman Schrock of Hewlett-Packard.

Supersonic Flaw Detection, by Donald Erdman of Triplett and Barton.

Electronic Gage Methods and Apparatus, by R. L. Sink of Consolidated Engineering.

Equivalent Networks for Wave-Guide Problems, by J. R. Whinnery of U. of Calif.

The New York-Boston Radio Relay, by J. W. McRae of Bell Labs.

High-Quality Loudspeakers, by J. K. Hilliard of Altec Lansing.

A New Solution of the Antenna Problem, by C. Lanczos of Boeing Aircraft.

The Proton Linear Accelerator, by L. W. Alvarez of U. of Calif.

The Electron Linear Accelerator, by W. W. Hansen of Stanford University.

Oscillation and Gain Properties in New Types of Traveling-Wave Tubes, by L. M. Field of Stanford.

Resonator Design, by W. W. Salisbury of Collins Radio.

Radio-Wave Propagation in the F-M Broadcast Band, by K. A. Norton of National Bureau of Standards.

A Five-Kw Television Transmitter, by J. E. Keister, J. W. Downie, H. B. Saucher, and L. M. Ewing of G-E.

A Modern Television Transmitter, by C. D. Kentner of RCA Labs.

Receiving Antennas for F-M and Television.

Airline Inaugurates Radiograms

PASSENGERS on Pan American World Airways new round-the-world route will be able to send radiograms to any part of the United States. Use of Radiomarine's powerful radiotelegraph station at Chatham, Mass. as the key station for this service has been approved by the FCC. Other RCA stations in Manila, Honolulu, and Bolinas, Calif. will assist in handling correspondence if needed.

The inaugural flight of the clipper America on this route marks the first transoceanic journey in which airborne radio communication facilities were available to pas-

Now -- a clear engineering introduction to **KLYSTRON TUBES**

- theory
- operation
- construction
- performance
- application



This authoritative book provides electronic engineers, radio technicians, and others, with a sound working knowledge of both the operating principles and practical applications of klystron tubes. It supplies the bulk of the answers to your questions concerning methods of construction—performance characteristics—procedures for testing, etc.—and shows how these tubes may be used as oscillators, amplifiers, frequency multipliers, and detectors or mixers.

Just Published!

KLYSTRON TUBES

by **A. E. Harrison**

Former Klystron Applications Engineer, Sperry Gyroscope Co.

271 pages, 6 x 9.

139 illustrations, \$3.50

Here is a clear explanation of how the process of velocity modulation enables the electronics engineer to transform electrical energy into radio frequency energy—and how this principle is applied to klystrons. Among the helpful features of the book are useful design charts, and much valuable new data on multiple resonator tubes and modulation.

14 helpful chapters, including:

- | | |
|--------------------------|-----------------------|
| Klystron Construction | Microwave Measurement |
| Klystron Amplifiers | Technique |
| Modulation of Klystrons | Klystron Frequency |
| Electron-Bunching Theory | Multipliers |
| Klystron Operation | Cavity Resonators |
| Klystron Power Supplies | Reflex Oscillators |

SEE IT 10 DAYS — MAIL COUPON

McGraw-Hill Book Co.,
330 W. 42nd St., New York 18
Send me Harrison's Klystron Tubes for 10 days' examination on approval. In 10 days I will send \$3.50, plus few cents postage, or return book postpaid. (Postage paid on cash orders—same return privilege.)

Name
Address
City and State
Company
Position J-9-47

For Canadian price write:
McGraw-Hill Book Co., of Canada, Ltd.,
12 Richmond Street E., Toronto 1

- **RUGGED**
- **DEPENDABLE**
- **ACCURATE**

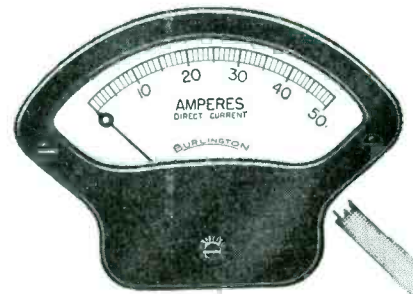

PANEL INSTRUMENTS

For utmost reliability—specify and depend upon Burlington Panel Instruments. They are designed, engineered and built to give satisfactory service even under most severe applications—and are fully guaranteed for one year against defects in material or workmanship.

Write today for full details.

BURLINGTON INSTRUMENT COMPANY
122 FOURTH STREET BURLINGTON, IOWA

RH-7B

RH-7B can be supplied with 3-15 mc fundamental output frequencies, or 15-75 mc harmonic mode output frequencies.

By doubling or tripling in the plate circuit of the crystal stage, sufficient output can be obtained to excite the following stage in a transmitter to frequencies as high as 200 mc.

This versatile crystal unit can also be used as a local oscillator in a receiver at frequencies up to 200 mc.

Capacity between pins in the harmonic mode unit is less than 4 mmfd. As low as ±.005% maximum frequency drift over a temperature range of -55°C to +90°C.

Write for Bulletin RHC-3

REEVES-HOFFMAN CORPORATION

SALES OFFICE: 215 EAST 91 STREET, NEW YORK 28, N. Y.
PLANT: 321 CHERRY STREET, CARLISLE, PA.



ATLAS

*The Seal of
Sound Supremacy*



REENTRANT PROJECTORS



DRIVER UNITS



BOOSTER UNITS



RADIAL PROJECTORS



Baffles
Enclosures
Desk Stands
Speaker
Stands
Adaptors
Wall Boxes
Boom Stands

Write for illustrated catalog sheets

ATLAS SOUND

CORPORATION

1449 39th Str., Brooklyn 18, N. Y.

sengers of an American plane. Overall message rates for the service are similar to those applying to ships at sea.

RMA Section Chairmen

SECTION chairmen for the Parts Division of RMA during 1947-48 fiscal year have been selected by division chairman J. J. Kahn, president of Standard Transformer Corp., Chicago, as follows:

Coil Section: Edwin I. Guthman, Edwin I. Guthman & Company, Inc., Chicago, Ill.
Fixed Capacitor Section: W. Myron Owen, Aerovox Corporation, New Bedford, Mass.
Fixed Resistor Section: J. Hall Stackpole, Stackpole Carbon Company, St. Marys, Pa.
Instrument & Test Equipment Section: R. L. Triplett, The Triplett Electrical Instrument Co., Bluffton, Ohio.

Insulations Section: John W. Appar, Irvington Varnish & Insulator Co., Irvington, N. J.

Metal Stampings and Metal Specialties Section: S. L. Gabel, Superior Tube Company, Norristown, Pa.

Phonograph Cartridges and Pickups Section: George B. Fraser, The Astatic Corporation, Connecticut, Ohio.

Plastics and Molded Parts Section: John J. Bachner, Chicago Molded Products Corporation, Chicago, Ill.

Record Changer and Phono-Motor Section: Allan W. Fritzsche, The General Industries Company, Elyria, Ohio

Socket Section: Frank Holmstrom, Hugh H. Eby, Inc., Philadelphia, Pa.

Speaker Section: Laurence A. King, The Rola Company, Inc., Cleveland, O.

Speaker Parts Section: A. D. Plamondon, Jr., The Indiana Steel Products Company, Chicago, Ill.

Special Products Section: William R. MacLeod, King Laboratories, Inc., Syracuse, N. Y.

Switch Section: William S. Parsons, Centralab, Milwaukee, Wisc.

Transformer Section: R. A. Hoagland, Jefferson Electric Company, Bellwood, Ill.

Variable Condenser Section: G. F. Behringer, The American Steel Package Co., Defiance, O.

Variable Resistor Section: D. S. W. Kelly, Allen-Bradley Company, Milwaukee, Wisc.

Vibrator Section: Ray F. Sparrow, P. R. Mallory & Co., Inc., Indianapolis, Ind.

Wire Section: R. G. Zender, Lenz Electric Mfg. Co., Chicago, Ill.

Wire Wound Resistor Section: D. T. Siegel, Ohmite Manufacturing Company, Chicago, Ill.

Chairmen of the Transmitter Division, announced by division chairman S. P. Taylor, distributor sales manager of Western Electric Co., New York, are:

Airation Section: H. M. Hucke, RCA Victor Division of RCA, Camden, N. J.

Broadcast Transmitter Section: C. W. Miller, Industrial Electronic Division, Westinghouse Electric Corp., Baltimore, Md.

General Communications Section: Natale Gada, General Electric Company, Syracuse, N. Y.

Marine Section: C. E. Maass, Western Electric Company, New York, N. Y.

Transmitter Tube Section: A. Frankel, Lamp Division, Westinghouse Electric Corp., Bloomfield, N. J.

Status of Facsimile

AT THE PRESENT time, facsimile broadcasting is on an experimental basis pending the formulation of



**Power
Resistor
DECADE BOX**

★ Here's a "must" for every well-equipped lab, plant, school, service shop, ship, etc. The unique Clarostat Power Resistor Decade Box solves resistance problems under actual working conditions. No calculations. No guesswork. No extensive experimentation. Instead, just insert in actual circuit, adjust decade knobs until best results are attained, and then read the correct resistance value right off the dials!

Covers resistance range of 1 ohm to 999,999 ohms.

Each decade dissipates up to 225 watts. Greenohm (wire-wound cement-coated power resistors) used throughout. Glass-insulated wiring.

Six decade switches on sloping panel. Direct-reading in ohms. Maximum current per decade: 5, 1.5, .5, .15, .05 and .005 amp.

Frosted-gray metal case. Etched black-and-aluminum panel. Dual binding post terminals for left-and right-hand duty.

Grille at bottom and louvers at side for adequate ventilation.

13" long; 8½" deep; 5¾" high. Weight, 11 lbs.

★ Write for Literature . . .

Bulletin No. 114 describes and illustrates the Clarostat Power Resistor Decade Box. Write for this literature. Your local Clarostat jobber can show you this "must" equipment.



CLAROSTAT MFG. CO., Inc. - 285-7 N. 6th St., Brooklyn, N. Y.

Specify
MYCALEX
LOW LOSS INSULATION

Where high mechanical and electrical specifications must be met.

For Complete Catalog and Specifying information on MYCALEX 400, K, & 410 refer to pages 84-85 in the 1947 Mid-June

BUYERS' GUIDE ISSUE
OF ELECTRONICS.

27 years of leadership in solving the most exacting high frequency insulating problems.

MYCALEX CORPORATION OF AMERICA

"Owners of 'MYCALEX' Patents"

Plant and General Offices: Clifton, N. J.
Executive Offices: 30 Rockefeller Plaza
New York 20, N. Y.

JONES 500 SERIES
PLUGS and SOCKETS
(Heavy Duty)

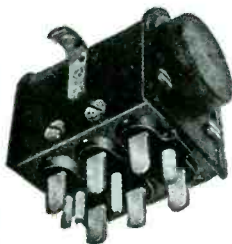

P-506-CE

Designed for 5000 Volts and 25 amperes per contact. Socket Contacts of phosphor bronze, knife-switch type, silver plated. Plug Contacts are of hard brass, silver plated. Made in 2, 4, 6, 8, 10 and 12 Contacts.



S-506-DB

All Plugs and Sockets are Polarized. Long leakage path from Terminal to Terminal and Terminal to ground. Caps and Brackets

are of steel, parkerized. Plug and Socket blocks interchangeable in Caps and Brackets. This series is designed for heavy duty electrical work and will withstand severest type of service.

Write for Bulletin No. 500 describing this line of Heavy Duty Plugs and Sockets.

HOWARD B. JONES DIVISION
CINCH MFG. CORP.
2460 W. GEORGE ST. CHICAGO 18

For Faster Soldering **WELLER**
SOLDERING GUN

5-SECOND HEATING
Ready to solder in 5 seconds.

LESS TIP RETINNING
Heats only when needed.

FAST COOLING
Ideal for service calls.

100 Watts
115 Volts
60 Cycles

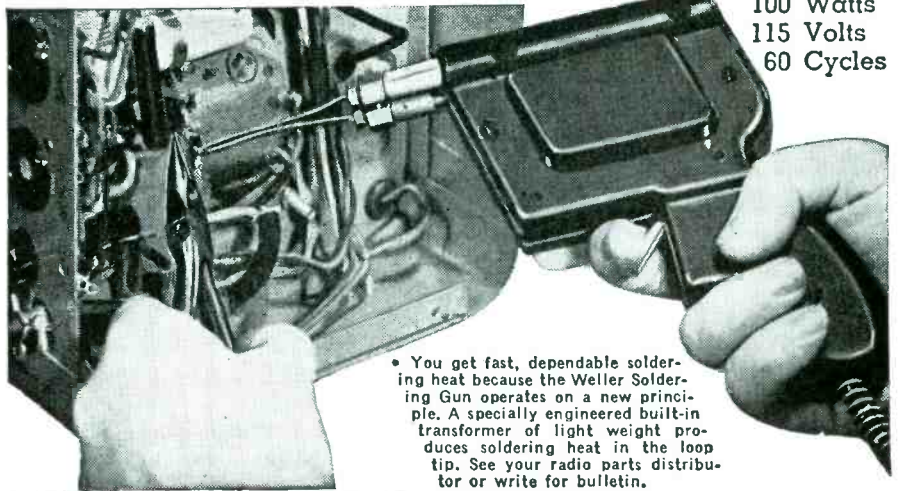

• You get fast, dependable soldering heat because the Weller Soldering Gun operates on a new principle. A specially engineered built-in transformer of light weight produces soldering heat in the loop tip. See your radio parts distributor or write for bulletin.

WELLER MFG. CO. 806 Packer St., Easton, Pa.

In Canada: Atlas Radio Corp., Ltd., 560 King St., N. W., Toronto, Ont.
Export Dept.: 25 Warren St., New York 7, N. Y.

TODAY'S
SCHOOLS...

must train for TOMORROW — a challenge intensified by the accelerating pace of scientific and engineering advance.

Specially designed to meet the needs of modern education, is the NEW...



TYPE S-14

STUDENT'S OSCILLOGRAPH

An Essential part of the modern college laboratory:

- Accuracy, for the critical researcher
- Simplicity, for the undergraduate student
- 6 to 12 channels, precision components

WRITE FOR
TECHNICAL BULLETIN
SP-183A

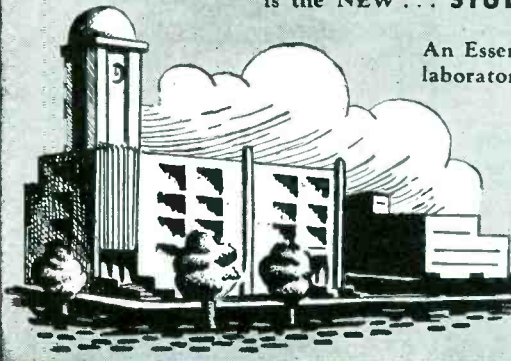

Hathaway
INSTRUMENT COMPANY
1315 SO. CLARKSON STREET • DENVER 10, COLORADO

"Synkote"*

THERMOPLASTIC INSULATED RADIO HOOK-UP WIRE

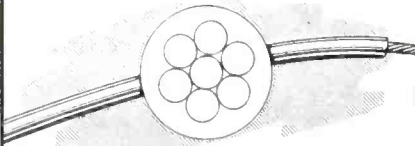

Type SRIR

Approved by the Army-Navy Electronics Standards Bureau (under Spec. JAN-C-76) for Radio Hook-up use where the voltage does not exceed 1,000 V. Sizes: 24 Solid to 6 Stranded.

Recommended for communications and industrial electronic control applications, this wire has proved to be superior to push-back and rubber insulated types because the Synkote insulation is almost totally impervious to water, oils, acids, alkalis, sunlight, cold, and fungus growths. It is vermin-proof, unusually resistant to abrasion, flexing, and tearing, and will not support combustion. In addition, it has extremely high dielectric breakdown strength and low dielectric leakage. In tests performed by the Bureau of Ships, TYPE SRIR did not break down under 12,000 V.

To cut out interfering fields, it can be shielded to any specifications with a braid of tinned or bare copper, woven (loose or tight) to any specified degree of coverage. Gauge of shielding strands varies according to individual requirements.

Other, standard, approved, Synkote Radio Hook-up Wires: Types SRHV, WL, and (Underwriters' Approved) TF, TFF, and Appliance Wiring Material are available in both small and large quantities — shielded, if desired, to any specifications.

Many other types of Hook-up Wire, to meet special requirements, can be manufactured on short notice — in practically any quantity. For complete information, consult our Engineering Department.

Synkote Antenna Wire, and Two-conductor Parallel Cord (with solid, unbreakable, molded plug) are also available.

All Synkote wire has unusually tough, practically age-proof insulation.

*Reg. U. S. Pat. Off.

PLASTOID Corporation



SALES and EXECUTIVE OFFICES:
19 WEST 44th STREET
NEW YORK 18, N. Y.
Factory: Hamburg, N. J.

NEWS OF THE INDUSTRY (continued)

rules and standards. Several f-m stations have from time to time been authorized to experiment with facsimile during hours not devoted to regular broadcasting, and these demonstrations have attracted considerable attention.

Since facsimile transmitters and receivers have a lock-and-key relationship, as in television, transmission standards are required so that any facsimile receiver will operate from any facsimile station in its area.

The Radio Technical Planning Board recently submitted proposed transmission standards to the Federal Communications Commission for consideration. Since there has been a difference of opinion in the development of the proposed standards, however, as to whether both 8.2 and 4.1-inch scanning lines should be provided at the same line rate of 105 lines per inch, and since there has been a limited amount of experimental operation and demonstrations to indicate public preference, the Commission has requested that further operation and comparisons be conducted. Upon the completion of such tests, it is believed that standards may be adopted promptly.

Other facsimile activity includes a facsimile news service for airplane passengers, which has been tested in flight. Radioed press dispatches were printed on an airliner in four columns at the rate of 500 words a minute. Operations by a New York bank were aided through rapid transmission of reproductions of checks and other documents from the bank's downtown central signature file to its uptown headquarters in 57 seconds. By using microwave transmission, facsimile has been relayed from Boston to New York. The Army Air Forces is installing a facsimile system to transmit weather maps over the nation for the information of pilots.

BUSINESS NEWS

HOUSTON CORP., Los Angeles, Cal., received a \$1,000,000 Navy contract for the manufacture of 100 new airborne radar sets to be used in all four-engine transport planes of the

BROWNING LABORATORIES

Precision Instruments
for Electronics and
Radio Research and
Testing



Versatile, Precision OSCILLOSCOPE MODEL 01-15

This is a highly flexible instrument particularly adaptable for production testing or research work in television, radar, facsimile work, and radio-frequency equipment.

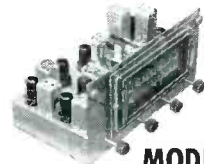

MODEL RJ-12 FM-AM TUNER

An easy-to-install highly-sensitive tuner that provides distortion-free reception on FM and quality reception on AM. Tuning eye shows correct tuning. One antenna serves both FM and AM. Many other features. Armstrong circuit.

WWV FREQUENCY CALIBRATOR

Full, accurate use of station WWV, the world's finest primary frequency and time standard, is obtained from the Browning Model RH-10 Standard Frequency Calibrator.

WRITE FOR LITERATURE

OTHER EQUIPMENT manufactured by Browning Laboratories includes an accurate frequency meter and ECO Model MJ-9, for operating in the Ham bands, and a frequency meter (Model S-4) especially designed for checking mobile transmitters.



BROWNING
LABORATORIES, INC.
WINCHESTER, MASS.

**EISLER
ELECTRICAL & ELECTRONIC
EQUIPMENT
ELECTRONIC TUBE EQUIPMENT**

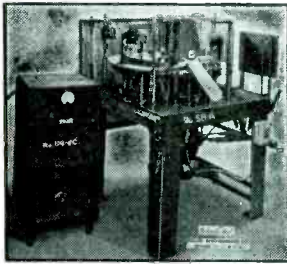

**24 HEAD
RADIO TUBE
EXHAUSTING
MACHINE**

We Make Complete Equipment For The Manufacture Of Incandescent Lamps Radio and Electronic Tubes.

TRANSFORMERS OF ALL TYPES

For LIGHTING POWER FURNACES PHASE CHANGING DISTRIBUTION ETC.

Air, Oil, or Water Cooled



Sizes 1/4 To 250 KVA
SPOT WELDERS
OF ALL TYPES
FOR ALL PURPOSES
SIZES 1/4 to 250 KVA

Butt Welders - Gun Welders
Arc Welders
Neon Sign Units
Fluorescent Tube
Manufacturing Equipment



**CHAS. EISLER
EISLER ENGINEERING CO., INC.**
751 So. 13th St. (Near Avon Ave.), Newark 3, N. J.

**TWO NEW EASTERN PUMPS
FOR NONLUBRICATING LIQUIDS**

The recently announced VW line of positive pressure vane type pumps for nonlubricating liquids such as water is now supplemented by two new models—



VW-5 and VW-10. The basic characteristics of construction that were built into the initial model of the series, VW-1 are incorporated in the new models. Composition bearings that require no lubrication beyond that furnished by the liquid being pumped eliminate all possibility of contamination. Vanes of the same material as the bearings are held in contact with the pump chamber by their special design and radii. In this way volumetric efficiency is maintained

without centrifugal force. A built-in bypass is furnished for outlet pressure regulation. Shaft seal is accomplished by a mechanical rotary seal.

Specifications:

Model	Motor H.P.	Weight Lbs.	Length	Width	Height
VW-5A	1/8	26	12 7/16"	5 1/2"	5 3/4"
VW-5B	1/4	32	14 9/32"	6 9/16"	6 21/32"
VW-10A	1/4	34	15 1/8"	6 5/16"	6 21/32"
VW-10B	1/8	34	15 1/8"	6 9/16"	6 21/32"
VW-10C	1/2	52	17"	7 1/2"	7 7/8"

Performance: See chart.

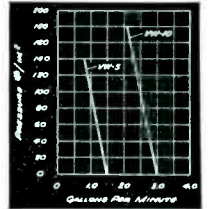

Eastern Industries has engineered more than 300 different pumps for industrial applications. If you have a pumping problem where small size, light weight and high performance are factors, write us. Ask for Bulletin 113 and address all inquiries to Eastern Industries, Incorporated. 296 Elm St., New Haven, Conn.

EASTERN INDUSTRIES
Incorporated
NEW HAVEN, CONNECTICUT
Norwalk, Connecticut Newton, Massachusetts

**Flexible
SHAFTS**

FLEXIBLE SHAFTS

that carry power around any corner have many new uses in peace-time developments. Faithful, dependable power drives or remote control in airplanes, automobiles, radio, and many other commercial products.

Shafts made to your specifications. Our engineering department will work out your particular power problem without obligation.

Write today for Manual D

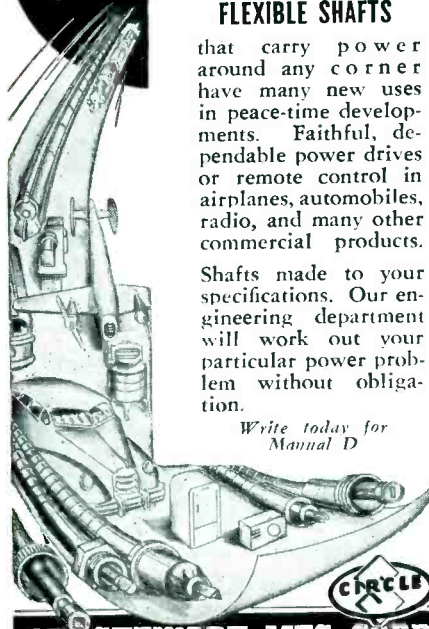

F. W. STEWART MFG. CORP.
4311-13 RAVENSWOOD AVE.
CHICAGO 13, ILL.
WEST COAST BRANCH:
431 Venice Blvd.; Los Angeles 15, Cal.

new

CONCORD

Radio

Catalog

**INDUSTRIAL ELECTRONIC
and TEST EQUIPMENT • RADIO
PARTS • SETS • AMPLIFIERS**

This is it—the new 1947 Concord Catalog—a vast, complete selection of everything in Radio and Electronics—thousands of items available for IMMEDIATE SHIPMENT from CHICAGO or ATLANTA—hundreds now available for the first time—featuring new, latest 1947 prices. See new LOWER prices on RADIO SETS, PHONO-RADIOS, RECORD CHANGERS, RECORD PLAYERS, PORTABLES, AMPLIFIERS, COMPLETE SOUND SYSTEMS, TESTERS. See latest listings of standard, dependable lines of radio parts and equipment—tubes, condensers, transformers, relays, etc. Mail coupon for FREE COPY—NOW!

TIME PAYMENTS: Write us for details of time payment plan on Communications Receivers, Amplifiers, Test Equipment, Radios, Phono-Radios, etc.



free

Mail COUPON TODAY!

Concord Radio Corporation, Dept. G-97
901 W. Jackson Blvd., Chicago 7, Ill.
Yes, rush FREE COPY of the comprehensive new Concord Radio Catalog.

Name:
Address:
City: State:

CONCORD
RADIO CORPORATION
LAFAYETTE RADIO CORPORATION
CHICAGO 7, ILL. ATLANTA 3, GA.
901 W. Jackson Blvd. 265 Peachtree St.

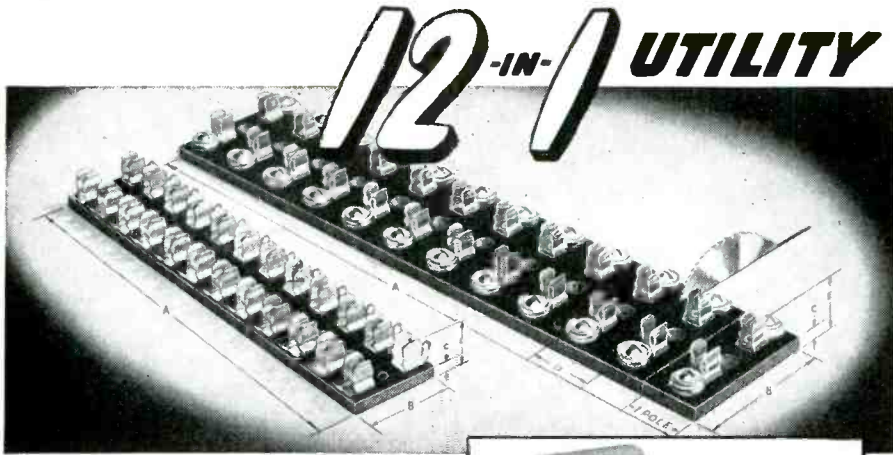

12-IN-1 UTILITY

New 12-pole Littelfuse unit saws into single or multiple mountings.

Be instantly ready to supply any length open fuse-mounting panel; also simplify your parts inventory. Stock all five available styles of this new Littelfuse 12-pole unit. Saw them to 1, 2, 3, 4 or more pole-lengths in your own plant as needed; or order them cut to your specifications.

Solder-terminal types are available in 3 and 8 AG capacities. Terminals are integral parts of clips.

Screw-terminal types available in 3, 4 and 5 AG capacities. Send for Littelfuse Catalog No. 9 today.



CAN COVERED MOUNTINGS FOR 3 AG FUSES

Fatigue-resistant nickel plated phosphor bronze clips—mounted on black Bakelite base. Solder terminals extend through base. Available in single and double pole and combination types.

3 AG "SLO-BLO" LITTELFUSES

High time lag withstands heavy surges—yet is quick on shorts. Designed for use with magnets, solenoids, etc.; and for intermittent duty circuits with heavy starting currents. Anti-fatigue construction.



Naval Air Transport Service. The new APS-42 radar, weighing approximately 150 lb, uses a 5-inch ppi screen to give the pilot a radar map of 220 degrees of terrain ahead of the plane if the radar scanner is mounted in the nose, or a complete 360-degree map if the scanner is placed under the fuselage.

AIR KING PRODUCTS Co., INC., Brooklyn, N. Y., has acquired an additional plant, occupying an en-

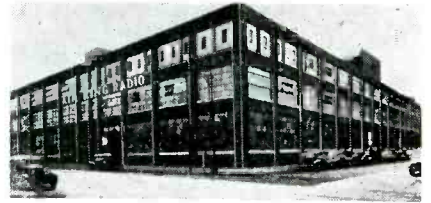

New Air King plant

tire city block at 170 53rd St., for straight-line manufacture of radio sets.

RAY-O-VAC Co., Madison, Wisconsin, announces formation of a subsidiary, the Specialty Battery Co., which will manufacture dry batteries for highly specialized purposes in the electronics field.

CASE SCHOOL OF APPLIED SCIENCE, Cleveland, Ohio, recently changed its name to Case Institute of Technology.

NORTH AMERICAN PHILIPS Co., INC., New York City, has acquired a new 2½-story concrete factory building in Mount Vernon, N. Y. for expansion of x-ray production.

SOLAR MFG. CORP. has moved its general offices from New York City to its main Eastern plant in North Bergen, N. J.

MAGNAVOX Co., Ft. Wayne, Indiana, has begun construction of a \$1,000,000 factory at Paducah, Kentucky for manufacture of loudspeakers,



New Magnavox plant now being built transformers, and household appliances.

TECHNICRAFT LABORATORIES, INC., Waterbury, Conn., has purchased the microwave and electronic laboratory facilities of the American

LITTELFUSE



Incorporated

4789 N. RAVENSWOOD AVE.

CHICAGO 40, U. S. A.

MITE-T-LITE · SWITCH-LITE · IGNITION-FRITZ · NEON INDICATORS · SWITCHES · CIRCUIT BREAKERS · FUSES, MOUNTINGS AND ACCESSORIES

TRIODES.....

The superiority of a triode amplifier is most apparent in the final test...listening

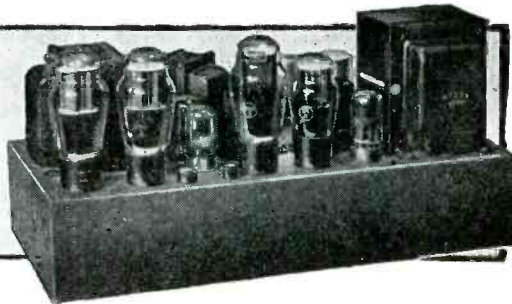

- ★TRIODE TUBES used throughout. 2—6B4G, 4—7A4, 2—7N7, 1—5U4G, 1—5Y3G.
- ★Three push-pull stages preceded by an inverter stage.
- ★Interstage transformer insures good push-pull balance.
- ★Flat within 1 db to 25 cycles at full power and to 4 cycles at reduced power.
- ★Flat within 0.2 db to 30,000 cycles.
- ★0.6% harmonic distortion and 0.2% intermodulation distortion at 5 watts.
- ★Rated power—30 watts at 2½% total distortion.

- ★AUTOMATIC BIAS CONTROL greatly increases undistorted power at moderate cost.
- ★Gain—55 to 120 db in various models.
- ★Bass and treble compensation—Two-stage tapped condenser-resistor networks.
- ★Input—38, 150, 500/600 and 500,000 ohms. Output—1.5 to 30 ohms and 500 ohms.
- ★Power available for other units—250 volts, 0.090 A DC; 6.6 volts, 5 A.
- ★Fuses—Main power and 6B4G plate line.
- ★Attractively finished chassis. High quality components. Finest workmanship.

The BROOK HIGH QUALITY AUDIO AMPLIFIER



Designed by LINCOLN WALSH

BROOK ELECTRONICS, Inc., 34 DeHart Place, Elizabeth 2, N. J.

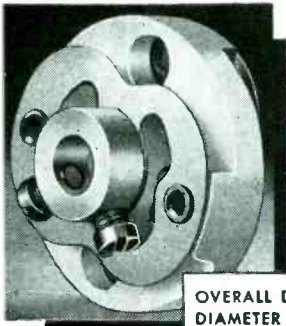

OVERALL DEPTH $1\frac{3}{16}$ INCH
DIAMETER $1\frac{1}{4}$ INCH
HUBS DRILLED FOR $\frac{1}{4}$ INCH
SHAFTS

FC-46-S INSULATED FLEXIBLE COUPLING

The FC-46-S is a sturdy flexible coupling which will provide a linkage between angularly misaligned shafts without causing backlash or play.

The forces developed in the coupling are uniform as the shaft is rotated, which gives you that SMOOTH feeling as you turn the shaft.

WRITE FOR FOLDER

HAMMARLUND

THE HAMMARLUND MFG. CO., INC., 460 W. 34TH ST., NEW YORK 1, N.Y.
MANUFACTURERS OF PRECISION COMMUNICATIONS EQUIPMENT

NEW Elinco Model G FRACTIONAL H.P. MOTOR

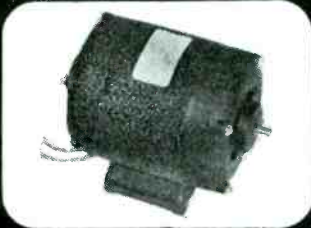

SYNCHRONOUS OR INDUCTION
MOTORS, DESIGNED AS SPLIT-
PHASE, SINGLE-VALUE CAPACI-
TOR, OR THREE-PHASE TYPES

THE new Model "G" Elinco motors are rated: as synchronous motors at 1 20 h.p. at 1800 r.p.m.; as induction motors at 1 10 at 1700 r.p.m.; 115 volts, 60 cycle A.C. A wide variety of other specifications can be filled depending on requirements.

Model "G" motors are 4-3 8" dia., 5-7 8" long, and internal fan cooled. Cast aluminum housings and end brackets, wrinkle finish. Equipped with ball bearings, single shield instrument type. Either base or face mounted. Available with automatic reset thermal overload protection, and as totally enclosed units at reduced ratings.

ELINCO DOES NOT MANUFACTURE OR CARRY STOCK MOTORS; ALL UNITS ARE PRODUCED TO ORDER IN SPECIAL HIGH-PRECISION INSTRUMENT-TYPE MOTORS AND GENERATORS—EITHER TO THE BASIC SPECIFICATIONS OR THEIR OVER 230 DIFFERENT TYPES, OR TO WHATEVER PHYSICAL OR ELECTRICAL VARIATIONS ARE REQUIRED TO MEET SPECIAL USES.

ELECTRIC INDICATOR CO.
PARKER AVE. STAMFORD, CONN.

ANOTHER
SPECIAL BY
PROGRESSIVE

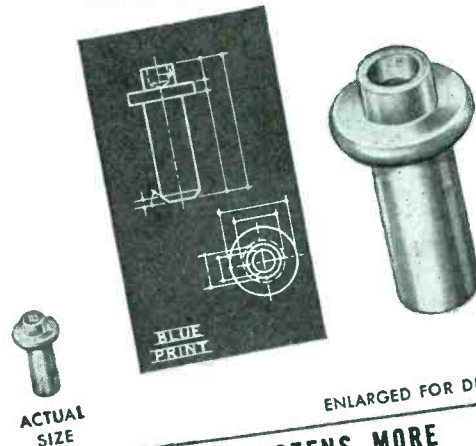

ACTUAL
SIZE

ENLARGED FOR DETAIL

CATALOG SHOWS DOZENS MORE

Special heads, threads and finishes on any metal or alloy adapted to cold upset. Weekly output: 25,000,000 pieces. Many specials, suggesting production savings for you, illustrated in latest catalog. Includes weights per 1M standard pieces, dec. equivs. of fractions, other purchasing and engineering helps. Write for Catalog 19.

The **PROGRESSIVE MFG. CO.**
50 NORWOOD ST. TORRINGTON, CONN.

ALL UNDER ONE ROOF!

JFD
PRECISION
MADE

We manufacture over 4000 different items for the Radio service trade and are prepared to ship

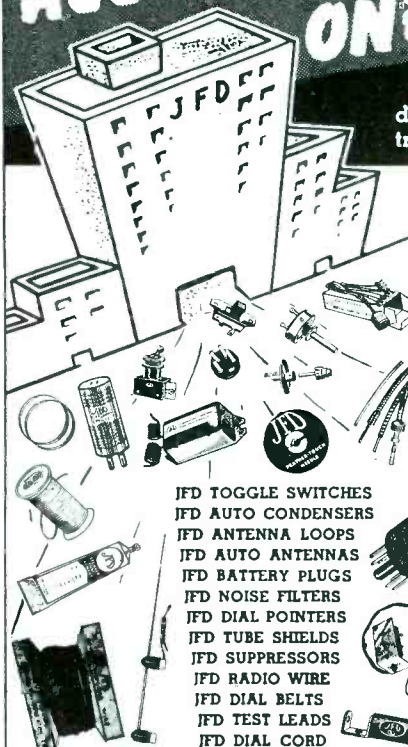

JFD TOGGLE SWITCHES
JFD AUTO CONDENSERS
JFD ANTENNA LOOPS
JFD AUTO ANTENNAS
JFD BATTERY PLUGS
JFD NOISE FILTERS
JFD DIAL POINTERS
JFD TUBE SHIELDS
JFD SUPPRESSORS
JFD RADIO WIRE
JFD DIAL BELTS
JFD TEST LEADS
JFD DIAL CORD

JFD "SOCKETTE" RADIO TUBE ADAPTERS
JFD EXACT DUPLICATE BALLAST TUBES
JFD SERVICEMEN'S ALIGNMENT TOOLS
JFD PHOSPHOR BRONZE DIAL CABLE
JFD FLEXIBLE SHAFTING & CASING
JFD BATTERY ADAPTER HARNESSES
JFD STEPDOWN RESISTANCE CORDS
JFD ADJUSTABLE BALLAST TUBES
JFD RESISTANCE CORD ADAPTERS
JFD SPEAKER CEMENT & SOLVENT
JFD FM & TELEVISION ANTENNAS
JFD REMOTE-O-CABLE REPLACER
JFD PHONO ADAPTER SWITCHES
JFD TRIK HOLD SCREWDRIVERS
JFD MICROPHONE CONNECTORS
JFD FM & TELEVISION LEADS
JFD STEPDOWN TRANSFORMERS
JFD WIRE WINDING MACHINES
JFD MIDGET JACKS & PLUGS
JFD HOME RECORDING DISCS
JFD AUTO RADIO FITTINGS
JFD BAKELITE DIAL KNOBS
JFD PHONOGRAPH NEEDLES
JFD RADIO TUBE SOCKETS
JFD NEUTRALIZING TOOLS
JFD STEPDOWN BALLASTS
JFD RESISTANCE CORDS
JFD AC SERVICE CORDS

J.F.D. MANUFACTURING CO. 4111 FT. HAMILTON PARKWAY
BROOKLYN 19, N. Y.

Simpler FM Analysis



with the

PANALYZOR

Eliminates tedious, time consuming point by point frequency checks. It shows simultaneously, in one complete picture, an FM'd carrier and resultant sidebands . . . in terms of relative frequency, amplitude and stability.

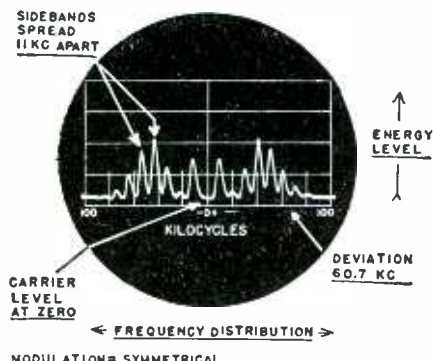

A single observation enables determination of such performance details as frequency deviation, energy distribution, sideband content, carrier shift and modulation symmetry . . . Operating procedures are simple . . . interpretations clear cut.

Actually, the PANALYZOR is a panoramic spectrum analyzer which shows, distributed in frequency, discrete quantities of r-f energy as vertical deflections on a cathode-ray tube.

Standard models now available with maximum scanning widths of 50 KC to 20 MC and corresponding resolutions of 2.5 KC to 100 KC.

Write, wire or phone now for recommendations, specifications, prices and delivery time.



NEWS OF THE INDUSTRY (continued)

Brass Company and the production equipment for the manufacture of flexible waveguides.

INSULINE CORP. OF AMERICA recently added another 25,000 sq ft to its modern plant facilities in Long Island City, N. Y.

ARLINGTON ELECTRICAL PRODUCTS, INC., 18 W. 25th St., New York 10, N. Y., was recently formed for the manufacture of audio equipment, motion picture items, and allied products.

ARCTURUS RADIO & TELEVISION CORP., Newark, N. J., newly-formed associate company of Standard Arcturus Corp., is now producing television receivers.

KENT CLIFF LABORATORIES, Peekskill, N. Y., has been organized by David F. Sklar for consultation, development, and manufacture of precision electronic and mechanical products.

RCA VICTOR DIVISION announces signing of a contract with Warner Bros. Pictures, Inc. for a joint program of research on large-screen television for theaters. In connec-



RCA vice-president W. W. Watts (left) and Col. N. Levinson of Warner Bros. demonstrate magnifying power of 42-inch spherical mirror used in RCA's large-screen television projection system

tion with the announcement, RCA executive vice-president Frank M. Folsom declared, "I am confident that in 1967 this company will be observing the 20th anniversary of large-screen television in the motion picture industry."

PERSONNEL

KENNETH A. SMITH, former RCA field engineer, has joined Primary Processes Ltd. of Los Angeles, Cal., as consultant and development director. He will specialize in re-

FOR PERSONALIZED
ATTENTION
TO YOUR
RESISTANCE WIRE
PROBLEMS



CONSULT JELLIFF

When confronted with any resistance problem, take advantage of the diversified experiences of Jelliff in selecting the proper alloys for your specific applications.

For recommendations, literature, prices and delivery of Jelliff Quality Alloys get in touch with our nearest sales representative or communicate direct with Southport, Connecticut. Write or phone for Prompt Action.

JELLIFF SALES REPRESENTATIVES

BOSTON, MASS. Phone: LIBERTY 1277
White Sales Co., Room 502, 10 High St.

CHICAGO, ILL. Phone: STATE 5292
William Maxwell Co., 107 N. Wacker Drive

CLEVELAND, OHIO Phone: MAIN 8585
A. J. Loeb Sales Co., 1836 Euclid Ave. So.

LOS ANGELES, CALIF. Phone: TRINITY 7353
Perlmuth-Colman Associates, 942 Maple Ave.

MINNEAPOLIS, MINN. Phone: GENEVA 3373
Volco Company, 622 McKnight Building

NEW YORK, N. Y. Phone: CALEDONIA 5-1776
R. B. Dana Company, 101 Park Ave.

PHILA., PA. Phone: KINGSLEY 5-1205
S. K. MacDonald, 1531 Spruce St.

PITTSBURGH, PA. Phone: CEDAR 3000
Wm. M. Orr Co., 1228 Brighton Rd.

ROCHESTER, N. Y. Phone: MONROE 5392
J. R. Hanna, P. O. Box 93, Brighton Station

SEATTLE, WASH. Phone: SE-0193
Perlmuth-Colman Associates, 704 Third Avenue

HULL, QUE., CANADA
Mica Co. of Canada, Ltd., P. O. Box 189



★ STAR VITAL AIDS

FOR THE

Manufacturers of 7-pin and 9-pin miniature tube—radios and equipment



#JE-9 (9-pin)—#JE-10 (7pin)
—Star Miniature socket wiring plugs for accurate alignment of miniature socket contacts during wiring. Precision cast of zinc base alloy—pins of stainless steel.

#JE-15 (9-pin)—
#JE-13 (7-pin)—
Star Miniature tube pin straighteners (with stainless steel insert) to obtain a perfect fit when the tube is placed in the equipment.



Scientifically designed—Precision made
READY FOR IMMEDIATE DELIVERY
IN ANY QUANTITIES

STAR EXPANSION PRODUCTS CO. INC.

147 Cedar St.

New York 6, N. Y.

BAACH-INTERNATIONAL

EIGHT HEAD HOT CUT FLARE MACHINE

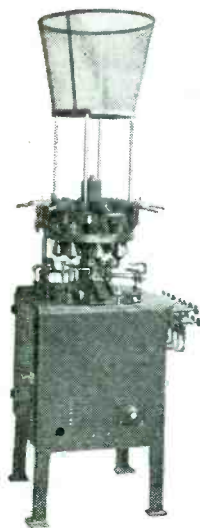

Dimensions
24"x24"x72" high

Automatic throughout.
Can be synchronized with automatic Stem machine.

Cuts off and flares in one operation.

Production 1250 flares per hour. For miniature flares, fluorescent starters, standard size lamps, fluorescent and radio tubes.

RANGE OF MACHINE

Glass tubing
27 to 45 gauge

Length of flares
5 mm. to 80 mm.

Forms flares up to
47 mm. diam.

Net weight, 960 lbs.
Gross weight
1450 lbs.

INTERNATIONAL MACHINE WORKS

Manufacturers of High Vacuum Pumps, Automatic Machinery for Incandescent Lamps, Electronic Tubes since 1916.

2027 - 46TH STREET

NORTH BERGEN, N. J., U. S. A.

Tel. UNion 3-7412

Cable Address "Intermach" North Bergen, N. J.

Use LINDE Synthetic Sapphire At Points of Wear



LINDE synthetic sapphire offers definite advantages for small parts at points of wear. Sapphire is hard—takes and retains a high polish. These properties show why.

- | | | | |
|-----------------------------|----------------|----------------------------|---|
| 1. Hardness (Knoop) | 1,525 to 2,000 | 4. Chemical Resistance | All acids |
| 2. Melting Point | 2,030 deg. C. | 5. Coefficient of Friction | 0.140
(ring bearing against high-carbon steel pivot) |
| 3. Unicrystalline Structure | | | |



Half-boules, weighing up to 150 carats

Rods, 0.065-in. to 0.125-in. diameter

Write for the LINDE Synthetic Sapphire Technical Data Sheet No. 3. It may suggest further uses where you have problems of small parts wear.

THE LINDE AIR PRODUCTS COMPANY

Unit of Union Carbide and Carbon Corporation

30 East 42nd Street  New York 17, N. Y.

In Canada:

Dominion Oxygen Company, Limited, Toronto

The word "Linde" is a trade-mark of The Linde Air Products Company



THERMOSTATIC METAL TYPE DELAY RELAYS

PROVIDE DELAYS RANGING
FROM 1 TO 120 SECONDS

FEATURES:—Compensated for ambient temperature changes from -40° to 110° F... Hermetically sealed; not affected by altitude, moisture or other climate changes... Explosion-proof... Octal radio base... Compact, light, rugged, inexpensive... Circuits available: SPST Normally Open; SPST Normally Closed.

PROBLEM? Send for "Special Problem Sheet" and Bulletin.

AMPERITE REGULATORS

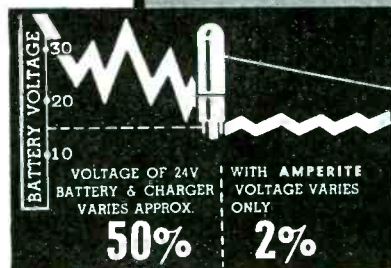

Amperite REGULATORS are the simplest, lightest, cheapest, and most compact method of obtaining current or voltage regulation... For currents of .060 to 8.0 Amps... Hermetically sealed; not affected by altitude, ambient temperature, humidity.

Write for 4-page Illustrated Bulletin.

AMPERITE CO., 561 Broadway, New York 12, N. Y.

In Canada: Atlas Radio Corp., Ltd., 560 King St., W. Toronto

POLARAD

TELEVISION Equipment

for studio • laboratory • manufacturer

SYNCHRONIZING GENERATOR

Model PT 101—Television

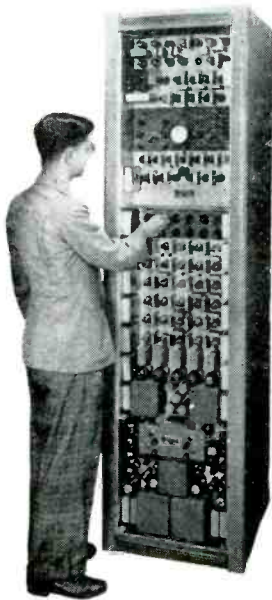

FEATURES

- Built-in 3" oscilloscope with synchronized sweeps for viewing Timing and Video Output pulse wave forms.
- Synchronized marker system for checking pulse width and rise time.
- Extreme stability, insured by deriving all pulses from leading edge of master oscillator pulse.
- Means for checking synchronizing pulses in odd and even fields.

SPECIFICATIONS

525 line, interlaced, 60 fields, 30 frames, RMA Synchronizing pulses held to tolerance specified in the NRTPB report of 1945. Output Pulses: Synchronizing, Video Blanking, Camera Blanking, Horizontal Driving, Vertical Driving Pulses. 5 volts across 100 ohm termination. Dual output jacks. 115 volts 50/60 cps. Complete with tubes.

TELEVISION MONOSCOPE SIGNAL SOURCE

Model PT 102

- Composite Video Signal
- Wide Band Video Amplifier, 6 DB down at 10MC
- Dual outputs for feeding two 75 or 100 lines
- Black positive or Black negative output
- Resolution greater than 600 lines

INPUT: Vertical and Horizontal Driving pulses, Camera and Kinescope Blanking Pulses.

OUTPUT: Composite Video Signal, 3 volts, 100 ohm line 115 volts 50/60 cps. Complete with tubes and including high and low voltage power units.

9 FERRY STREET
NEW YORK 7, N. Y.

Polarad

Electronics Company

Television engineers and consultants to the nation's great television stations.

NEWS OF THE INDUSTRY (continued)

search and installation of new applications of electronics and ultrasonics in food packaging, processing, and sterilization.

ROBERT F. JONES, JR., Lima, Ohio, received unanimous Senate confirmation as new member of the FCC. He will resign as a congressman to fill the post left by former Commissioner Ray C. Wakefield.



R. F. Jones, Jr.



M. V. Kiebert, Jr.

MARTIN V. KIEBERT, JR., has joined the firm of Sherman Fairchild and Associates, New York City, and will serve as consultant on aircraft telemetering, radar, servo mechanisms, remote control, and instrumentation.

NICHOLAS J. ROSE, now with National Radio Research Laboratories in New York City, will specialize in mechanical applications of electronic controls on a consultant basis.

P. C. SANDRETTO has been named director of aviation for the International Telecommunication Laboratories. He joined IT&T late last year upon leaving the Army as a full colonel and receiving a citation and a Bronze Star for his electronics work and its contribution to the efficiency of the B-29 program in the Central Pacific.

CHARLES J. PANNILL, with RCA since 1928, recently retired as president and director of Radiomarine Corp. of America.

HARRY C. INGLES has been elected a director of Radio Corporation of America, succeeding Edward W. Harden who retires after serving on the board since 1919.

L. M. TEMPLE has been appointed chief engineer of the battery division of the Winchester Repeating Arms Company division of Olin Industries, Inc. He was formerly chief engineer of the Eveready divi-

BRADLEY

PHOTO ELECTRIC CELLS



SIMPLIFY PHOTO-ELECTRIC APPARATUS

Luxtron* photocells convert light directly into electrical energy. No external source of voltage is required. Meters and relays can be operated directly from Bradley Luxtron photocells, improving control over manufacturing operations, reducing your costs. They meet the most exacting requirements. Advanced manufacturing techniques make light-actuated Bradley cells the choice all over the world.

Besides the housed model shown with its plug-in contacts, Bradley also offers tube socket, nut-and-bolt types and pigtail contact mountings. In addition, Luxtron unmounted cells are available in many different sizes and shapes.

*U. S. PAT. OFF.

Illustrated literature, available on request, shows more models of Bradley photocells, plus a line of copper oxide and selenium rectifiers. Write for "The Bradley Line."

BRADLEY

LABORATORIES, INC.

82 Meadow St. New Haven 10, Conn.

COLLINS
FM and FM/AM TUNERS

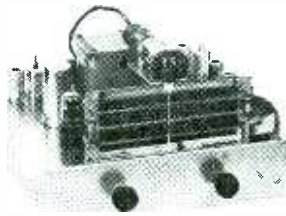

11 tube FM chassis unit

17 TUBE
FM/AM
TUNER.
CUSTOM
BUILT
TO YOUR
ORDER

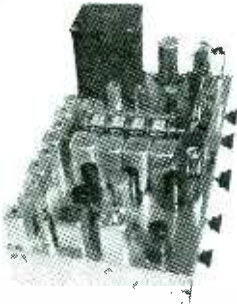

Write for literature on our FM components and matched amplifiers

Collins Audio Products Co., Inc.
126 Park Street Westfield, N. J.

speed production — cut costs with
EJECT-O-MATIC
AUTOMATIC-FEED SOLDERING IRONS AND ACCESSORIES



**HEAVY DUTY
EJECT-O-MATIC**

High-heat 100 and 150-watt models for general heavy electrical, electronic and repair work. Also available in long-nosed "instrument" model. Weight only 22 oz.



**STANDARD
EJECT-O-MATIC**

Popular 50 and 75-watt models for general radio and electrical work. Special long-nosed models available for soldering inside deep receptacles, hard-to-get relays and assemblies. Weight only 18 oz.



VERTI-MOUNT

Treadle operated — leaves both hands free to hold work. Pre-heats and solders work with one easy foot movement. Takes all Eject-O-Matic irons.

complete line now available

TIPS— Multi-clad tips available in eight different sizes and shapes.

SPECIAL TIPS DESIGNED—
MINIMUM 10 TO ORDER.

Send for new catalog and prices.



MULTI-PRODUCT TOOL CO. 123 SUSSEX AVENUE, NEWARK, N. J.



Linde

ARGON
HELIUM
KRYPTON
NEON
XENON

and Standard or Special
MIXTURES

LINDE rare gases are spectroscopically pure—argon, helium, neon, and standard mixtures are available in one- and two-liter glass bulbs and in cylinders; xenon and krypton are available in liter and fractional-liter bulbs.

The word "Linde" is a trade-mark of

THE LINDE AIR PRODUCTS COMPANY
Unit of Union Carbide and Carbon Corporation
30 East 42nd St. **UCC** New York 17, N. Y.

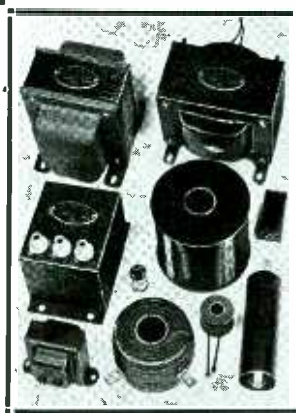

**N. W. L. CUSTOM MADE
ELECTRICAL**

**COILS & TRANSFORMERS
FOR ELECTRONIC APPLICATIONS**

More than 20 years of special coil and transformer manufacturing for industry, laboratory, research and instrument makers.

- Units 50 VA to 100 KVA, 60 to 400 Cycles only.
- Prompt Service on single or small lots.
- Specialist in special transformers & coils for research, experimental and product development work.



Nothelfer Winding Laboratories
9 Albemarle Ave. Trenton 3, N. J.

INSTRUMENT HOUSINGS · PANELS · CHASSIS
Manufactured to your Requirements

Experienced fabrication and dependable service for all types of radio and electronic parts. Send us your drawings and specifications for quotation.

STAMFORD METAL SPECIALTY CO., 429 W. BROADWAY, N. Y. 12
Metal Work of Every Description

TWIN POWER SUPPLY

**Electronically
Regulated for
precise
measurements**

Two independent sources of continuously variable D.C. are combined in this one convenient unit. Its double utility makes it a most useful instrument for laboratory and test station work. Three power ranges are instantly selected with a rotary switch:

- 175-350 V. at 0-60 Ma., terminated and controlled independently, may be used to supply 2 separate requirements.
- 0-175 V. at 0-60 Ma. for single supply.
- 175-350 V. at 0-120 Ma. for single supply.

In addition, a convenient 6.3 V.A.C. filament source is provided. The normally floating system is properly terminated for external grounding when desired. Adequately protected against overloads.



- Output voltage variation less than 1% with change from 0 to full load.
- Output voltage variation less than 1 V. with change from 105 to 125 A.C. Line Voltage.
- Output ripple and noise less than .025 V.

Twin Power Supply Model 210 Complete \$115.00 F.O.B. Chicago
Dimensions: 16" x 8" x 8" Shipping Wt. 35 lbs.
(Other types for your special requirements)

SOME TERRITORIES STILL AVAILABLE FOR REPRESENTATIVES

FURST ELECTRONICS

806 W. NORTH AVENUE, CHICAGO 22, ILLINOIS

NEWS OF THE INDUSTRY (continued)

sion, National Carbon Co., and there developed an economizer circuit for portable radios.

PHILIP I. MERRYMAN, formerly manager of the planning and development division of NBC, has formed a new firm of radio consultants in partnership with H. V. Anderson of New Orleans.



P. I. Merryman



S. Bracken

STANLEY BRACKEN, executive vice-president of Western Electric Co., was elected president to succeed retiring president Clarence G. Stoll.

CLARK C. RODIMAN, managing editor of QST for over 10 years before the war, is now with National Co., Inc., Malden, Mass.



C. C. Rodiman



R. K. Dixon

ROBERT K. DIXON, previously engaged in radar beacon development at Submarine Signal Co., is the newly appointed product manager of broadcast equipment in Raytheon's Commercial Products Division.

GEORGE J. MAKI, previously associated with Collins Radio Co., has established his own office as radiotelegraph consultant at Moraga, Cal.

ARTHUR WINTERS has established Winters Radio Laboratory at 11 Warren St., New York City for specialized servicing of communication equipment and television receivers. His firm is now the authorized Hallicrafters service center for the northeastern area.

Now ready for you....

**FACTS ABOUT A NEW
SILVER BRAZING ALLOY
THAT STREAMLINES
DESIGN, PRODUCTION, COSTS**



**WRITE FOR A COPY TODAY
...ASK FOR BULLETIN 15**

H A N D Y & H A R M A N

82 FULTON ST., NEW YORK 7, N. Y.

Bridgeport, Conn. • Chicago, Ill. • Los Angeles, Cal. • Philadelphia, Pa. • Toronto, Canada

Agents in Principal Cities

WHO'S WHO IN SOUND



A174 Has the solution to special cases...

Internationally famous detectaphone, midget transmitter, call system, experimental and special operator. "Pocket watch" size. Well insulated. 200 Ohms. Level: -12db (6 mv/100 bars). Ask for

UNIVERSAL A174 CARBON MICROPHONE

See Our Exhibit 3rd Annual Electronics Trade Show, San Francisco, Sept. 26, 27, 28



UNIVERSAL MICROPHONE CO
Inglewood 3 California

COAXIAL CABLE RELAYS

for high frequency switching

Two Sizes: 50 Watt and 250 Watt Capacity
—standard coil operating voltages AC or DC.

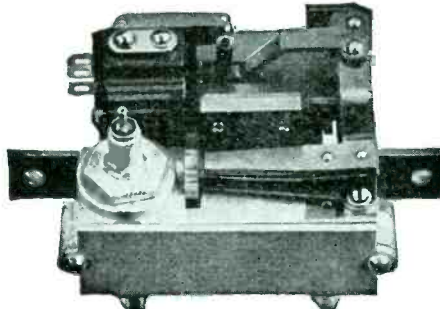

(2/3rds actual size)



(1/3 actual size)

Write for Descriptive Literature CE6

KEYING RELAYS • SENSITIVE AND MEDIUM DUTY POWER RELAYS

SIGNAL ENGINEERING & MFG. CO.
154 WEST 14th St., NEW YORK 11, N. Y.

Crystals for the Critical.

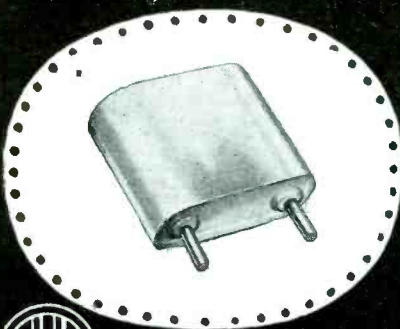

"STABILIZED"

H17 CRYSTAL FOR AIRLINES AND VHF EQUIPMENT

Especially designed for all types of airline and VHF equipment, the H17 "Stabilized" Crystal is rendering outstanding performance in this equipment. Pin spacing permits two units to be mounted in loctal socket.

When developing new equipment, write JK for pre-production samples. Just address the Specification Department.

Write For Illustrated Folder

The JAMES KNIGHTS CO.
SANDWICH, ILLINOIS



Preferred

as a source of precision-made WASHERS and STAMPINGS manufactured to your specifications

CUP WASHERS
for Binding Screws



WHITEHEAD STAMPING CO.
1691 W. Lafayette Blvd. Detroit 16, Michigan

**JUST ANOTHER TRANSFORMER?
OR GUARANTEED
TERMINAL PERFORMANCE!**

TRANSFORMERS - COILS

Any or all Types built to individual specifications
RESEARCH-DESIGN-PRODUCTION
Single Items or Quantity Production

GOSLIN ELECTRIC AND MANUFACTURING CO.
2921 WEST OLIVE STREET BURBANK, CALIFORNIA

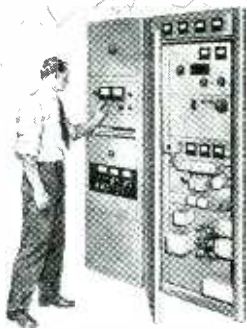

How Much Competition Have You

... For Your Present Job
... For a Better Job?

Again employers can afford to be "selective", particularly with thousands of new, ambitious, young men who have entered the radio industry since the war. This means you must improve your technical knowledge not only to qualify for the better job you want, but to hold the job you now occupy.

Your own success in radio depends upon the effort you make now to fortify yourself with modern technical training. You may have "gotten by" up to this point. But, if you are like some radio-men, many wartime and postwar technical advances of the industry have passed you by. If you want to progress with the industry... if you want an important, good-paying position and the future security that goes with it—you must acquire up-to-date technical training.

We invite you to investigate the CREI proved program for professional self-improvement for which thousands of professional radiomen have enrolled since 1927. CREI can help you by providing down-to-earth, practical technical training that should equip you to advance to the better-paying radio jobs and step ahead of competition.

The facts about CREI and what it can do for you are interestingly described in our 24-page booklet. It is well worth your reading. Send for it today.

VETERANS! CREI TRAINING AVAILABLE UNDER THE "G.I." BILL!

CAPITOL RADIO ENGINEERING INSTITUTE

An Accredited Technical Institute
Dept. E-9, 16th & Park Rd., N. W.
Washington 10, D. C.

MAIL COUPON FOR FREE BOOKLET

CAPITOL RADIO ENGINEERING INSTITUTE
16th & Park Road, N. W., Dept. E-9, Wash. 10, D. C.
Gentlemen: Please send me your free booklet, "CREI training for your better job in RADIO-ELECTRONICS", together with full details of your home study training. I am attaching a brief resume of my experience, education and present position.

CHECK PRACTICAL RADIO ENGINEERING COURSE PRACTICAL TELEVISION ENGINEERING

NAME
STREET
CITY ZONE STATE

I am entitled to training under the G. I. Bill.

NEW BOOKS

Klystron Tubes

By A. E. HARRISON, Assistant Professor of Electrical Engineering, Princeton University; formerly klystron applications engineer, Sperry Gyroscope Co. McGraw-Hill Book Co., New York, 1947, 271 pages, \$3.50.

BEHAVIOR of various types of klystrons is explained as a detailed introduction to them for both tube designers and electronic application engineers. The book coordinates functions of cavities and electron beams as used in amplifier, multiplier, oscillator, and detector klystrons. Methods of modulation and measurement are also described.—F.R.

Theory and Application of Radio-Frequency Heating

By GEORGE H. BROWN AND CYRIL N. HOYLER, research engineers at RCA Laboratories, and RUDOLPH A. BIERWIRTH, chief engineer of Sound Inc., Chicago. D. Van Nostrand Co., Inc., New York, N. Y., 1947, 370 pages, \$6.50.

FOR INDUSTRIAL engineers considering the use of r-f generators for solving heating problems, the authors have combined in this one distinguished volume the pertinent basic principles, design equations, and practical application data for both induction and dielectric forms of electronic heating.

Maximum emphasis is placed on the nature of current flow in various metal shapes and on the design of work coils for surface or all-through heating of good conductors, and rightly so because this form of electronic heating predominates in manufacturing plants. The first ten chapters thus lay the groundwork for chapter 11 on annealing brass and bronze, chapter 12 on typical induction heating problems such as paint baking and multiple soldering, three following chapters on heat flow equations for metals, and chapter 16 on case hardening of steel. Included among the first ten chapters are details of such specific applications as heat treatment of knitting needles and surgical needles, heating of thin metal strip, and heating of laminar sheets such as copper-clad steel.

Of the eight chapters devoted to heating of poor conductors, chapter

**SPEED!
ACCURACY!
SIMPLICITY!
EFFICIENCY!**



Automatic PUSH-BUTTON SELECTION

The NEW Precision

Multi-Master

Series 847

5000 AND 1000 OHMS PER VOLT DC—
1000 OHMS PER VOLT AC

High speed, 54 range, high sensitivity, AC-DC multi-range tests set. Ranges to 6000 volts, 200 megohms, 12 amperes, + 70 DB.

A rugged, high sensitivity, general purpose AC-DC test set, designed to withstand the continuous use associated with electronic maintenance and service, classroom instruction, production testing, etc. • 200 microampere, 4 5/8" meter. • All standard functions at only two jacks. • 200 megohm insulation resistance test range. • Recessed 6000 volt safety jacks. • Etched-Anodized aluminum panels resistant to moisture and wear. • Conservatively and professionally designed.

RANGE SPECIFICATIONS

★ 24 AC-DC voltage ranges to 6,000 volts at both 5,000 and 1,000 ohms per volt DC. 1,000 ohms per volt AC. Initial range 0-3 volts.

★ 8 DC current ranges to 12 amperes.

★ 6 ohmmeter ranges to 200 megohms.

★ 8 decibel ranges — 26 DB to + 70 DB.

★ 8 output ranges to 6,000 volts.

MODEL 847-L; modern, shallow, Bakelite laboratory type case.....\$42.90

MODEL 847-P; portable, hardwood case with tool compartment and cover.....\$44.90

(Prices complete with batteries and High Voltage test leads.)

ASK to see the full "Precision" line of Quality Test Instruments on display at all leading radio parts and equipment distributors. Signal generators, Vacuum Tube Voltmeters, Tube Testers, Multi-range Test Sets, etc. . . .

Write for new Precision 1948 Catalog

PRECISION

APPARATUS CO., Inc.

92-27 Horace Harding Blvd.

Elmhurst 10, N. Y.

Export Division: 458 Broadway, N. Y. City, U.S.A.
Cables: MORHANEX

VIBRO MASTER TYPE K

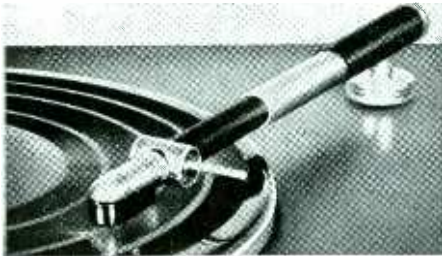

PROFESSIONAL ARM

FOR GE VARIABLE RELUCTANCE
AND PICKERING 120M CARTRIDGES

Designed by VIN BROYLES

- 1... will neither introduce nor amplify lateral distortion.
- 2... resonance characteristic flat plus or minus ½ DB 40 to 1000 cycles.
- 3... balances GE cartridge at 22 grams and Pickering 120M at 15 grams stylus pressure.
- 4... morning after handle prevents record damage when cueing.

NET PRICE... (less cartridge) \$34.50

see your distributor or write

TECHNICAL PRODUCTS
INTERNATIONAL
144 West 54th Street, New York City 19



PILOT LIGHT ASSEMBLIES

PLN SERIES—Designed for

NE-51 Neon Lamp

Features

- THE MULTI-VUE CAP
- BUILT-IN RESISTOR
- 110 or 220 VOLTS
- EXTREME RUGGEDNESS
- VERY LOW CURRENT

Write for descriptive booklet



The DIAL LIGHT CO. of AMERICA

FOREMOST MANUFACTURER OF PILOT LIGHTS

900 BROADWAY, NEW YORK 3, N. Y.

Telephone—Algonquin 4-5180

FS-135-C FREQUENCY STANDARD

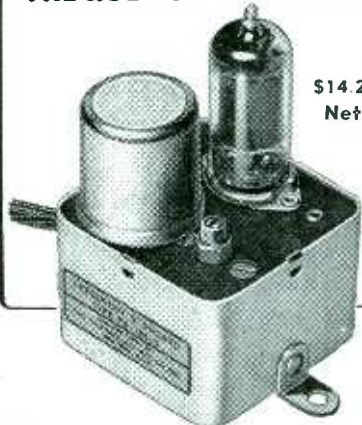

\$14.25
Net

**Keeps you
"ON THE BEAM"**

No more "hoping" you're in the band. Mount the FS-135-C Frequency Standard in your receiver, zero beat it with WWV and you'll have a frequency meter that is really accurate.

HAMMARLUND

THE HAMMARLUND MFG. CO., INC., 400 W. 34th ST., NEW YORK 1, N. Y.
MANUFACTURERS OF PRECISION COMMUNICATIONS EQUIPMENT



To your specifications

QUADRIGA Quality WASHERS

Fulfill the rigid standards of
electrical and electronic services

Make sure, by entrusting your washer requirements to long experience, ample facilities. Any quantity small or large: Special Flat—Tension and Spring—Formed and Drawn—Cupped and Finishing—Friction—Irregular Contour—Dished Blanks, etc. Wire terminals. SMALL STAMPINGS, any design. Ask for catalog.

THE QUADRIGA MANUFACTURING CO.

Est. 1894 "Half a Century"

221A W. Grand Ave.

Chicago 10, Ill.





LOOK TO



NEW! More Comfortable Grip!

Have your dealer show you the new XCELITE screw driver! See how it helps you work faster, easier. Feel the smooth, comfortable, SURE-GRIP genuine XCELITE handle—wear proof, break proof, shock and fire resistant! Husky CHROME VANADIUM BLADE, precision ground on flat belt to fit screw slot snugly. XCELITE is the choice of experts. You'll use it many efficient years! Order now!

Originalists—not Imitators

PARK METALWARE CO., INC.

Dept. C Orchard Park, New York

PREFERRED BY EXPERTS

For Originality
Quality Tools

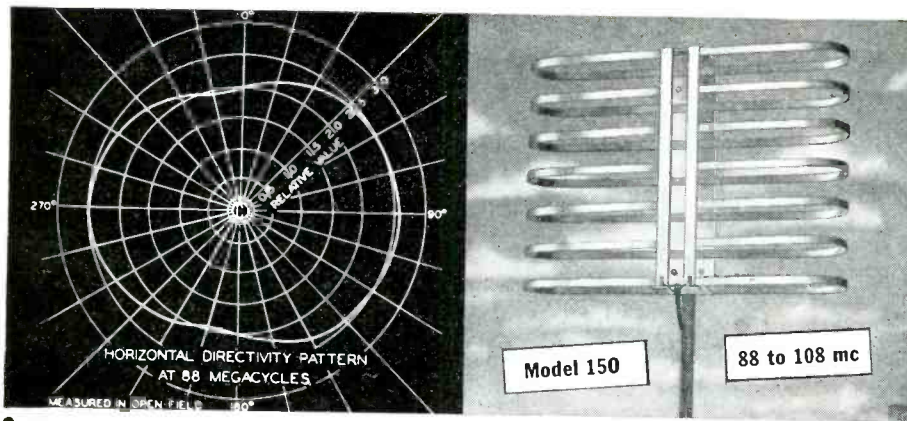

The New Rauland Omni-directional* FM ANTENNA!

- No Special Orientation Required
- High Sensitivity & Signal Strength
- Low Standing Wave Ratio
- All-Aluminum Construction

NON-DIRECTIONAL DESIGN!

Graph above shows virtually circular horizontal directivity pattern at 88 mc; only slight elongation appears at 108 mc. Vertical directivity shows no response to automobile ignition and other man-made noises; gives maximum noise-reducing benefits.

*Mfd. under Alfred Alford inventions

Here is the *first and only* FM Receiving Antenna to offer *all* these features: Non-Directional Pickup over the *entire* FM band—for satisfactory reception from all stations in any location regardless of direction of signal. Higher gain improves reception at outlying sections of the effective station area. Stable-Omnidirectional characteristics—unaffected by rain, sleet, or age. Small, rugged, and supplied completely assembled—easy to install. Can be used in pairs for increased signal strength and lower noise. Can be permanently grounded for protection against lightning. Direct match to standard 300 ohm receivers (matching unit can be supplied to match other impedances). No other conventional antenna offers all the FM receiving advantages obtained from the exclusive design of the RAULAND Model 150 FM Receiving Antenna.

Rauland

Write for interesting descriptive bulletin . . .

THE RAULAND CORPORATION

4265 N. Knox Avenue, Chicago 41, Illinois

TOP PERFORMANCE with —

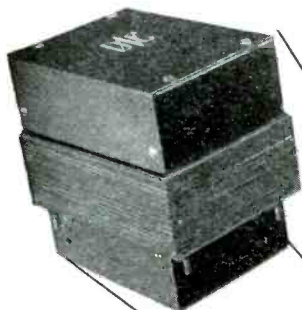

DINION

Transformers and Coils

Plan for performance perfection. For transformers and electrical coil windings of superior quality and production, use Dinion Transformers and Coils. Manufactured to specification or designed to meet particular requirements. Special or mass production.

- Photo Flash Control • Radio
- Instrument • Television
- Electronic and Industrial Applications
- Electrical Coil Windings

Specialists in Difficult Designs



DINION COIL CO., INC. CALEDONIA NEW YORK

17 deals solely with theory and the remainder cover specific applications. These include wood-gluing presses, r-f sewing machines for sheet plastics, r-f dehydration, pasteurization, sterilization, and cooking of food, and heating of drugs and other materials.

The mathematical derivations throughout the book, supplemented by a three-part mathematical appendix, make this excellent book equally as valuable to the design engineer as to the industrial engineer concerned primarily with the engineering of economic electronic heating applications in plants.—J.M.

The Physical Principles of Wave Guide Transmission And Antenna Systems

By W. H. WATSON, *Professor of Mathematics, University of Saskatchewan. Oxford University Press, London, 1947, 207 pages, \$7.00.*

PROPERTIES of slot couplings and antenna arrays fed from waveguides were extensively studied during the war. In this presentation of the studies, a preliminary chapter reviews the impedance concept used in exploring guided wave phenomena. Propagation in waveguides and auxiliary components is described as background for the development of slot couplings and radiators, the latter constituting the major portion of this book for design engineers and physicists.—F.R.

German-English Dictionary for Electronics Engineers and Physicists

By BERNARD R. REGEN AND RICHARD R. REGEN. *Published by J. W. Edwards, Ann Arbor, Mich., 1946, 358 pages, \$6.00.*

NEARLY 21,000 German technical terms in the fields of electronics and physics are listed alphabetically with English equivalents, providing an invaluable key to the great mass of German-language literature collected in Germany since the war and available from the Superintendent of Documents, Washington, D. C. In many instances brief explanatory definitions have been added to clarify the

PHOTOVOLT

Electronic PROCESS TIMER



An adjustable timing relay for timing periods 1/20 to 50 sec.

- for welding, process timing, printing, control of machinery, and protection of electronic tubes
- for single actuation as well as sequence timing and recycling in continuous operation
- for AC of any frequency and for DC

Write for Bulletin #950

PHOTOVOLT CORP.

95 Madison Ave. New York 16, N. Y.

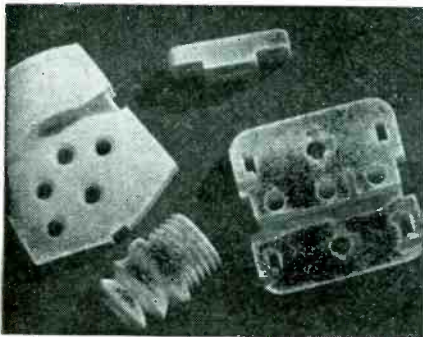

Lavite

STEATITE CERAMIC

Properties and Characteristics of Our LAVITE S1-5 Steatite Ceramic Body

Compressive Strength	96,000 lbs. per square inch	
Tensile Strength	7,200 lbs. per square inch	
Flexural Strength	10,500 lbs. per square inch	
Modulus of Rupture	20,000 lbs. per square inch	
Dielectric Strength	235 volts per mil	
Dielectric Constant	6.42	} Frequency of Loss Factor
Loss Factor	2.90	
Power Factor	0.448	1 megacycle
Bulk Specific Gravity	2.664%	
Density (from above gravity)	0.096 lbs. per cubic inch	
Hardness (Mohr scale)	7-0	
Softening temperature	2,350°F.	
Linear Coefficient of Expansion	8.13x10 ⁻⁶	
Moisture Absorption (ASTM D-116-42-A)	0.009%	

Design engineers and manufacturers in the radio, electrical and electronic fields are finding in LAVITE the precise qualities called for in their specifications . . . high compressive and dielectric strength, low moisture absorption and resistance to rot, fumes, acids, and high heat. The exceedingly low loss-factor of LAVITE plus its excellent workability makes it ideal for all high frequency applications.

We will gladly supply samples for testing.

D. M. STEWARD MFG. COMPANY

Main Office & Works: Chattanooga, Tenn.
Needham, Mass. • Chicago • Los Angeles
New York • Philadelphia

MOLDED S.S. White RESISTOR

The "All-Weather" Resistors



- Noiseless in operation
- Strong and durable
- Good performance in all climates

STANDARD RANGE

1000 ohms to 10 megohms

- NOISE TESTED •

At slight additional cost, resistors in the Standard Range are supplied with each resistor noise tested to the following standard: "For the complete audio frequency range, resistor shall have less noise than corresponds to a change of resistance of 1 part in 1,000,000."

HIGH VALUES

15 to 1,000,000 megohms

S.S. WHITE INDUSTRIAL

THE S. S. WHITE DENTAL MFG. CO. DEPT. R. 10 EAST 40th ST., NEW YORK 16, N. Y.



FLEXIBLE SHAFTS • FLEXIBLE SHAFT TOOLS • AIRCRAFT ACCESSORIES
SMALL CUTTING AND GRINDING TOOLS • SPECIAL FORMULA RUBBERS
MOLDED RESISTORS • PLASTIC SPECIALTIES • CONTRACT PLASTICS MOLDING

One of America's AAAA Industrial Enterprises

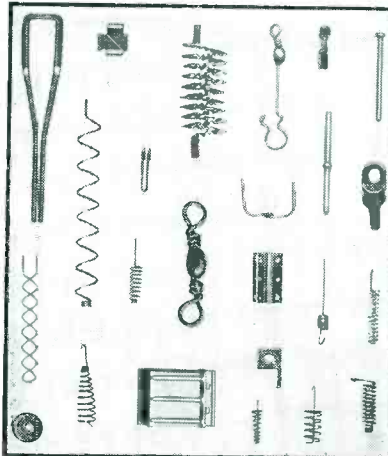

SMALL PARTS

Filaments, anodes, supports, springs, etc. for electronic tubes. Small wire and flat metal formed parts to your prints for your assemblies. Double pointed pins. Wire straightened and cut diameter up to 1/8-inch. Any length up to 12 feet. LUXON fishing tackle accessories. Inquiries will receive prompt attention.

ART WIRE AND STAMPING CO.

227 High St.

Newark 2, N. J.

PAMARCO DE-REELING TENSION

PAMARCO tensions are the perfect answer to lower coil winding costs!

- * FINGER-TIP TENSION CONTROL
- * OPERATOR MAKES OWN ADJUSTMENTS
- * NO TOOLS OR ACCESSORIES NEEDED
- * FITS ALL COIL WINDERS

The free-running action of the PAMARCO tension practically eliminates defective coils. Their compact size permits more simultaneous coil winds on any machine. Operator makes all adjustments for any gauge wire with simple thumbscrew.

Write for literature today

SHORT CUT TO PERFECT COILS!



PAPER MACHINERY & RESEARCH, INC.
1014 OAK STREET • ROSELLE, NEW JERSEY



SILICONE DIFFUSION PUMP FLUIDS Improve Adhesion of Metal Films

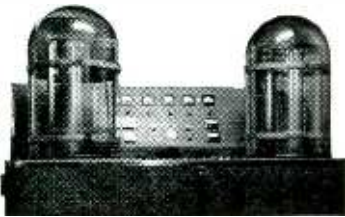

COURTESY DUPLATE CANADA, LTD.

Use of DC 703 in production units for the thermal evaporation of metallic and non-metallic films indicates that the exceptional heat stability of this DC Silicone Diffusion Pump Fluid results in better adhesion of magnesium fluoride films to glass.

After using DC 703 for the past year in two production units for evaporating magnesium fluoride and rhodium, Dr. Bateson of Duplate Canada Ltd., Oshawa, Ontario, reports that he has had no difficulty in producing equal or higher vacuum with pumping speeds equal to those of a high grade organic pumping fluid.

Even more significant are Dr. Bateson's observations that backstreaming seems to be reduced by use of DC 703; that the Silicone-vapor which does migrate into the system is more heat-stable; and that primary adhesion of magnesium fluoride films to glass is therefore improved. Preliminary observations also indicate that use of DC 703 results in brighter first surface mirrors.



That DC 703 causes less contamination of the system is further indicated by these aluminum shields. Both were normally exposed to the heaters in the bell jar for 9 months. Shield at left, exposed to DC 703, is quite clean. The other shield, exposed to a high grade organic pumping fluid, is covered with a dark brown deposit.

May we also remind you of DC 702. Both DC 702 and DC 703 are useful in electron microscopes, high vacuum dehydration and in evacuating electronic tubes. Write for pamphlet No. 9-4.

DOW CORNING CORPORATION MIDLAND, MICHIGAN

New York • Chicago • Cleveland • Los Angeles
In Canada: Fiberglas Canada, Ltd., Toronto
In England: Albright and Wilson, Ltd., London



NEW BOOKS

(continued)

distinction between similar terms in both languages.

Terminology current in 1939 is covered, along with all other terms falling within the scope of the dictionary that could be found in books, scientific journals, and patent literature published in Germany during the war and available to the authors up to the time of publication. Thoroughness of coverage of electronic terms is evidenced by inclusion of 75 entries for antennas, 65 for recording, 80 for electrons, 100 for frequency, 85 for grids, grates, and lattices, 40 for cathodes, 40 for capacitors, 45 for loudspeakers, 70 for direction finding, 150 for tubes, 120 for waves, etc. A patent-practice vocabulary is included, adding greatly to the value of this book in an engineer's library.—J.M.

Television Primer of Production and Direction

By LOUIS A. SPOSA. McGraw-Hill Book Co., Inc., New York, N. Y., 1947, 237 pages, \$3.50.

THOUGH dealing primarily with techniques of producing television programs, this little book contains much information of value to engineers and their assistants at television stations, as well as those concerned with the design and manufacture of cameras and other equipment used in television studios. The greater the familiarity of an engineer with the end uses of his product, the more useful and versatile will his product be.—J.M.

Writing the Technical Report

By J. RALEIGH NELSON, Professor Emeritus, University of Michigan, McGraw-Hill Book Co., New York, 1947, 388 pages, \$3.00.

ENGINEERS are judged not on what they know, but on the extent to which they clearly present their knowledge to company executives, clients, and other engineers. Frequently report writing is neglected because of pressure to learn additional technical material. The result, as editorialized recently in the British *Electronic Engineering*, is that excessive verbiage, ambig-

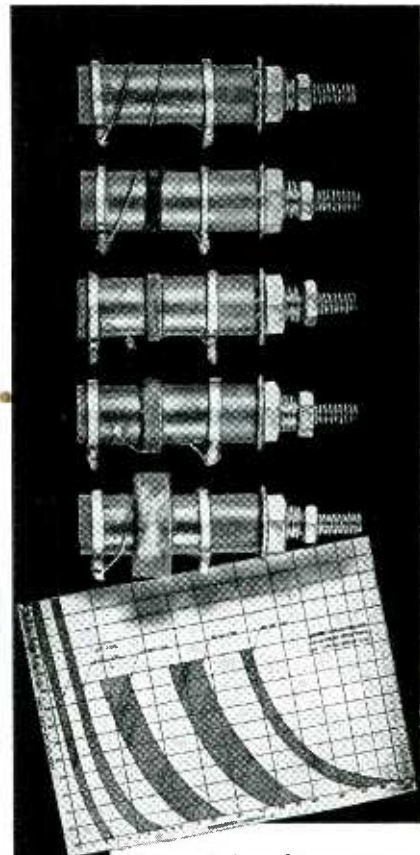

This graph shows frequency ranges covered by each unit. Write us for your full-size copy.

Five Standard Slug-Tuned LS3 Coils Cover ½ to 184 mc

For strip amplifier work, the compact (1½" high when mounted) LS3 Coil is ideal. Also for Filters, Oscillators, Wave-Traps or any purpose where an adjustable inductance is desired.

Five Standard Windings—1, 5, 10, 30 and 60 megacycle coils cover inductance ranges between 750 and 0.065 microhenries.

CTC LS3 Coils are easy to assemble, one ¼" hole is all you need. Each unit is durably varnished and supplied with required mounting hardware.

SPECIAL COILS

CTC will custom-engineer and produce coils of almost any size and style of winding...to the most particular manufacturer's specifications.



Consult CTC for Three-Way Component Service

Custom Engineering... Standardized Design...
Guaranteed Materials and Workmanship
CAMBRIDGE THERMIONIC CORPORATION
437 Concord Avenue, Cambridge 38, Mass.

uity, and vague expressions in reports are taken by readers to indicate lack of thought. The present book examines report organization and preparation, and describes good practices of style and format. An especially valuable feature is the criticism of typical reports. Suggestions for class use are included at the end, should the book be used in colleges.—F.R.

The Future of Television

BY ORRIN E. DUNLAP, JR. *Harper & Brothers, New York, N. Y., revised edition, 1947, 194 pages, \$3.00.*

REVISION of the 1942 edition brings it up to date and looks still farther ahead. The appendix now lists 150 historic steps in television from 1867 (Maxwell's wave theory) to 1947. Though dealing chiefly with economic and programming aspects, engineers will find here many answers to the kinds of television questions posed by nontechnical friends.—J.M.

Electronic Engineering Principles

BY JOHN D. RYDER, *Professor of Electrical Engineering, Iowa State College, Prentice-Hall, New York, 1947, 397 pages, \$6.65.*

WRITTEN to present electronics to all engineering students, this book embraces electronics, tubes and tube characteristics, and the most common amplifier, rectifier, and control circuits. Although intended for class-room use, the book is sufficiently clear and complete in itself to be read by those studying the subject alone.—F.R.

Vector and Tensor Analysis

BY LOUIS BRAND, *Professor of Mathematics, University of Cincinnati, John Wiley and Sons, New York, 1947, 439 pages, \$5.50.*

THE SUBJECT is presented in the form of assertions about the mathematical properties of vectors and tensors, thus giving a grounding in their characteristics and manipulation. However, the mathematical rigor is at times incomplete, and the application of the techniques to engineering is only sketchy, so that the book is more suited to college courses than personal study.—F.R.

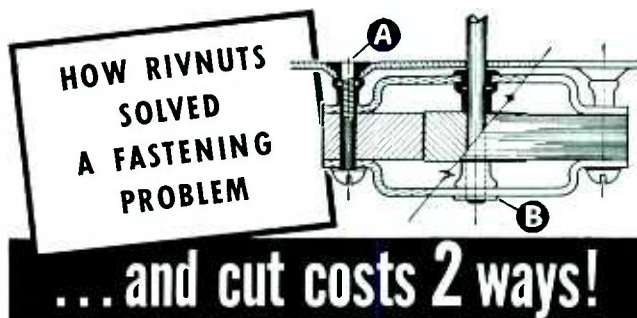

A MANUFACTURER wanted to make a new motor that would give good service—yet he wanted to produce it at minimum cost. B. F. Goodrich Rivnuts helped him solve the problem.

Rivnuts "A" provided deep nut plates for attachment screws. And their countersunk heads permitted the use of thinner sheet steel for the case.

Rivnuts "B", with threads drilled out, served as inexpensive bearings for the armature shaft.

In both cases, Rivnuts were installed from one side of the work with a simple heading tool. Many man hours were saved.

Rivnuts thus cut costs of the motor two ways: 1) lower material costs, and 2) reduced production time. If you have a fastening problem, why not put it up to Rivnut engineers? Write The B. F. Goodrich Company, Department E-97, Akron, Ohio.

NEW RIVNUT DATA BOOK GIVES FASTENING FACTS

New 40-page edition. Fully illustrated. Describes installation step-by-step. Gives types, sizes, load capacities. Tells where and how to use Rivnuts. For your free copy, write to



B. F. Goodrich DEPT. E-97, AKRON, OHIO

New . . . Improved

ATTENUATORS

by **TECH LABS**

Type 800

Type 900

TYPE 800 and 900

"New Times—New Modes", says old proverb. These new attenuators were born to meet new war-created demands. They represent a new medium frame size: Type 800 (2 1/4" dia.) and a larger size: Type 900 (3" dia.). The Type 800 is supplied as potentiometer, rheostat, ladder and T-pad up to 20 steps. The larger size Type 900 is similarly furnished with up to 45 steps. Write for new bulletin.

TECH
LABORATORIES, INC.®

Manufacturers of Precision Electrical Resistance Instruments
337 CENTRAL AVE. • JERSEY CITY 7, N. J.

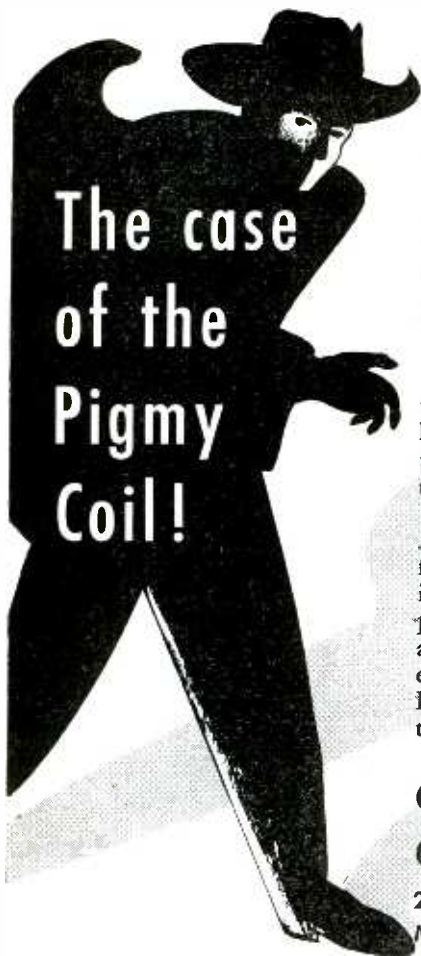

The case
of the
Pigmy
Coil!

A PROMINENT manufacturer re-designed his product for lower costs and better performance. But the new design called for a coil smaller than he had ever used before: Central Paper Company research engineers were consulted on the problem. They suggested reducing the bulk of the insulating paper used in winding coil. They developed an entirely new paper, thinner than any ever used for coil winding before, yet, because of its controlled and greatly reduced porosity, higher dielectric strength and anti-tarnish properties, the ideal paper for this particular application.

It is for solving problems like these . . . developing new and better papers for use in the electrical and many other industries . . . that Central Paper Company maintains one of the finest laboratories in the industry. Put this knowledge and experience to work for you. Bring your electrical paper problems to Central Paper Company.

**CENTRAL PAPER
COMPANY INC.**

2442 LAKESHORE DRIVE
MUSKEGON, MICHIGAN



REG. U. S.
PAT. OFF.

Backtalk

This department is operated as an open forum where our readers may discuss problems of the electronics industry or comment upon articles which **ELECTRONICS** has published.

Electrometer Addendum

Dear Sir:

THE TIME necessary for an electrometer tube to reach equilibrium can be substantially reduced if the supply voltages are applied only after the cathode has reached operating temperature. This could easily be accomplished in the amplifier described in my paper, published in the June 1947 issue of **ELECTRONICS** (p 138), if a double-pole time delay relay of 1-2 minutes delay were inserted into the screen and plate connections of the 12BE6 tube (Fig. 1).

H. S. ANKER

Department of Biochemistry
The University of Chicago
Chicago, Illinois

Reverberation Time Nomographs

Dear Sir:

IT IS pleasing to note Mr. R. C. Coile's attempt to reduce the computations involved in the acoustic treatment of rooms to a simple set of nomographs in his paper on Reverberation Time Nomographs in the April issue of **ELECTRONICS**.

The alert acoustical engineer will recognize immediately the limitations of the nomograph in Fig. 1 of Mr. Coile's paper. However, judging by the inquiries on the use of acoustic materials received at this Bureau, a novice might be led far astray by using the incomplete information in the nomograph.

First, in the absence of notes or textual reference to the contrary, it might appear offhand that any acoustic material has a unique coefficient of sound absorption at a given frequency. Actually, the coefficient depends very much on how the material is mounted. Published lists¹ show that the variation in sound absorbing power of the same material can vary by as much as

Quality you can see!

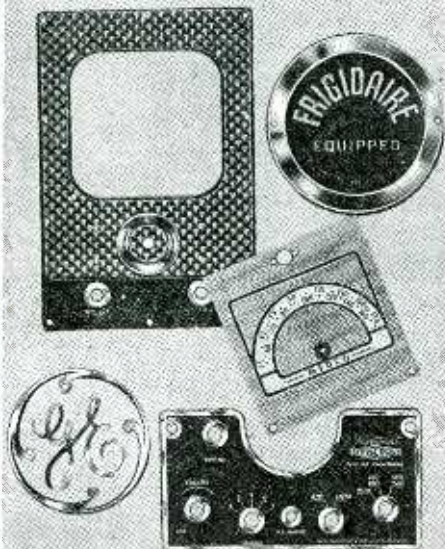

PREMIER DIALS, PANELS & PLATES

What counts, sales-wise, is what your customer sees. What gets the attention for Premier Metal Products, quality-wise, is their sharpness and clarity . . . close tolerances . . . rich colors and baked-in finishes. Let us tell you how these qualities can add important sales-appeal to your products.

Etched & Lithographed on:

- Aluminum
- Brass
- Bronze
- Copper
- Manel
- Nickel Silver
- Stainless Steel

WRITE FOR BULLETIN

PREMIER METAL ETCHING COMPANY

21-07 44TH AVENUE

LONG ISLAND CITY 1, N. Y.

Quality Products for Over 35 Years

100 percent for different methods of mounting. Consequently, the mounting information should be included in the nomograph along with the material. Otherwise, separate nomographs would have to be constructed for each type of mounting or for each material. Also, the inclusion of a numerical scale on the absorption coefficients scale might increase the usefulness of the nomograph.

Second, it might be inferred from the nomograph that the sound absorption coefficient is directly proportional to the area of an acoustic material. For larger areas, say greater than 60 or 70 square feet, this is approximately true. Occasionally, however, acoustic materials are applied in smaller patches. Experiments² show that the coefficient determined for small patches are appreciably greater than for larger areas.

PETER CHRZANOWSKI,
Physicist, Sound Section
National Bureau of Standards
Washington, D. C.

(1) "Sound Absorption Coefficients of the More Common Acoustic Material", Letter Circular published periodically by National Bureau of Standards, Washington, D. C.

"Sound Absorption Coefficients of Architectural Acoustical Materials", published periodically by Acoustical Materials Association, 205 West Monroe Street, Chicago, Ill.

(2) V. L. Chrisler, Dependence of Sound Absorption upon the Area and Distribution of the Absorbent Material, *Jour. Res. N. B. S.*, 13, p 169, 1934.

J. S. Parkinson, Area and Pattern Effects in the Measurement of Sound Absorption, *Jour. Acous. Soc. Am.*, 2, p 112, 1930.

Dear Sir:

DR. CHRZANOWSKI'S questions as to limitations in the use of the nomographs for Reverberation Time given in April ELECTRONICS are well taken. A precise calculation of reverberation time should include the method of mounting the acoustic material, the consideration of the size of the patch as well as its relation to the geometry of the room, the use of the proper acoustical coefficients for a particular frequency, the effect of humidity, and should more properly not use the approximate formula which the nomograph represents.

Surprisingly enough, however, the approximate values that the nomographs give are very close to practical measured values for average rooms such as are used in broadcast stations, offices, and homes.

R. C. COILE
Colton & Foss, Inc.
Washington, D. C.

MILFORD FASTENING EQUIPMENT

HAVE YOU ASSEMBLIES LIKE THESE?

Heating Equipment
Small Animal Cages
Industrial Baskets
Baby Carriages Stoves
Leather Goods, etc., etc.



Assemblies cost more than you think. Not the material, but the time to complete them. Check time costs and you will be startled. Milford knows — from checking time costs for innumerable manufacturers. That's why they chose Milford Fastening Equipment (semi-tubular or split rivets and rivet setters). It flattens the time-cost curve, assures proved and important savings on assemblies as diverse as wrist-watches and refrigerators. Don't delay. Investigate today. Deliveries are not yet normal. Earliest ordered, earliest delivered.

The Milford Rivet & Machine Co.
859 Bridgeport Avenue, Milford, Conn.
1002 West River Street, Elyria, Ohio

Inquiries may also be addressed to our subsidiary:
THE PENN RIVET & MACHINE CO., PHILADELPHIA 33, PENNA.

CB Model 245A . . . TR. C & R BRIDGE

For accurate determination of capacitance of condensers of all types, stray capacitance, resistance of composition and wire-wound resistors, conductivity of chemical solutions, turn ratio of transformers, load matching, miscellaneous leakage, etcetera.



VERSATILITY PLUS ACCURACY

CONSTRUCTION: Wire-wound resistors in all ranges, accurately processed and adjusted mica standard, ceramic insulating bushings in all leakage circuits, selective amplifier-indicator of high sensitivity, protective charging-current relay and many other features. Highest quality components used exclusively.

WRITE FOR CATALOG E9

The CLOUGH BRENGLE CO.
6014 Broadway Chicago 40, Ill.

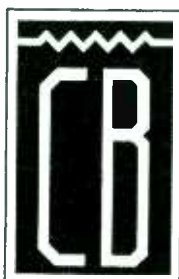

ADDITIONS and CORRECTIONS

to the

JUNE 1947-1948 ELECTRONICS DIRECTORY ISSUE

CONSULTING ENGINEERS

The following names of consultants were received after publication of a more extensive list in ELECTRONICS BUYERS' GUIDE for June 1947, Mid-Month issue, starting on page 132. Refer to the number key, printed on that page, for a breakdown of the specific Communications and Industrial services available. An asterisk following the name indicates that patents are handled as well.

ADDITIONS:—

Name	Commu- nications	Indus- trial	Design	Models	Area
BARONE CO. S. A. 143-5 West 22nd St., New York 11, N. Y. Arthur J. Odgers Leslie Norde	1-2-4-10- 12-17-20		•	•	international
BUILDER, G., ESQ.* 7 Appian Way, Burnwood, N. S. W., Australia		1	•	•	national
EDGERTON, GERMESHAUSEN & GRIER 77 Massachusetts Ave., Cambridge, Mass.		1-17- 22	•	•	national
ELLSWORTH, A. R. 8469 Hollywood Blvd., Hollywood, Calif.	15	15			
FERRAMENTA, M. Rua Joaquim Tavora 300. SERRAS Est De Sao Paulo, Brazil	1-2	1-2	•		statewide
HOLLEY, ARMANDO* Calle Constitucion 097, Santiago, Chile, S.A.	15	15	•		national
IVINS, H. Y. Box 82, Plymouth, Ind.	1		•		150 miles
LEATHAM, W. G. P. O. Box 11, Lower Hutt, N. Z.	1	1	•		national
LUNDY, CLARENCE 428 Boulevard, Bayonne, N. J.		5	•		
NIAGARA ELECTRON LABORATORIES Box 141, Andover, N. Y. P. M. Hackett	1-5-6 8-17		•	•	
PACENT ENGINEERING CORP.* 79 Madison Ave., New York 16, N. Y. L. G. Pacent Edward W. Noli	1-4-10-12 20-25- 30		•		national
PARDEE, H.* 549 W. Washington Blvd., Chicago, Ill.		20	•		national

Name	Commu- nications	Indus- trial	Design	Models	Area
PATRICK RESEARCH & DEVELOP- MENT LABS.* 5208 N. Keystone Ave., Indianapolis, Ind. E. Patrick		1-2		•	national
POLLACK, DALE 352 Pequot Ave., New London, Conn.	1-2-5-10 11-12-26		•	•	national
RADIO INVENTIONS, INC.* 155 Perry St., New York, N. Y.		5	•	•	national
RUBIN, H. B.* 1 Flint St., Poquonock Bridge, Conn.	20		•	•	1500 miles
SACAZES, J. M.* 35 Rue de la Dalbade, Toulouse, Haute Garonne, France	17			•	France
STEPHENS, HERBERT V. 63 Edsen St., Buffalo 10, N. Y.					
WHEELER LABORATORIES, INC. 259-09 Northern Blvd., Great Neck, N. Y. Harold A. Wheeler	5-10-11 12-19-25 26	5-8			national
WISE, ROGER 7 Grace Square, New York, N. Y.					
ZELINGER, GEZA P. O. Box 1239, Haifa, Palestine	10		•	•	statewide

CORRECTIONS:—

GALANTY, HAROLD
287 Conklin Ave., Hillside, N. J. (not N. Y.)

HAYNES, A.
2227 S. 10th Ave., Broadview, Maywood,
Ill. (not Mayview)

PRODUCT LISTINGS

The following listings are to be used in conjunction with the June 1947-1948 ELECTRONICS BUYERS' GUIDE for information on manufacturers' names, addresses, and products omitted or incorrectly listed in that issue. Product classification names are the same as used in the June Guide.

ADAPTERS—Battery

Eby, Inc., Hugh H., 18 W. Chelton Ave.,
Philadelphia 13, Pa.

ADHESIVES

Durez Plastics & Chemicals, Inc., 1921
Walck Rd., North Tonawanda, N. Y.

ADHESIVES—Waterproof & Corrosion Proof Compounds

Durez Plastics & Chemicals, Inc., 1921
Walck Rd., North Tonawanda, N. Y.

AMPLIFIERS—Audio Frequency

Kinsey Radio Engineering Co., Inc., 1208
Farnam St., Omaha 2, Nebraska
Northern Radio Co., Inc., 143-145 W.
22nd St., New York 11, N. Y.

ATTENUATORS

Daven Co., The, 191 Central Ave., Newark
4, N. J.

AMPLIFIERS—Audio Input Systems

Northern Radio Co., 143-145 W. 22nd St.,
New York 11, N. Y.

BATTERIES—Dry

Bowers Battery & Spark Plug Co., Read-
ing, Pa.
Burgess Battery Co., Battery Div., Free-
port, Ill.

BATTERIES—Standard Cell

Bowers Battery & Spark Plug Co., Read-
ing, Pa.

BATTERY CHARGERS

Bowers Battery & Spark Plug Co., Read-
ing, Pa.

BOXES—Metal

Paul & Beekman Div., Portable Products Corp., 1801 Cortland St., Philadelphia 40, Pa.

BUSHINGS—Nonmetallic

Franklin Fibre-Lamitex Corp., 12th & French Sts., Wilmington, Del.

CABINETS—Plastic

Norton Labs., Inc., Lockport, N. Y.

CAPACITORS—Variable Receiver Tuning

Airadio Inc., Melrose Ave. & Battery Pl., Stamford, Conn.

CEMENTS—Radio

Moyen, C. P., 908 Chicago Ave., Chicago, Ill.

COATINGS—Protective

Durez Plastics & Chemicals, Inc., 1921 Walck Rd., North Tonawanda, N. Y.
Sun Oil Co., 1608 Walnut St., Philadelphia 3, Pa.

CODE & TAB MARKERS

Smith Laboratories, Melvin L., 16 Field St., Kane, Pa.

COIL WINDING MACHINES

Seifert, Inc., E. R., 202 South Beach St., Syracuse, N. Y.

COMMUNICATION SYSTEMS—Facsimile

Northern Radio Co., Inc., 143-145 W. 22nd St., New York 11, N. Y.

COMMUNICATION SYSTEMS—Radio-teletype

Barker & Williamson, 235 Fairfield Ave., Upper Darby, Pa.

CONNECTORS—Cable Connectors & Couplings

Scintilla Magneto Div., Bendix Aviation Corp., Sidney, N. Y.

CONNECTORS—Coaxial Cable

Scintilla Magneto Div., Bendix Aviation Corp., Sidney, N. Y.

CONNECTORS—Receptacle

Scintilla Magneto Div., Bendix Aviation Corp., Sidney, N. Y.

CONTROLS—Temperature

Philadelphia Thermometer Co., 4401 N. Sixth St., Philadelphia, Pa.

CONVERTERS—Frequency Shift

Northern Radio Co., Inc., 143-145 W. 22nd St., New York 11, N. Y.

CRYSTAL HOLDERS

Smith Laboratories, Melvin L., 16 Field St., Kane, Pa.

CRYSTALS—i-f Filter

Bliley Electric Co., Union Station Bldg., Erie, Pa.

CRYSTALS—Quartz

Smith Laboratories, Melvin L., 16 Field St., Kane, Pa.

CRYSTALS—Receiver Control

Bliley Electric Co., Union Station Bldg., Erie, Pa.
Smith Laboratories, Melvin L., 16 Field St., Kane, Pa.

DIELECTRICS—Liquids & Solids

Sun Oil Co., 1608 Walnut St., Philadelphia 3, Pa.

DIES

Atlas Tool and Design Co., Castor & Kensington Avenues, Philadelphia 24, Pa.

DRAFTING EQUIPMENT

Ozalid Products Div., General-Aniline &

Film Corp., 770 Anseo Rd., Johnson City, N. Y.

ESUTCHEONS

Wilson Plastics Div., Wilson Magazine Camera Co., 6022 Media St., Philadelphia 31, Pa.

FILTERS—Electric Wave Section

Northern Radio Co., Inc., 143-145 W. 22nd St., New York 11, N. Y.

GENERATORS—Gas-Engine Driven

Burke Electric Co., 12th & Cranberry Sts., Erie, Pa.

GENERATORS—Hand Driven

Burke Electric Co., 12th & Cranberry Sts., Erie, Pa.

GRILLES—Molded Plastic

American Insulator Corp., New Freedom, Pa.
Norton Laboratories, Inc., Lockport, N. Y.

HEARING AIDS

Schulmerich Electronics, Inc., Sellersville, Pa.

HEATING, ELECTRONIC—Accessories and Associated Equipment

Sherman Industrial Electronics Co., Inc., 503 Washington Ave., Belleville 9, N. J.

HEATING, ELECTRONIC—Dielectric

Sherman Industrial Electronics Co., Inc., 503 Washington Ave., Belleville 9, N. J.

HEATING, ELECTRONIC—Induction

Sherman Industrial Electronics Co., Inc., 503 Washington Ave., Belleville 9, N. J.

INDICATORS—Temperature

Philadelphia Thermometer Co., 4401 N. Sixth St., Philadelphia, Pa.

INSTRUMENTS—Electronic Musical

Wurlitzer Mfg. Co., North Tonawanda, N. Y.

INSULATING COMPOUNDS**Impregnating Compounds**

Durez Plastics & Chemicals, Inc., 1921 Walck Rd., North Tonawanda, N. Y.
Sun Oil Co., 1608 Walnut St., Philadelphia 3, Pa.

Insulating Varnish

Durez Plastics & Chemicals, Inc., 1921 Walck Rd., North Tonawanda, N. Y.

Phenolic Molding Compounds

Durez Plastics & Chemicals, Inc., 1921 Walck Rd., North Tonawanda, N. Y.

Protective Sealers

Sun Oil Co., 1608 Walnut St., Philadelphia 3, Pa.

Resins

Durez Plastics & Chemicals, Inc., 1921 Walck Rd., North Tonawanda, N. Y.

Varnish Cambric Coatings

National Varnished Products Corp., 211 Randolph Ave., Woodbridge, N. J.

Waxes

Durez Plastics & Chemicals, Inc., 1921 Walck Rd., North Tonawanda, N. Y.
Sun Oil Co., 1608 Walnut St., Philadelphia 3, Pa.

INSULATION MATERIALS**Ceramic**

Scintilla Magneto Div., Bendix Aviation Corp., Sidney, N. Y.

Fabric

National Varnished Products Corp., 211 Randolph Ave., Woodbridge, N. J.

Paper

National Varnished Products Corp., 211 Randolph Ave., Woodbridge, N. J.

INSULATION PARTS**Ceramic Insulation Parts**

Scintilla Magneto Div., Bendix Aviation Corp., Sidney, N. Y.

Extruded Insulation Parts

National Varnished Products Corp., 211 Randolph Ave., Woodbridge, N. J.

Fabricated Insulation Parts

Accurate Mfg. Co., Inc., Philadelphia 32, Pa.
National Varnished Products Corp., 211 Randolph Ave., Woodbridge, N. J.
Norton Laboratories, Inc., Lockport, N. Y.

Molded Insulation Parts

American Insulator Corp., New Freedom, Pa.
Norton Laboratories, Inc., Lockport, N. Y.
Scintilla Magneto Div., Bendix Aviation Corp., Sidney, N. Y.

Plastic Insulation Parts

Accurate Mfg. Co., Inc., Philadelphia 32, Pa.
American Insulator Corp., New Freedom, Pa.
Norton Laboratories, Inc., Lockport, N. Y.

Rods

National Varnished Products Corp., 211 Randolph Ave., Woodbridge, N. J.

Stampings & Punchings—Paper

National Varnished Products Corp., 211 Randolph Ave., Woodbridge, N. J.

INSULATORS—Ceramic

Scintilla Magneto Div., Bendix Aviation Corp., Sidney, N. Y.

KEYERS & COUPLERS

Northern Radio Co., Inc., 143-145 W. 22nd St., New York 11, N. Y.

KNOBS—Plastic Molded

American Insulator Corp., New Freedom, Pa.
Norton Laboratories, Inc., Lockport, N. Y.

LIGHTS—Photoelectric Source

Eby, Inc., Hugh H., 18 W. Chelton Ave., Philadelphia 13, Pa.

LUGS AND TERMINALS

Lambert Mfg. Co., 639 West 12th St., Erie, Pa.

METAL PARTS—Powdered

Stackpole Carbon Co., St. Marys, Pa.

METAL PARTS—Small Metal Stampings

Accurate Mfg. Co., Inc., Philadelphia 32, Pa.
Atlas Tool and Design Co., Caster & Kensington Avenues, Philadelphia 24, Pa.
Lambert Mfg. Co., 639 West 12th St., Erie, Pa.

METALS**Brass and Bronze**

Phosphor Bronze Smelting Co., 2200 Washington Ave., Philadelphia 46, Pa.

Phosphor Bronze

Phosphor Bronze Smelting Co., 2200 Washington Ave., Philadelphia 46, Pa.

MONITORS—Frequency

Northern Radio Co., Inc., 143-145 West 22nd St., New York 11, N. Y.

(continued on next page)

(continued from preceding page)

MONITORS—(FS) Transmitter

Northern Radio Co., Inc., 143-145 West 22nd St., New York 11, N. Y.

MOTORS—Fractional hp

Marco Industries, Depew, N. Y.
Smith Laboratories, Melvin L., 16 Field St., Kane, Pa.

MOTORS—Phonograph

Marco Industries, Depew, N. Y.

MOTORS—Synchronous

Marco Industries, Depew, N. Y.

MOTORS—Timing

Marco Industries, Depew, N. Y.

MUSIC SYSTEMS—Industrial and Commercial

Schulmerich Electronics, Inc., Sellersville, Pa.
York Electric & Machine Co., Carillotone Div., 30-34 N. Penn St., York, Pa.

OSCILLATORS—Crystal

Smith Laboratories, Melvin L., 16 Field St., Kane, Pa.

OSCILLATORS—Radio Frequency

Northern Radio Co., Inc., 143-145 W. 22nd St., New York 11, N. Y.

OSCILLATORS—Ultrasonic

Barker & Williamson, 235 Fairfield Ave., Upper Darby, Pa.
Brush Development Co., 3405 Perkins Ave., Cleveland 14, Ohio
Fisher Scientific Co., 717 Forbes St., Pittsburgh 19, Pa.
General Electric Co., Schenectady 5, N. Y.
General Motors Co., Research Labs. Div., 485 W. Milwaukee Ave., Detroit, Mich.

PLASTIC MATERIALS

Phenol Formaldehyde—(Phenolics)

Durez Plastics & Chemicals, Inc., 1921 Walck Rd., North Tonawanda, N. Y.

Resins

Durez Plastics & Chemicals, Inc., 1921 Walck Rd., North Tonawanda, N. Y.

PLATES—Name

Wilson Plastics Div., Wilson Magazine Camera Co., 6022 Media St., Philadelphia 31, Pa.

POTENTIOMETERS

I-T-E Circuit Breaker Co., 19th & Hamilton Sts., Philadelphia 30, Pa.

POTS—Soldering

Trent Co., Harold E., Liverington Ave. at Wilde St., Philadelphia 27, Pa.

POWER SUPPLIES

National Radio Service Co., Reisterstown Rd. at Cold Spring Lane, Baltimore 15, Md.

POWER SUPPLIES—Electronically Regulated

National Radio Service Co., Reisterstown Rd. at Cold Spring Lane, Baltimore, 15, Md.

POWER SUPPLIES—Voltage Regulated

National Radio Service Co., Reisterstown Rd. at Cold Spring Lane, Baltimore, 15, Md.

RECEIVERS—*a-m* Fixed Frequency

Kinsey Radio Engineering Co., Inc., 1208 Farnam St., Omaha 27, Nebraska

RECEIVERS—Automobile

Kinsey Radio Engineering Co., Inc., 1208 Farnam St., Omaha 27, Nebraska

RECEIVERS—Diversity Reception

Northern Radio Co., Inc., 143-145 W. 22nd St., New York 11, N. Y.

RECEIVERS—Fixed Frequency

Kinsey Radio Engineering Co., Inc., 1208 Farnam St., Omaha 2, Nebraska

RECEIVERS—*f-m*

Kinsey Radio Engineering Co., Inc., 1208 Farnam St., Omaha 2, Nebraska

RECEIVERS, HOME—*a-m* Portables

Bowers Battery & Spark Plug Co., Reading, Pa.

RECEIVERS, HOME—*a-m* Table Models

Bowers Battery & Spark Plug Co., Reading, Pa.
Kinsey Radio Engineering Co., Inc., 1208 Farnam St., Omaha 2, Nebraska

RECEIVERS, HOME—*f-m* Table Models

Kinsey Radio Engineering Co., Inc., 1208 Farnam St., Omaha 2, Nebraska

RECORDERS—Sound and Phonograph

Presto Recording Corp., 242 West 55th St., New York, N. Y.

RELAYS—Mercury

Mack Electrical Devices Co., Elkins Park, Pa.

RESISTANCE SPECIALTIES

Shalleross Mfg. Co., 10 Jackson Ave., Collingdale, Pa.

RESISTORS—Fixed

I-T-E Circuit Breaker Co., 19th & Hamilton Sts., Philadelphia 30, Pa.

RESISTORS—Wire Wound

Stackpole Carbon Co., St. Marys, Pa.

RHEOSTATS

I-T-E Circuit Breaker Co., 19th & Hamilton Sts., Philadelphia 30, Pa.

RINGS—Oil Sealing

Stackpole Carbon Co., St. Marys, Pa.

SEALS—Carbon

Stackpole Carbon Co., St. Marys, Pa.

SOCKETS—Miniature Sockets & Connectors

Eby, Inc., Hugh H., 18 W. Chelton Ave., Philadelphia 13, Pa.

SOUND SYSTEMS—Complete

Schulmerich Electronics, Inc., Sellersville, Pa.
York Electric and Machine Co., Carillotone Div., 30-34 N. Penn St., York, Pa.

SWITCH PARTS

Contacts

Keystone Carbon Co., St. Marys, Pa.
Stackpole Carbon Co., St. Marys, Pa.

TOOLS—Screwdrivers and Small Insulated

Utica Drop Forge & Tool Corp., 2415 Whitesboro St., Utica 4, N. Y.

TRANSMITTERS—Aircraft

Supreme Transmitter Corp., 280 Ninth Ave., New York 1, N. Y.

TRANSMITTERS—Amateur

Supreme Transmitter Corp., 280 Ninth Ave., New York 1, N. Y.

TRANSMITTERS—*f-m*

Radio Engineering Labs, Inc., 35-54 36th St., Long Island City, N. Y.

TRANSMITTERS—Fixed Station Communication

Northern Radio Co., Inc., 143-145 W. 22nd St., New York 11, N. Y.

TRANSMITTERS—Marine

Supreme Transmitter Corp., 280 Ninth Ave., New York 1, N. Y.

TRANSMITTERS—Television

Du Mont Labs, Inc., Allen B., 2 Main Ave., Passaic, N. J.

TUBE PARTS

Anodes, Metallized Graphite

Stackpole Carbon Co., St. Marys, Pa.

TURNTABLES—Recording and Transcription

Gray Research & Development Co., 50 N. Central Ave., Elmsford, N. Y.

WASHERS—Insulating

Franklin Fibre-Lamitex Corp., 12th & French Sts., Wilmington, Del.

WIRE—Hookup

Precision Tube Co., 3828 Terrace St., Philadelphia 28, Pa.

NAME and ADDRESS ADDITIONS and CORRECTIONS

Accurate Mfg. Co., Inc., Philadelphia 32, Pa.

American Insulator Corp., New Freedom, Pa.

Atlas Tool and Design Co., Caster & Kensington Avenues, Philadelphia 24, Pa.

Bowers Battery & Spark Plug Co., Reading, Pa.

Burgess Battery Co., Battery Div., Freeport, Ill.

Durez Plastics & Chemicals, Inc., 1921 Walck Rd., North Tonawanda, N. Y.

Electro-Physical Laboratories, Inc., 290-8 Dyckman St., New York 34, N. Y.

General Motors Co., Research Labs. Div., 485 W. Milwaukee Ave., Detroit, Mich.

Guardian Electric Mfg. Co., 1621 West Walnut St., Chicago 12, Ill.

Instrument Electronics, 42-17A Douglaston Parkway, Douglaston, L. I., N. Y.

Kinsey Radio Engineering Co., Inc., 1208 Farnam St., Omaha 27, Nebraska

Lambert Mfg. Co., 639 West 12th St., Erie, Pa.

Mack Electrical Devices Co., Elkins Park, Pa.

Marco Industries, Depew, N. Y.

Moyen, C. P., 908 Chicago Ave., Chicago, Ill.

National Radio Service Co., Reisterstown Rd. at Cold Spring Lane, Baltimore 15, Md.

Northern Radio Co., Inc., 143-145 W. 22nd St., New York 11, N. Y.

Norton Laboratories, Inc., Lockport, N. Y.

Ozalid Products Div., General Aniline & Film Corp., 770 Ansoo Rd., Johnson City, N. Y.

Paragon Electric Co., Two Rivers, Wisconsin

Philadelphia Thermometer Co., 4401 N. Sixth St., Philadelphia, Pa.

Phosphor Bronze Smelting Co., 2200 Washington Ave., Philadelphia 46, Pa.

Ripley Co., Inc., P. O. Box 31, Middletown, Conn.

Schulmerich Electronics, Inc., Sellersville, Pa.

Scintilla Magneto Div., Bendix Aviation Corp., Sidney, N. Y.

Seifert, Inc., E. R., 202 South Beech St., Syracuse, N. Y.

Sherman Industrial Electronics Co., Inc., 503 Washington Ave., Belleville 9, N. J.

Simpson Mfg. Co., Inc., Mark, 32-28 49th St., Long Island City 3, N. Y.

Smith Laboratories, Melvin L., 16 Field St., Kane, Pa.

Sun Oil Co., 1608 Walnut St., Philadelphia 3, Pa.

Supreme Transmitter Corp., 280 Ninth Ave., New York 1, N. Y.

Trent Co., Harold E., Liverington Ave. at Wilde St., Philadelphia 27, Pa.

Utica Drop Forge & Tool Corp., 2415 Whitesboro St., Utica 4, N. Y.

Wurlitzer Mfg. Co., North Tonawanda, N. Y.

York Electric & Machine Co., Carillotone Div., 30-34 N. Penn St., York, Pa.

CONTACTS

FOR THE FIELD OF ELECTRONICS

FLUXES
SODERING
BRAZING & WELDING
L. B. ALLEN CO., INC. Chicago 31, Ill.
6751 Bryn Mawr Ave.

Prompt Deliveries Specializing in
High Voltage Filament and Plate
Transformers for Electronic Projects

ELECTRO ENGINEERING WORKS
6021 COLLEGE AVENUE • OAKLAND 11, CALIFORNIA

**FINE RIBBONS
OF
TUNGSTEN and MOLYBDENUM**
Quality and accuracy in our fabrication of Tungsten & Molybdenum Ribbons have characterized our service to the Electronic industry.
A development of
H. CROSS Co.
15 Beekman St., New York 7, N.Y.

Kahle

ELECTRON TUBE MACHINERY OF ALL TYPES
STANDARD AND SPECIAL DESIGN

We specialize in Equipment and Methods for the Manufacture of

**RADIO TUBES
CATHODE RAY TUBES
FLUORESCENT LAMPS
INCANDESCENT LAMPS
NEON TUBES
PHOTO CELLS
X-RAY TUBES
GLASS PRODUCTS**

Production or Laboratory Basis

Kahle ENGINEERING CO.
1309 SEVENTH STREET
NORTH BERGEN, N. J., U. S. A.

WE manufacture a complete line of equipment

SPOT WELDERS, electric from ¼ to 50 KVA
TRANSFORMERS, special and standard types
INCANDESCENT LAMP manufacturing equipment
ELECTRONIC TUBE MAKING EQUIPMENT
ELECTRONIC EQUIPMENT, vacuum pumps, etc.
WET GLASS SLICING and cutting machines for laboratory use
GENERAL GLASS working machines and burners
COLLEGE GLASS working units for students and laboratory

EISLER ENGINEERING CO.
731 So. 13th St. (near Avon Ave.) Newark, New Jersey

AC ARC WELDERS
from 100 to 400 Amps

One inexpensive modern device . . .

can frequently help speed up operation and maintenance or production.

One product advertised in the "Contacts" Section may be the answer to your problem . . . a real money-saver.

To be informed—and reminded—on modern aids to economical operation, maintenance and production, check "Contacts" advertising regularly . . . every issue.

MICROMETER FREQUENCY METER

for Checking Transmitters
from 100 Kc to 175 Mc.
within 0.01 per cent

LAMPKIN LABORATORIES
Bradenton, Fla., U. S. A.

BALL BEARINGS

MPB makes more than **40** different types and sizes . . .

For precision instruments, laboratory equipment, electronic devices, to minimize friction, space, weight, and to overcome starting torque specify MPB bearings.
Radial · Pivot · Angular Contact · Thrust
Promptly Available · Ask for catalog EL-23

MPB MINIATURE Precision BEARINGS
INCORPORATED
KEENE, NEW HAMPSHIRE, U.S.A.

ELECTRONIC EQUIPMENT
Custom Built for Your Job
BUCK ENGINEERING CO. Inc.
37 Marcy St. FREEHOLD, N. J.

When you're in need of some product or service to speed and improve operation, or save money, you may find it here—in the Where To Buy Section. It pays to check this page . . . each issue.

RADIO KNOBS IMMEDIATE DELIVERY

No. 1100 No. 1105 No. 1109
No. 1110

LARGE QUANTITIES for Manufacturers
Now available—variety of bakelite knobs in large quantities—set screw, knurl, or spring type—write for samples and quotations.

Write today for catalog of 3,000 electronic products.

GENERAL CEMENT MFG. CO.
Rockford, Illinois, U. S. A.

FILMGRAPH PAT'D
Conference Recorders

UNINTERRUPTED Longtime (up to 12 hours) Conference & Telephone Recordings on Safety Film Models for Dictation "TALKIES"

ECONOMICAL PERMANENT INSTANTANEOUS PLAY-BACK

MILES REPRODUCER CO., INC. 912 BROADWAY, N.Y. 3

High Speed Production Of Quality R. F. Coils and Sub-Assemblies, For Discriminating Manufacturers

Clippard INSTRUMENT LABORATORY, INC.
1125 Bank Street, Cincinnati 14, Ohio

PROFESSIONAL SERVICES

Consulting — Patents — Design — Development — Measurements

in

Radio, Audio, Industrial Electronic Applications

THE APPLIED SCIENCE CORPORATION OF PRINCETON

Applied Physics, Mathematics and Electronics
Design Industrial Applications Engineering
Research Development Consultation
Specialist in Radio Telemetry
P.O. Box #44, Princeton, N. J.
Phone: Lawrenceville, N. J. 430
Office & Laboratory: U. S. Highway #1, RD #4,
Trenton, New Jersey

PAUL E. GERST & CO.

CONSULTING ENGINEERS

Specialists in
Electrical Product Design
El. Machinery Apparatus & Applications
El. Appliances, Hi-Frequencies Apparatus
Electronics, Radio Communications
205 W. Wacker Dr. Chicago 6, Ill.

Eugene Mittelman, E.E., Ph.D.

Consulting Engineer & Physicist

High Frequency Heating — Industrial Electronics
Applied Physics and Mathematics
549 W. Washington Blvd. Chicago 6, Ill.
State 8021

H. RUSSELL BROWNELL

Consulting Engineer

Specializing in Measurements & Testing
Instruments & Techniques - Electrical - Elec-
tronic - Magnetic.
188 West 4th St. New York 14, N. Y.
Chelsea 2-4208

HANSON-GORRILL-BRIAN INC.

Product & Mfg. Development

ELECTRICAL - ELECTRONIC
HYDRAULIC - MECHANICAL
Meadow Lane Glen Cove, N. Y.
Glen Cove 1922

ALBERT PREISMAN

Consulting Engineer

Television, pulse Techniques, Video
Amplifiers, Phasing Networks,
Industrial Applications
Affiliated with
MANAGEMENT-TRAINING ASSOCIATES
3308-14th St., N.W. Washington 10, D. C.

CONTROLS LABORATORIES, INC.

Consulting Division

EXCEPTIONAL FACILITIES
for
RESEARCH and DEVELOPMENT
Electrical and Mechanical Problems
SPECIAL PATENT SITUATIONS
Background of over 200 research projects.
Partial list of subjects available upon request
98 Union St. Worcester 8, Mass.

MEASUREMENT ENGINEERING LIMITED

Consultants on Special Equipment for
measurements and production tests, com-
munications and audio systems.
61 Duke St. Toronto Canada

JOSEPH RAZEK, Ph. D.

Consulting Physicist

Electric and Mechanical Engineering Problems
Instruments and Control Devices Electronics
Specialists in Colorimetry, Spectrophotometry and
Industrial Color Control
Laboratory and Shop Facilities
202 Darby Road. Llanerch, Pa.
Phone Hilltop 6910

ELECTRONIC ENGINEERING CO. of CALIFORNIA

Radio and Electronic Consulting and
Designing.

2008 W. Seventh St. Los Angeles
DRexel 8323 California

WINFIELD SCOTT McCACHREN

AND ASSOCIATES

Consulting Radio Engineers

TELEVISION SPECIALISTS

Philadelphia: 809B Windemere Ave. 410 Bond Building
Drexel Hill, Pa. Washington, D. C.
Sunset 2537-W District 6923

ARTHUR J. SANIAL

Consulting Engineer

Loudspeaker Design; Development; Mfg. Processes.
High Quality Audio Systems, Announcing Systems.
Test and Measuring Equipment Design.
168-14 32 Ave. Flushing 9-3574 Flushing, N. Y.

ELM LABORATORIES

ELECTRONIC-MECHANICAL

RESEARCH & DESIGN

Patented ELM Developments include
PREGRAME Automatic Radio, Program Tuner,
Famous "Gerty" Direction Finder Loop, Sealed
Xtal Holder, Home Receiver Designs.
20 South Broadway Dobbs Ferry, New York
Phone Dobbs Ferry 4058

WILLIAM R. MEREDITH

B.A., B.SC., P.ENG. MEIC.

Barrister-at-Law

Consultant on Canadian
PATENTS, TRADE MARKS and COPYRIGHTS
National Building Ottawa, Canada
Telephone 2-9584

YARDENY ENGINEERING CO.

Remote Controls (Wires and Wireless)
Automatic Devices

Electronic • Electrical • Mechanical
Consultation • Designing • Manufacturing
Licensing

105 Chambers Street New York, N. Y.
Worth 2-3534, 3535

SEARCHLIGHT SECTION

EMPLOYMENT • BUSINESS • OPPORTUNITIES • EQUIPMENT — USED or RESALE

POSITIONS VACANT

TEACHERS OF electrical engineering at State
Land Grant College. Salaries \$3,000 to
\$4,200 for nine months. Both electronics and
power men. Write, giving complete personal
data and references to box P-1249, Electron-
ics, 520 N. Michigan Ave., Chicago 11, Ill.

WANTED BY leading West Coast manufac-
turer experienced sonar design engineer for
important military and commercial work.
Should be capable of handling complete de-
sign from development to production. Please
include full particulars and salary require-
ments in first letter. P-1390, Electronics,
68 Post Street, San Francisco 4, Cal.

ENGINEERS—RESEARCH and Development
Project Engineers with experience in de-
velopment wanted by medium sized nationally
known manufacturing concern in New Eng-
land. Attractive salary to those who qualify.
Write giving details and experience. P-1552,
Electronics, 330 W. 42nd St., New York 18,
N. Y.

POSITIONS VACANT

GRADUATE PHYSICIST or Electrical Engin-
eer for product development work with
manufacturer of electroacoustic and elec-
tromechanical devices. Please write stating
education, experience, and salary. P-1565,
Electronics, 520 N. Michigan Ave., Chicago 11,
Ill.

WANTED: TOP-flight physicist or electronic
engineer. Should have Ph.D or equivalent
experience. Must be capable of heading up
large development projects as well as of per-
forming original theoretical and experimental
research. Congenial working atmosphere
amongst many former M.I.T. Radiation
Laboratory personnel. Will pay any salary
commensurate with experience and ability.
Write Laboratory for Electronics, Inc., At-
t: Sims McGrath, 610 Newbury Street, Boston
15, Mass.

(Continued on opposite page)

RADIO DRAFTSMAN

DESIGNER & METHODS MEN required for
component parts manufacturer in Chicago.
Reply in full giving training, experience,
age and salaries.

P-1519, Electronics
520 North Michigan Ave., Chicago 11, Ill.

Additional
Positions Vacant
Advertisements
on the opposite page

SEARCHLIGHT SECTION

EMPLOYMENT • BUSINESS • OPPORTUNITIES • EQUIPMENT—USED or RESALE

UNDISPLAYED RATE:
90c a line, minimum 4 lines to figure advance payment count 6 average words as a line.
POSITIONS WANTED (full or part-time salaried individual employment only), 1/2 above rates.
PROPOSALS 75 cents a line an insertion.

INFORMATION:
BOX NUMBERS in care of any of our New York, Chicago or San Francisco offices count 10 words additional in undisplayed ads.
DISCOUNT of 10% if full payment is made in advance for four consecutive insertions of undisplayed ads (not including proposals).

DISPLAYED—RATE PER INCH
The advertising rate is \$9.00 per inch for all advertising appearing on other than a contract basis. Contract rates quoted on request.
AN ADVERTISING INCH is measured 7/8 inch vertically on one column, 3 columns—30 inches—to a page. E

NEW ADVERTISEMENTS received by 10 A.M. September 5th will appear in the September issue, subject to limitation of space available.

POSITIONS VACANT (Continued from opposite page)

YOUNG, GROWING, Eastern company performing development and research in the general field of electronics has several openings available for electronic engineers or physicists. At least two years experience in experimental work required. P-1355, Electronics, 330 W. 42nd St., New York 18, N. Y.
RESEARCH ENGINEER—For basic microwave research project. Master's degree in physics or EE or equivalent and several years experience required. Location N. Y. C. Give full details of training and experience and expected salary range. P-1622, Electronics, 330 W. 42nd St., New York 18, N. Y.

EMPLOYMENT SERVICES

SALARIED POSITIONS \$2,500-\$25,000. This thoroughly organized confidential service of 37 years recognized standing and reputation carries on preliminary negotiations for supervisory, technical and executive positions of the calibre indicated, through a procedure individualized to each client's requirements. Retaining fee protected by refund provision. Identity covered and present position protected. Send only name and address for details. R. W. Bixby, Inc., 260 Dun Bldg., Buffalo, N. Y.

EXECUTIVES \$3,000-\$25,000. This reliable service, established 1927, is geared to needs of high grade men who seek a change of connection under conditions assuring, if employed, full protection to present position. Send name and address only for details. Personal consultation invited. Jira Thayer Jennings, Dept. E, 109 Church Street, New Haven, Conn.

POSITIONS WANTED

JUNIOR ELECTRONIC'S Engineer available. BSSE Univ. of Michigan, June 1947. Single, age 23. Lieutenant Army Signal Corps, 38 months service. Desire position with progressive medium-size electronics concern. Locate anywhere in U. S. Jerome D. Moskowitz, Accord, Mass.

DUTCH ENGINEER, 3 years experience in Radar, Radio and Communication techniques, desires position in radar, television, or electronics navigational systems. Letter, Wielders, Wijermanstraat, Wassenaar, Holland.

ULTRASONIC DEVELOPMENT Engineer, 18 years experience B.S.E.E., specialist in instrument design. Seeks further opportunity B. R. Schofield, 4046 North LaPorte Ave., Chicago 41, Ill.

ADVERTISING MAN With Technical Background and Experience AVAILABLE

to take charge of, or assist with, advertising program for manufacturer or merchandiser of electronic equipment, located in New York or Northern New Jersey.

Can handle all phases of sales promotion, publicity, dealer training, public relations, instruction manuals. Familiar with production, art, photography, and copy.

PW-1559, Electronics
330 West 42nd St., New York 18, N. Y.

Don't forget the

BOX NUMBER

When answering the classified advertisements in this magazine don't forget to put the box number on your envelope. It is our only means of identifying the advertisement you are answering.

ENGINEERS NEEDED

Large Eastern manufacturer of communication and broadcast radio equipment has positions available for the following personnel:

Broadcast Receiver Project Engineers and Assistant Project Engineers

Television Receiver Project Engineers and Assistant Project Engineers

Mechanical Engineers — Senior Draftsmen Detail Draftsmen

Personnel experienced in design methods on broadcast, television and automobile radio receivers preferred. Pleasant working conditions. Unlimited advancement opportunities. Reply in detail, giving complete resume of business experience.

P-1568, Electronics
520 North Michigan Ave., Chicago 11, Ill.

POSITIONS WANTED

ENGINEER-PHYSICIST, 40, with B.S. and M.S. degrees in E.E. and a Ph.D. degree in Physics seeks development engineering position or one in teaching. Has fourteen years' industrial experience from employments with Westinghouse, Philco, Panama Canal, and General Electric in design, development, and application of electrical power and electronic equipment; and over five years' experience teaching E.E., Radio and Electronics in day and evening schools. PW-351, Electronics, 330 W. 42nd St., New York 18, N. Y.

ELECTRICAL ENGINEER, age 30, four years experience as patent agent, three years experience in development of automatic telephone systems, thorough knowledge of electronics. Desire position as development or sales engineer. PW-1488, Electronics, 520 N. Michigan Ave., Chicago 11, Ill.

ELECTRONICS RESEARCH, three years Army radar technical officer, graduate Harvard and MIT wartime radar school, B.A. degree (Physics), background of radio servicing, good understanding of mechanical drawing, practical mechanics and machine shop. Wish position in electronic research or development. PW-1583, Electronics, 520 N. Michigan Ave., Chicago 11, Ill.

SERVO-MECHANISMS AND INSTRUMENTATION Engineer M.S. and B.S., M.I.T. Six years' experience in the industrial and service design and development of servos, gyros, computers, indicators, and precision electronic and electro-mechanical systems. PW-1596, Electronics, 330 W. 42nd St., New York 18, N. Y.

ELECTRICAL ENG. graduate 14 years experience radio field position in service development instruction. PW-1576, Electronics, 330 W. 42nd St., New York 18, N. Y.

SELLING OPPORTUNITY WANTED

SALES-ELECTRICAL Engineer '38. 10 years diversified electronic and electrical experience. Self starter. Constructive thinking. Intimately acquainted with key personnel in engineering activities of Army, Navy, Air Force and private industry. Thoroughly familiar with all purchasing and contracting procedures. Commission only. Minimum draw \$7500. SA-1584, Electronics, 330 W. 42nd St., New York 18, N. Y.

(Additional Selling & Business Opportunity ads on page 272.)

CONSULTANT ENGINEER CARBON RESISTOR EXPERT

Must be thoroughly familiar with all phases of the manufacture of fixed type carbon resistors. On consultant basis, will be expected to recommend and obtain machinery; plan; estimate; and follow up on a plant installation abroad.

P-1410, Electronics,
330 West 42nd St., New York 18, N. Y.

RADIO RECEIVER ENGINEER

Junior or Senior, experience with component parts including Permeability Tuners Desirable. Location Chicago. Excellent opportunity and security. Reply in confidence giving training, experience, age, and salaries.

P-1518, Electronics
520 North Michigan Ave., Chicago 11, Ill.

WANTED ELECTRONIC ENGINEER

Leading manufacturer of electronic and therapeutic equipment in the Northern New Jersey area requires the services of an engineer with several years experience in Mercury vapor lamps. In reply, give education, experience, and salary expected.

P-1232, Electronics
330 West 42nd St., New York 18, N. Y.

WANTED ELECTRONIC ENGINEER

For supervisory job in Florida. Practical experience marine RT, supersonic depth sounding, radar v.h.f. communications, and sales. Salary commensurate with ability. Reply

P-1512, Electronics
330 West 42nd St., New York 18, N. Y.

BELGIUM

American Firms desirous to extend their activity
to Belgium, are invited to contact with

SOCIETE INDUSTRIELLE ALFA

80, rue de la Senne

BRUSSELS

*Oldest importer of American radio, electrical and
electronic material.*

FOR SALE

Eastern transformer plant. Well equipped—fully staffed—good business. All types of power transformers up to 5 KVA, chokes and audio. Special apparatus transformers our specialty. Plant capacity \$75,000. monthly. This is not a sacrifice sale—asking no good will, net worth only. If you want to manufacture transformers or if you are a large user this is worth investigating.

BO-1257, Electronics,
330 West 42nd St., New York 18, N. Y.

2 KW MODULATION TRANSFORMERS — COLLINS

12000 to 4000 ohms

NEW IN ORIGINAL CRATES

\$25.00 each

WESTERN ENGINEERS, Ltd.
Box 1111, Oakland, CALIFORNIA

Sweep Calibrators

Designed by

Radiation Laboratory M. I. T.

Model B—The instrument provides calibration marks for use in calibrating the sweep speed of a synchroscope or triggered sweep oscilloscope. The markers consist of short video pulses, of less than 1/2 microsecond duration, spaced apart by a known number of microseconds.

SPECIFICATION—Ranges—Switch permits choice of 4 different time intervals between calibration markers: 2.5—10—50—100 microseconds. Operating voltage 110 to 120v. 60 cycle. Power consumption 85 watts; weight 23 lbs. Size 8"x16"x7 7/8". **\$89.50**

Model A—This instrument is intended for calibrating the sweep speed of a synchroscope or a triggered oscilloscope. The output consists of a train of sine-wave oscillations of known frequency.

FREQUENCY RANGE: Available by use of Panel switch.

Frequency	Microseconds per cycle
200 KC	5
1 MC	1
5 MC	0.2

Operating voltage 110 to 120v. 60 cycle. Power consumption 100 watts. Weight 19 lbs. Size 8"x16"x7 7/8". **\$59.50**
BRAND NEW

CLARK-REISS DISTRIBUTORS, INC.

55 WALKER ST., NEW YORK 13, N. Y.

Telephone CAAnal 6-7485

TEST EQUIPMENT

General Radio, Measurements, Ferris Etc., used, 20 to 60 percent off. Surplus Selsyn Generators, Etc.

VILLAGE RADIO EQUIPMENT

201 West 16 Street New York City

MICROWAVES

Surplus test equipment and misc. components for microwave frequencies. A few of the 3 centimeter components are listed below. All are new, silver-plated and are standard lab. test components in 1 1/4" wavelength. Choke-flange connectors are standard square type.

726A/B tube mount; type "N" output.....	\$6.00
Bulkhead Connector; 4 In. Long.....	5.00
90° Elbow; E Plane; 1 1/2" Radius; 4 In.....	5.00
90° Elbow; H Plane; 1 1/2" Radius; 4 In.....	5.00
90° Twist; 6 Inches Long.....	7.00
45° Twist; 6 Inches Long.....	5.00
Pressurized Unit; 4" Long; Valve & Meter...	9.00
Crystal Mount; Broad-banded; VSWR 1.1 max. over 8500 to 9400 megacycles.....	20.00
Directional coupler; 21 Db.; 8 in. long Part of AN/CPN-6; Govt. Inspected.....	20.00
Waveguide conn.; Flange; UG-39/U 12 for	5.00
Waveguide conn.; Choke; UG-40/U 12 for	7.00
Straight section; 80 in.; silver plated; with UG-39 flange-UG40 Choke conns.....	7.00
Flexible waveguide; 9"; gold-plated; rubber covered; UG-39/U flange conns.....	4.50
Duplexer unit; coupling for TR; ATR is attached; flex. waveguide in and out.....	6.00
Straight sections; 6" long; may be obtained with any comb. of connectors.....	4.50
Waveguide; RG-52/U; 1/2"x1; 10 ft. lengths; per foot	.50
Waveguide; RG-51U; 3/4"x1 1/4"; 10 ft. lengths; per foot	.60
Connectors; UG-21; UG-22; UG-24; UG-27; UG-30; UG-58; UG-105; UG-102; each...	.75

ALSO AVAILABLE: Slotted lines, terminations signal generators, tubes, adapters, attenuators "T" sections; rotating joints, wavemeters, tube mounts, magnets, thermistor mounts, etc.
10 CENTIMETER: All test components; rigid coaxial lines; waveguides; tubes; antennas.

MICROWAVE EQUIPMENT CO.

57 Elmwood Rd. Verona, N. J.

All merchandise guaranteed. All prices F.O.B. Verona, N. J. Send Money Order or Check. Orders accepted from rated concerns on open account net 10 days. Send for catalog and supplementary lists. New material each week.

RADIO TOWER

Self supporting—60 feet high. 3 foot wide platform around top with 3 foot high handrail.

Center pipe supports for 2" pipe for adjustable support of FM and television antennae.

Unassembled—has never been installed. Perfect condition. Price subject to agreement on inspection at Indianapolis.

Phone, Write or Wire

W. J. TOPMILLER,

P. R. MALLORY & CO., INC.

Indianapolis 6, Indiana

MICRO WAVE ANTENNA

New APG-15B Antennas. 10 Cm. Antenna in Radome. Original factory crates. Quantity prices on request.

SERVO-TEK PRODUCTS CO.

247 Crooks Ave. Clifton, N. J.

WESTINGHOUSE 861 TUBES

New—Guaranteed—Sealed Cartons

\$9.00 Each

WESTERN ELECTRONIC CO.

2797 Shattuck Ave. Berkeley, California

WANTED

Western Electric
D93306 Vertical Reproducers

Any Condition

Send particulars to

P.O. Box 82, Floral Park L. I. N. Y.

Surplus TANTALUM

FOR SALE

Sheets .004 & .006 \$83 per kg.
Ribbon .070 to .015 83 per kg.
Wire .008 to .012 95 per kg.

Manufactured by Fansteel Met.
Write for our stock list now while we still have a complete inventory.

J. M. HIRSCH CO.

622 Washington St., San Francisco 11

TWO RA-38 HIGH VOLTAGE RECTIFIERS

15,000 volt, .5 Amp. output; 115 volt, 60 cycle, single phase input. Gov. surplus. Original cost; \$15,000 ea. \$275. ea. F.O.B. Chicago.

U. S. PLASTICS CORPORATION

2853 W. Irving Park Road, Chicago 18, Illinois.

GENERAL ELECTRIC PYRANOL CAPACITORS

Catalogue #18F168. MU-FI20 Y38894
3,000 volt max. DC

FINK & OLSWANG

Chicago 6, Illinois
27 S. Desplaines St.,

FOR SALE

300 FT.
DOUBLE BRAIDED SHIELD
8 CONDUCTOR CABLE

Best Offer

FINCH TELECOMMUNICATIONS, INC.
PASSAIC, N. J.

METERS

SPECIAL TYPES

Marion "S" meter, made for National Co., 1 MA mvt. sc. cal 1-9 units S and 0-40 DB above S 9, 2" ring mtd fl metal case. @ \$3.50

Simpson, 25, Signal Strength ("S") Meter, 3 1/2", rd fl bake case. Use this on the plate circuit of your receiver to show the relative strength of incoming signals. Sc calibrated—6 to 100 DB above 1 microvolt, 5 MA Zero right mvt with translucent sc, for internal sc illumination from rear of meter. Comp with socket, lamp and leads. For further details refer to pages 164-165 & Fig. 730 B of Radio Amateur's Handbook. @ \$4.50

Weston 301, type 21 Standard Decibel Meter, 3 1/2", rd fl bake case, minus 10 to plus 6 MW, 500 ohms; General purpose type 0.5-0.7 Second to final reading, 45-62% overthrow, 5000 ohms internal resistance at ODB. @ \$8.50

J.B.T., 30-F, Dual range Frequency Meter Covers Frequency ranges from 48 to 52 cycles and 58-62 cycles; Dual element, Vibrating Reed type, 115 volt, 3 1/2", rd flush metal case. @ \$5.95

Voltage Polarity Phase Rotation Tester, Triplett 337 AVP, Checks 115, 220 and 440 line voltage; locates open circuits, blown fuses, damaged wiring, etc.; Indicates whether A.C. or D.C. and polarity of D.C.; Checks phase rotation to determine direction of rotation of motors, operation of controls, etc.; Consists of a 3" square meter and a small polarized vane movement in a small handy sized case. Complete with 36" leads with test prods. @ \$8.50

G.E., SKT8, Running Time Meter, 115 volt, 60 cycle, totals up to 99,999 hrs. Gray sc, 3", sq fl bake case. @ \$4.95

J.B.T. 3 1/2", Frequency Meter, 58-62 cycle, 5 feed, 100-150 volts. @ \$4.50

Time Totalizer Indicates up to 9,999.9 hours for 50 or 60 cycle operation on 105 to 130 volts. Black scale 3" rd fl bakelite case, clamp mounted, Made by Industrial Timer Corp. @ \$4.00

W.H. DB Meter RC-35 —10 +6 ODB—1.897 V, 6 MW—600 ohms 3" square. @ \$4.50

D.C. VOLTMETERS

Weston 301, 500 V D.C. 1000 r/v 3 1/2" rd fl bake case. @ \$9.50

Weston 301, 5 KV, Complete with 1000 ohms per volt ext prec wire wound resistor & mtg clips, 3 1/2", rd fl bake case. @ \$9.95

W.E., 75 V, 1000 ohms per volt, 3 1/2", rd fl bake case, concentric style. @ \$3.00

W.H., NX-35, 50 V, 200 ohms per volt, 3 1/2", rd fl bake case. @ \$3.95

W.H., NX-35, 200 V, 200 ohms per volt, mounted on 45° metal angle panel with binding posts. @ \$4.95

W.H., NX-35, 750 V, 1000 ohms per volt, 3 1/2", rd fl bake case. @ \$11.50

W.H., NX-35, 1.5 KV with 1000 ohms per volt, ext prec wire wound resistor & mtg clips, 3 1/2", rd fl bake case. @ \$6.95

W.H., NX-35, 2.0 KV with two ext wire wound precision 1.0 KV resistors to make this a dual range, 0-1 and 0-2 KV meter. Complete with mounting clips. @ \$7.25

W.H., NX-35, 20 KV with ext prec wire wound 1000 ohms per volt resistor & mtg clips. @ \$21.00

McClintock D-100-R-1 15 V D.C., 1000 r/v B1 sc, 2 1/2", bakelite case. @ \$3.00

Triplett 521 0-50 V, 1000 r/v 5 1/2" rd fl bake case. @ \$5.50

D.C. MICROAMMETERS

G.E., DO-41, 200 microampere mvt, Knife edge pointer, sc mkd "Set Carrier" supp with paper V.O.M.A. sc, 3 1/2", rd fl bake case. @ \$4.95

G.E., DO-41, 3 1/2", rd fl bake case, 150-0-150 microampere, 75 ohms resistance, zero center mvt, Blank sc mkd "Balance Set Power" @ \$4.50

G.E., DO-41, 500 microampere mvt, so cal 0-20 KV, supp with paper V.O.M.A. sc, 3 1/2", rd fl bake case. @ \$4.00

Triumph, 400 ua mvt, approx 500 ohms resist, sc cal 0-3, 0-15 & 60 V MA, 4". Rect fl bake case, Knife edge pointer. @ \$5.50

A.C. VOLTMETERS

G.E., AO-22, 150 V, 3 1/2", rd fl bake case. @ \$5.50

G.E., AO-22, 150 V, 400 cycle, 3 1/2", rd fl bake case. @ \$4.00

Weston 517, 300 V, 2 1/2", rd fl bake case. @ \$6.00

Weston 476, 130 V, 3 1/2", rd fl bake case. @ \$4.95

W.H., NA-35, 15 V, (100 Ma) 3 1/2", rd fl bake case. @ \$3.95

W.H., NA-35, 150 V, (10 MA) 3 1/2", rd fl bake case. @ \$5.50

Triplett, 332-J.P., 150 V, 3 1/2", rd fl metal case. @ \$4.50

A.C. AMMETERS

Roller Smith, Type TAS, 8 A, A.C. 3 1/2", rd fl bake case. @ \$4.50

Triplett, 331-J.P., 30 A, 3 1/2", rd fl bake case. @ \$4.00

Weston 476, 4 A, A.C., 3 1/2", rd fl bake case. @ \$4.95

RADIO FREQUENCY AMMETERS

Weston 507, 1 A, 2 1/2", rd fl metal case. @ \$3.50

Weston 507, 3 A, black scale, 2 1/2", rd fl bake case. @ \$3.50

W.H., NT-33, 250 MA, black scale, so cal 0-5, mkd "Antennae Current" 2 1/2", rd fl bake case. @ \$3.50

W.H., NT-35, 3 A, 3 1/2", rd fl bake case. @ \$5.50

G.E., DW-44, 1 A, 2 1/2", rd fl bake case. @ \$3.50

G.E., DW-44, 4 A, black scale, 2 1/2" rd fl bake case. @ \$2.95

G.E., DO-44, 20 A, 3 1/2", rd fl bake case. @ \$4.95

Simpson 135, 2 A, 2 1/2", rd fl bake case. @ \$3.50

Simpson 135, 8 A, 2 1/2", rd fl bake case. @ \$3.50

D.C. MILLIAMMETERS

G.E., DO-41, 1 MA, black scale, supp with paper V.O.M.A. sc. @ \$4.50

G.E., DO-41, 30 MA, 3 1/2", rd fl bake case. @ \$3.50

G.E., DO-41, 50 MA, black scale, 3 1/2", rd fl bake case. @ \$3.25

G.E., DO-41, 200 MA, 3 1/2", rd fl bake case. @ \$3.25

W.H., NX-35, 200 MA, 3 1/2", rd fl bake case. @ \$3.95

Simpson 25, 1 MA, 3 1/2", rd fl bake case. @ \$4.50

Simpson 25, 100 MA, 3 1/2", rd fl bake case. @ \$4.50

Simpson 25, 200 MA, 3 1/2", rd fl bake case. @ \$4.50

Weston 506, 1 MA, 3 1/2", rd fl bake case. @ \$3.95

Weston 506, 50 MA, 2 1/2", rd fl bake case. @ \$3.95

Weston 506, 200 MA, black scale, 2 1/2", rd fl bake case. @ \$3.50

Weston 301, 50 MA, 3 1/2", rd fl bake case. @ \$4.95

OIL FILLED CONDENSER G.E. "Pyranol", W.H. "Inertent", & Aerovox, .5 mfd/25,000 W.V.D.C. @ \$25.00

CONSTANT VOLTAGE STABILIZER G.E. Cat. #69 G 30152, Input 103 to 127 volts 57 to 63 c.p.s. Output taps 110, 115, 120 & 125 volts. Volt. Reg—1% at norm. freu., 850 V.A., 7.7 Amps at .93 P.F. Dimensions 30" x 15" x 10" Net wt. 280 lbs. @ \$59.50

CRYSTAL DIODE TEST SET 268/U Comp. with Instructions. @ \$5.95

"VIBROTEST" RESISTANCE & VOLTAGE TESTER Associated Research, Inc., Model #201. Resistance Range 0-200 megohms (at 500 Volts potential). 0-2000 ohms. Voltage Range 150-300-600 Volts D.C. 150-300-600 Volts A.C. Push button action for resistance readings—no hand cranking! Operates from internal Vibrator power supply off two number 6 dry cells. Complete with batteries, test leads and instructions in metal carrying case. @ \$60.00

TACHOMETER GENERATOR G.E. Type CM-5 Model 2CM5AEA. @ \$9.50

A.C. GEN. VOLTAGE REGULATOR made for 7.5 KVA, 120 V, 60 cycle Gen., Field current 0.2 Amps. Max regulated field resistance 750 ohms. With external variable 150 ohm resistor for pre-determined voltage settings. Ward Leonard type 5660. @ \$4.95 each. Ten for \$39.50

FILAMENT TRANSFORMER G.E., 110 volt 60 cycle input, 2.5 volt 40 Amp. Output 100 KVA, 3 K.V. insulation. @ \$1.75 each, Minimum order Ten pieces.

STEP DOWN TRANSFORMER, Jefferson Electric, 115 volt 60 cycle primary, 20 volt 10 Amp secondary, mounted in watertight box. @ \$3.00 each, Minimum order Ten Pieces.

VARIABLE RHEOSTAT, Ward Leonard 8" Class, 20 ohms 4.05 Amps. Complete with all hardware. @ \$2.95 each, Minimum order Ten Pieces.

STRIP HEATERS G.E. Cat. #2A305, 250 ohms 50 watt 115 V, 1 1/2" x 1/2" x 6" @ 60¢ each, minimum order Ten Pieces. G.E. Cat. # 2A 244G8, 88 ohms 150 watts 115 volt 1 1/2" x 1/2" x 7" @ \$1.00 each, minimum order Ten Pieces.

MICROSWITCH, Single Pole Normally closed, 10 A, 25 V. @ 30¢ each, minimum order Ten Pieces.

POTENTIOMETERS, Minimum Order One Hundred pieces of any one type. 100 ohms 25 watt Ohmite "H" 1/2" shaft @ 25¢ 5000 ohms 50 watt Ohmite "J" 2" shaft @ 30¢ 300 ohms 100 watt Ohmite "K" 1/2" shaft @ 40¢

BC-1072-A RADAR TRANSMITTERS

150 to 210 Megacycles; Operates off 115 volt, 60 cycle power line. This unit can be adapted to a 2 meter band transmitter but its chief value is for the parts it contains.

BLOWER, 115 volt 60 cycle 28 watts .38 1525 R.P.M. A.G. Reimond.

VARIAC, Gen. Radio type 200 B 115 volt input, 135 volt 1.5 amps. Max. output.

TUBES, 2-5U4G's; 1-807; 1-2x2; 1-6SN7; 1-6J5; 1-9002; 2-9006; 2-826.

METER, Simpson, 3 1/2", round, 0-5 Kilovolt and 0-10 M.A., D.C.

TRANSFORMERS, 1—with primary variable from 0.135 volt, secondary from 0-3500 volt; 1—with primary 117 volt secondary 6.3 V at 1.2 amp, 275 volt center tap to each side, 5.0 volt at 3 Amp; 1—with 117 volt primary, secondary 4 volt at 16 amp and 2.5 volt at 1.75 amp. Consists also of many other parts, relays, transformers, circuit breakers, interlocks, resistors, chokes, too numerous to itemize. Complete in metal cabinet 18"x20"x17 1/2"; net wt. 150 lbs.

NET FOB, N.Y. @ \$22.50

All items are Guaranteed and are Surplus New unless specified otherwise. All prices FOB, N. Y.—
25% deposit required on C.O.D.'s. Orders accepted from rated concerns on open account. Net 30 days

MARITIME SWITCHBOARD

338 Canal Street Worth 4-8217 New York 13, New York



Highest Values "Communications" at Lowest Cost

POWER EQUIPMENT

Line voltage regulator-TDY-1, Saturable reactor type Pri 95-130 v 60cy 1 ph 28A Sec 115v 60cy 1 ph 17-1A 2 Kw 100% PF.....\$160
 Line Voltage Regulator Pri 92-138v 57/63cy 1 ph 15A Sec 115v 7-15 A 82 Kv 96% PF.....\$135
 ITE Circuit Breaker 600v 60cy 115A.....\$12.50
 Carbon Pile Regulators-19v @5.7A.....1.00
 22v @ 3A.....1.00
 Mfrs. request quantity discounts

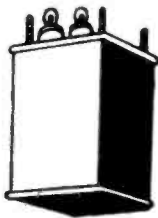

Plate Trans. Oil Pri 115/230 Sec single winding 21000 v @10ma.....
 Plate Pri 117 v 60cy Sec 6180@2A.....\$14.75
 Plate Pri 117v60cy Sec 1500 Ct@200ma & 5v3A, \$6.95
 Power Pair-Use two for PV 1900VCT @ .35 A Pri 117v 60 cy-3 taps Ea trans is cased .950 v NCT Pair.....\$10.00
 Plate Trans 117 v 60 cy tapped Pri Sec 2000 or 2500 ea side @ 500 ma. Stancor. Limited quantity.....\$35.50

Fil 5v3A 5v3A 5v3A 117 Pri.....\$3.25
 Fil 6.3@1A 6.3@1A 6.3@1A 117Pri.....2.45
 Fil 6.3@1A 5@3A 5@3A 117 Pri.....2.75

Filament Trans Pri 220v50/60cy Sec 5v 10 A 34000 ohm insulation.....\$26.50

Filament Trans 29000v test Pri 115 60cy Sec two 5v@5A Raytheon.....\$24.50

2 KVA Trans and Choke115v 50/60 cy 1 ph Output 17000 v @ 144 ma.....\$74.50

2.5 KVA Amertran rectifier-Input 208 v 3 ph 50/60 cy Out 0-25000 v @ 1 A 10% Reg 2.5% Ripple.....

REACTORS

GE 0.116 HY @ 0.15A Res 5.5 ohms.....\$7.50
 Raytheon 0.1 Hy @ 1.4 A Test 1780v.....1.50
 6 Hy 0.15 A Herm sealed.....2.00
 Capacitor Unit GE #69G143.....4.95
 Capacitor Trans GE #68G366LX.....3.00

OIL CONDENSERS

15 mf 220 AC 660 v DC.....\$1.75
 5-5 mf 400 DC.....1.05
 1-1 mf 7000 DC.....2.00
 Lots of 50.....1.50
 10 mf 6000 DC.....1.10
 1 mf 1000 DC......75
 2 mf 1000 DC......89
 4 mf 1000 DC.....1.00
 2 mf 660 AC......85
 1 mf 5000 DC.....4.95
 1 mf 7500 DC.....2.50
 10 mf 1000 DC.....2.00
 .01 mf 25 KVDC.....20.07
 .25 mf 20 KVDC.....17.50
 .10 mf 25 KVDC.....75.00
 .06 mf 15,000 v DC.....10.00
 .1 mf 10,000 v DC.....10.00



ELECTROLYTICS

200 ml 250 v.....2.00
 4000 ml 30 v.....2.50

MICAS

.006 mf 10000 v Sangamo G3.....17.50
 .00015 mf 20000 v G4.....25.00
 .002 mf 20000 v G4.....25.00
 .002 mf 15000 v G4.....20.00
 .002 mf 6000 v G1.....10.00
 .005 mf 15000 v G4.....20.00

AUTO TRANSFORMERS

Sorensen Ring type. 1/4" shaft, 115VAC 0 to 1/2 KVA.....\$8.50

COMPLETE RADAR SETS

S09-10CM. SURFACE SEARCH 4, 20 and 80 mile ranges; Raytheon, 250 KW peak power input to 2327 magnetron. Complete set including: spare parts, tubes, wave guides and fittings.
 S013-IDENTICAL TO S09. Complete set, used. Consists of: transmitter and receiver, PPI scope modulator, motor alternator, rectifier, power unit and new rotating antenna.
 SN RADAR-GE. low power, 5 and 25 mile ranges. Uses GL464 as pulsed oscillator, "A" scope, "S" band. Extremely compact; ideal for demonstration and laboratory work. 115V 60C operation.

SEND FOR INFORMATION AND OUR LATEST FLYER

MICROWAVE TUBES

3J31 (1 cm).....\$17.50
 3J31 MAGNET.....8.00
 2J26 (10 cm).....25.00
 2J32 (10 cm).....25.00
 2J38 (10 cm) with magnet.....37.50
 WE 700 A (L band).....45.00
 WE 720 BY (S Band) 1000 KW.....25.00
 2K25-723 AB Klystron.....7.75
 2C40 Lighthouse Tube.....2.40
 QK 59, QK 60, QK 61, QK 62 Tunable packaged Magnetrons, 10 cm.....45.00



SPECIAL TUBES

705A Rect.....\$3.25
 Socket for 705A......65
 3BP1.....\$3.95 5FP7.....\$3.00
 3FP7.....2.00 5JP2.....8.95
 5CPI.....\$4.95
 Diheptal CRT Socket 2 1/4" Diam......59
 829/832 Socket......50

THERMISTORS

D167332 Bead.....\$.95
 D170396 Bead......95
 D168391 Button......95
 D167613 Button......95

RELAYS Miniatures

SPDT 24 VDC.....\$.40
 SPST 28 VDC......40
 DPDT 28 VDC......45
 SPST 100 V Overload 380/1800 cy......40
 SPDT 110 AC 380/1800 cy......40

TELEPHONE RELAYS

SPDT with cover.....\$1.05
 DPST.....1.00

MISCELLANEOUS TYPES

SPDT 5VDC in can with 5 pr base.....\$.85
 DPDT 6 VAC Struthers Dunn.....1.45
 DPST 6 VAC Struthers Dunn.....1.35
 2 Section SPDT 6 VAC Wheelock type.....1.10
 SPDT 115 AC Leach.....1.00
 SPDT 115 AC WE Wheelock type.....1.25
 SPDT 115 VAC Kurman Latch Type.....2.49
 SPDT 115 AC GE with SPST thermal delay section.....1.95
 DPST 24 VDC Allied relay with SPST rev section 24 VDC and 12 VDC......75
 DPST Leach Antenna relay with SPST rev section 24 VDC and 12 VDC.....1.25
 4SPDT 24 VDCGM......85
 Solenoid Contactor 24 VDC Leach.....1.05
 Thermal delay 45 to 60 sec Edison type 1503 with 4 pr base.....2.95
 6 VDC Relay panel with 3 D'ST and 2 SPST on 10" by 7" panel.....2.75

TRANSMISSION LINE

RG 9U 51 ohm Z G.E. Silver Coated Copper. In 100 ft. lengths and 500 ft. reels.....per ft. \$.07
 RG 8U 52 ohm Z in 40 ft. lengths, per lengths \$1.00
 Connectors Right angle, straight plug, chassis socket-259 series. For above, any type..27 each

Signal Generator. 2700 to 3000 mc, CW output, meter, attenuator 115 v 60 cy operation. Type I 138 A with circuit diagram.....\$50.00
 Signal Generator, I-122A.....49.50
 Telephone Test Set EE 65 E.....15.00

MICROWAVE PLUMBING

1.25 CENTIMETER

Wave Guide Section 1" cover to cover.....\$2.00
 T Section choke to cover.....4.50
 Mitered Elbow cover to cover.....3.00
 Mitered Elbow and "S" sections choke to cover.....3.50
 Flexible Section 1" long choke to choke.....3.00
 Tunable Cavity with Coax input and output.....6.00

10 CENTIMETER

Sand Load (Dummy Antenna) wave guide section with cooling fins, app 23" high.....28.00
 Wave Guide to coax with flange, gold plated app 10" high.....17.50
 Rigid Coax Directional Coupler CU-90/UP 20 DB drop, has short right angle, about 8" Standing Wave Detector rigid coax 58 ohms.....5.00
 Coax Rotary Joint with mounting plate.....8.00
 Antenna in lucite ball, for use with parabolic Flexible Coaxial Connector, rigid coax to rigid coax 3/8" diam.....2.50

3 CENTIMETER

T Sections.....5.50
 Wave Guide Sections 2.5' long, silver plated with choke flange.....5.75
 Wave Guide 90 deg. bend E plane 18" long.....4.00
 Wave Guide 90 deg. bend E plane with 20DB directional coupler.....4.75
 Wave Guide 18" long "S" curve.....2.00
 Feedback Dipole Antenna, choke input, (used with parabolic).....4.50
 Rotary joint wave guide in/out choke to choke joint.....6.00
 Rotary Coupler choke input; round guide output.....5.25
 S Curve Wave Guide 8" long cover to choke.....2.50
 Wave Guide 2.5' long, silver plate, 180 deg. bend choke to cover.....5.95
 Duplexer Section using 1B24.....10.00
 Wave Guide with slotted section and rotary joint.....4.00
 Wave Guide 5' length per foot.....1.50
 Pick-up loop with adjustable tuning section, used in duplexer.....1.50

SEND FOR LENGTHY LIST.

MICROWAVE ANTENNAS

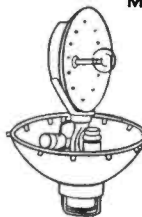

Relay System Parabolic reflectors aprx. range: 2000 to 6000Mc. Dimensions 4.5'x 3'. New.....\$85
 Dipole for above.....\$5.00
 TDY "Jam" Radar rotating antenna, 10cm, 30 deg. beam, 115V AC drive, New.....\$100.00
 SO Surface Search Radar rotating antenna, 10cm, 24" dish, complete with drive and selsyn motors New.....\$90.00
 Used.....\$47

PULSE TRANSFORMERS

All Standard name items Type K2450A Will receive 13KV. 4 micro-second pulse on pri., secondary delivers 14 KV Peak power out 100KW. \$15.00
 Hi Volt. Magnetron Input transformer #D-166173 with cooling fins.....\$12.00
 U 4298E-Pri. 4 KV. 1 microsecond Sec. 16 KV 16 Amps. Fil. pri. 115V 400 Cycle.....\$15.00
 Hi Volt input pulse Transformer #D169271.....\$9.95
 Radar pulse Transformer K2731 Diameter App. 11" vertical cooling fins.....\$19.50
 Pulse Input, line to magnetron K2748A.....\$12.00



SPECIAL

Maguire Wavemeter-#1539TFX, 3cm, vernier drive dial and resonant cavity.....\$20.00

Mail order promptly filled. All prices; F. O. B. New York City

Send Money Order or Check. Rated firms send P. O. Shipping charges only sent C. O. D.

Send for our latest microwave flyer, also our complete parts catalog.

COMMUNICATIONS EQUIPMENT CO.

131 E. LIBERTY STREET

NEW YORK CITY 7, N. Y.

Telephone Whitehall 4-7658



"TAB"

That's A Buy

NEW GUARANTEED

ELECTRONIC PARTS

VACUUM CONDENSERS

- GE 50MMF/7500V \$2.95
GE 100MMF/7500V 4.95
JEN 50MMF/20000V 6.95

GTD OIL CONDENSERS

- 10mfd/600WVDC \$1.25 @ 2 for \$1.89
20mfd/600WVDC \$2.50 @ 2 for 3.98
16mfd/400WVDC \$1.00 @ 2 for 1.59
2mfd/330VAC/1000WVDC
4mfd/330VAC/1000WVDC
15mfd/330VAC/1000WVDC
2mfd/2000WVDC
3mfd/2000WVDC
4mfd/2000WVDC
2mfd/5000WVDC
4mfd/5000WVDC
1mfd/10000WVDC
2mfd/12500WVDC
1mfd/25000WVDC



- MICROSWITCHES, 2 for 39¢ TEN FOR \$1.49
MICRO "MUSWITCH" leaf SPDT15A/125V TWO FOR 1.08
MICRO SWITCH plunger type TWO FOR 1.00
EDISON TIME delay RELAY 115V/10amp... 1.49

- TRANSF Hmt'ly cased pri 50-800cy/80-115V
Sec 1000VCT & 300V/110ma, 6.3V/5V/AA.
Three 6.3V/65A, 6.3V/125A & 2 H'cased
chokes 10h/110ma & Two oil condrs 3mfd/
330VAC/ 1000WVDC Pyranol & RK60/1641
Tube \$9.95
Transf 9800V/15ma, Pri 115V/60&400cy/
35ma 9.95
Transf 15,000V/35ma, Pri 115V/60cy... 15.95
GYRO SERVO BENDIX COMPLETE... 4.95

- W.E. DYNAMIC MICROPHONE & cord... \$7.95
SUPREME 542 Multimer 5000ohmperv/24
ranges Volts AC&DC to 1500, ohms 2meg.
DB-50 used LN... 15.95
SWITCH AH&H 60 amp/600V, 250amp/125V
(\$28) 1.00
Switch door interlock GE 7460340-G4 (\$1.50)... .69

- GAS GENERATOR SET PU-8/TTS-1 output
27VDC/400watts&115VAC/1400watts/40cy \$100.00

- METAL BOX NAVY 5 1/2x10Lx9 1/2"W
hasp & hds 1.45
AUDIO BAND PASS FILTER 60, 90&
150cycles totally encased & shielded,
each \$1.95 THREE FOR 4.50
WSTGHSE Dual 200 microampere meter
One zero ctr. 100ma Galvo & 200ma. 2.95
WSTGHSE 3 1/2" DB meter Sq-10plus6DB 2.95

- ART/13 COLLINS speaker amplifier... \$4.95
RC1073 SigGenerator & VTF w/centr... 24.95
SCR522 Rcvr & Xmitter 100-156mc's... 18.00
Navy sound powered telephones used... 9.95

- LS-3 Speakers PM in metal boxes used... \$3.95
CRYSTAL DIODE TEST SET 268U NEW... 15.95

- W.E. 125to250watt multi cellular nine
Driver trumpet complete... \$125.00
REFLEX Reentrant Trumpet projector 35
to55watts with W.E. head complete... 29.95
W.E. Driver PM heads 25to55watt water-
proof blastproof conservative rating
\$12.95 @ TWO FOR 21.95
W.E. Diaphragms ES671349-3 for PM
heads 3.95
Speakers PM4 Alnico/5130, 5" size 1.45
Universal tube to Voice coil transformer .98
Transf Plate to line 98¢; Line to V.C. .98
Transf multi-tap line to line ± 1DB... 1.95

- STORAGE BATTERY Willard 2Volt non-spill
\$1.98 @ TWO FOR \$2.98
Iron core slugs with screw... FIFTY FOR 1.00
IF STRIP 30Mc's/3-6AK5 & 1-6AL5... 9.49
HANDIE TALKIE BC611 Chassis, Coils&X... 7.95
RCVR BC455A with tubes ARCS set... 4.50

- VOLTAGE REGULATOR RAYTHEON
complete inpt ad taps 95-130V/60cy.
Output 115V, 58Amps. easy... 10.95
1% regulation
Hvt-Duty Voltage Regulator relax rack inct.
Inpt tapped 198 to 242V 50060cy. Outpt
220V/500WATTS: One half 1% Regula-
tion, Rugged dsg Tropicalized wgt70lbs. 39.95
TRANSF 115or230V/50-60cy/1400Watts... 19.95
Auto Transf 115/100/150/180V/60cy cased 2.95
Transf 110 & 220 to 220-440/190Watts... 4.50

- Meter rectifier dual bridge Bradley Labs... \$9.95
CRYSTAL DIODE 1N21 @ 45¢ THREE FOR 1.00

- AUTOSYN SYNCHRO TRANSMITTERS
115V/60cy TWO FOR \$18.00
SYNCHRO DIFFERENTIALS 115V/60cy 6.95
AUTOSYNS Types 5/50V, 2can be used 115V/
60cy TWO FOR 8.95
AUTOSYNS Aircraft AY1&5/24-28V/60&
40cy 3.95

- SONAR QBF echo ranging equipment \$1000.00
TELEPHONE Inverter, Converter ringing
machine KS-5492 D11 inpt 43-47VDC
outpt 75-90V/20cy's New... 25.00
RINGER Telephone Holtzer Cabot 6V/
20cy/6ma 1.49
TELETRING BD-90 TELKOR model H inpt
110V/60cy, outpt 90V/20cy 9.95
C "TAB" FOR TELEPHONE PARTS &
EQUIPMENT.

- W.E. Telephone jacks Type 223... FOUR FOR \$1.00
RM-13G Remote control telephone amplifier... 14.95
RM-53 Telephone remote control... 2.95
BC 605D Telephone Amplifier... 7.95
BC 191 Transmitter... 19.95

\$2 Min. order FOB N.Y.C. Add Postage all orders and 25% deposit. Worth 2-7230. Send for catalog. Specialists in International Export, School, College & Industrial trade. Money Back Guarantee.

- 808: 446/2C40... TWO FOR \$5.00
304TL/\$3.95; 450TL... 29.00
S07/95¢; 813/6.95; 815/... 2.19
829B/3E29/\$2.95; 83B1&socket 2.99



- 5B1, 5C1, 5BP1... each 3.55
955, 50, 57, 58A, 59 & socket... 90
954/50¢... FIVE FOR 2.00
2C26/75¢; 1625/65¢; 2V3G... .75
872A & SOCKET... TWO FOR 5.40
2050, 2X2, RK60, 6SL7 each .89
6V6/90¢ 6SN7, 12SA7, 6SJ7 @ .81
1E7G/89¢; 6SA7/71¢; 6B8G... .95
6J5M/55¢; 3A4/75¢ 6H6/65¢; .41
6AL5/81¢; 5Y3GT... .41
80/4C; 6SL7/81¢; 6C8, 6I7, CK1005, 12A6... 1.00
6K7/66¢; 6K8/81¢; 6AR6/81.49; 100TK... 5.75
717A/\$1.95; 703/\$5.95; VT127A/\$2.95; 6AG7... .90
6AK5/90¢; Ave for \$4.25; 6AC/185¢... 1.80
35L6, 50L6, 35Z5, 12SQ7, 12SH7... TWO FOR 1.80
6C4/65¢; 6J6/98¢; 6J4/\$1.45; 5U4G... .63
5R4G/\$1.05; 5Z3/55¢; 307/82; 9002... .80
9000/80¢; V1105/75¢; 6E5/69¢; 354/81; 6X5... .65
5Z4/89¢; 1L4/\$1.10; 6AB7/89¢; 6C8... .61
6C8G/\$1; 6F8G/\$1.26; NE16/99incom1/2W TEN FOR 2.00
836/\$1.39; 3B24/\$2.75; 24G/\$1.50; SN4/63111 3.75
6G6G/98¢; 1L4/98¢; 3S4/90¢; 810... 3.95
Neon GLOlamp NE20&51 rated 1/25W TEN FOR .98
Mazda S6/6Watt candelabra screw base TEN FOR 1.45
Mazda 49/2Volt/60ma Bayonet min base TEN FOR .90
Mazda 44/6.3Volt/250ma Bayonet min base TEN FOR .54
CONTACT "TAB" ALL TUBES REQUIRED
TUBES GTD EXCEPT BREAKAGE & BURNOUTS

- 1-222 CRYSTAL CALIBR SIGNAL GENERATOR
FREQ. METER, MONITOR, 8to154507Mc's
dual osc, covers IF ranges FM&TELEVISION
2nd, 3rd, 4th harmonics useable to 230Mc's SIX
tubes, micro vernier dial, reads 1/10 div. 110V
60cy operation. Rugged Design... \$39.95
NAVY RBC RECEIVER 4to27Mc's 16 tubes
Best RECVR ever—Used good cond... 75.00
CW3 RCVR NEW COMPLETE & DATA... 14.50
CW&F coils 3.1-10mc's or 0.4-16.5mc's... 2.70
BLOWER AIR 100cmTM & TR 115V/60cy... 5.95

- OSCILLOSCOPE 3" KIT 3BP1 includes Transf
11.5V/60cy Pri, 375VCT/110ma, 1320V/8ma,
5V/3A, 2.5V/3.25A, 6.3V/2.75A, 3BP1, 5Y3G,
2V3G Tubes, CONDSTR, CHoke RESIST, Low
& HV supply, THORDAISON NAVY PARTS,
Special... \$16.95
FOXBORO Strip Recorder with 110V/60cy
motor, MECH & ELEC actuated... 39.95
GRAPHIC recorder NEW boxed... 39.95
VIBRATOR PACK & STORAGE BAT-
TERY NEW... 9.95
C "TAB" FOR SIG C TECH MANUALS...

- KIT RESISTORS BT1/4-1W 50r2megs. 100 for \$2.50
KIT CONTROLS 50-2megs pots AB1... 10 for 2.50
KIT SILVER & MICA CONDENSERS... 50 for 2.80
KIT LUGS RADIO TYPE ASST... 100 for 1.00
KIT FUSES ASST LITTLE FUSE... 300 for 1.95
KIT GROMMETS RUBBER RADIO TYPE... 100 for 1.00
KIT SOCKETS, OCTAL/OCTAL, etc... 50 for 2.95
KIT G&P tube caps 1/4, 3/8, 9/16"... 50 for 2.95
CINCH miniature dual Xtal sockets... 8 for 1.00
CRYSTAL socket 24holder 3pins nycalex... 3 for 1.00
SOCKET for 4Xtal holders 1/2&3/4" sp. 2 for .25

- DYNAMOTOR NEW
HEFFP MAGNET
ALNICO 12/24V
inpt TAB TESTED
GTD 6V inpt 3
Amp. output 240V
100ma or 125ma
int duty: Rated
500V/50ma at 12 or
24V inpt. "TAB"
Special... \$3.49



- Dynamotor 12 or 24V inpt, 275V/110ma &
12V/3Amp Alnico P magnet unit... \$1.95
FILTERS OUTPT chokes & condns... .49
Dynamotor inpt 28V/14Amp, Outpt 250V/60
ma cont duty, wgt 2lbs; operates on 12V
fields in parallel, also 110V DC motor... 1.85
Dynamotor DM-4, inpt12or24V, outpt225V
100ma & 440V/200ma, cont duty rugged dsgn
Govt cost \$79. Special... 6.75

- Dynamotor DA3A, inpt28VDC, outp300VDC/
260ma 150V/10ma; 14.5V/5Amp cont duty,
for Radio set SCR 522. Special... 3.85
Dynamotor PE-94A, BENDIX MG-1A, DC
inpt24-28V, outp300V/260ma, 150V/10ma,
14.5V/5A inpt & outpt filters, Voltage regula-
tor & starting relays. Special... 9.95
GENERATOR 430VDC/150ma cont duty... 8.95

- 005mfd/3000WVDC DC mica \$1 @... Two for \$1.50
CRYSTAL DIODE IN34 @ \$1... Two for 1.50
CRYSTAL DIODE IN34 @ \$1.39... Two for 2.40
TRANSF modulation PP parallel 6L6's or
807's to PP 807's RF final cased IIV ins... 2.95
AMTRAM 6200V/750ma, 115V/60cy inpt... 24.95
Transf 115V/60cy inpt, 700VCT/120ma, 6.3V/
2.4A 5V 2Amp, SPECIAL \$2.69 @... Two for 5.00
PE157 VIBRATOR supply & PM SPKR. output
1.4V/5A, 125V/50ma cased... 4.95
Transf 115V/60cy inpt, 1200VCT/300ma W.E. 5.95

- PARABOLIC ANTENNA 24" Dia motor
driven \$16.95
ANTENNA TELESCOPIC 12" to 9ft... 1.49
ANTENNA AN30B 30-34" Auto type... .97
ANTENNA 16ft ins base & end mfg... 3.95
Antenna section SCM50/394"... 12 for 1.00
Antenna sect SCM 49&50/78 1/2", 2 sec. 4pr
AMATEUR XTALS RANDOM Freq's. 4 for 3.00
Transf 115V/60cyP, 500VCT/60ma, 6.3V/
4A 1.49
TR 115V/60cyP, 1350VCT/150ma, 6.3V/
5A, 5V/2A
Two 2mfd oil condrs, choke & RK60 tube. 10.95
TR 115V/60c, 640 VCT & 1540V/250ma
2 for 8.95

- CHOKE 15h/400ma/125ohms or 20h/300ma/
15KV \$7.00
CHOKE 20h/100ma 98¢; 50h/150ma... 1.49
Extension cord Hvidity 16 ft & M&F plug... 1.00
Antenna ant HP insulator 2-1/2"D&rod... 2 for .98
GE inst Voltage Control, Relay P&V/115V/
60cy 2 contact self reset, Calib 70/85/110/
10V 5.95
GE adj Thermostatic relay automatic Control
70-175DegF/115V/25Amp CR292B... 4.95
Variable Condsr 18-157MMF/3000V... .98
CHOKE SWINGING 15-29hys... 2.95
CHOKE GE 12h/300ma cased... 2.95

- CHOKE 15h/400ma/125ohms or 20h/300ma/
15KV \$7.00
CHOKE 20h/100ma 98¢; 50h/150ma... 1.49
Extension cord Hvidity 16 ft & M&F plug... 1.00
Antenna ant HP insulator 2-1/2"D&rod... 2 for .98
GE inst Voltage Control, Relay P&V/115V/
60cy 2 contact self reset, Calib 70/85/110/
10V 5.95
GE adj Thermostatic relay automatic Control
70-175DegF/115V/25Amp CR292B... 4.95
Variable Condsr 18-157MMF/3000V... .98
CHOKE SWINGING 15-29hys... 2.95
CHOKE GE 12h/300ma cased... 2.95

- Precision Resistors
IRC, SHALLCROSS, WE
MEPCO, INST. RES. CO.,
OHMITE FOR METERS
BRIDGES, AMPLIFIERS
*1/2% **5% *10% (REST 1%)
2000** 4300** 5100** 12000**
15000** 16675** 150000** 250000**
30000** 84000** 250000** 220000**
245000** 250000+ 950000+ 1155
ABOVE SIZES 30¢ each asstd... 10 for \$1.98

Table with columns for resistor values (1, 4, 5, 8, 15, 50, 100, 150, 170, 700, 1500, 7500, 30000) and prices for various sizes (1.75, 2, 2.5, 3, 4, 5, 7.5, 8, 10, 101, 101, 300, 400, 500, 800, 900, 1150, 4900, 5000, 7500, 15000, 17000, 20000, 50000, 570000, 600000, 700000, 950000).

- ABOVE SIZES EACH 60¢... TEN FOR \$5.00
ONE MEG WVV 1% each ea. 90¢ THREE FOR 2.00
1.8meg, 2.0, 4.5, 5, 10 SIX FOR 3.00
SPRAGUE H'MTCLLY SEALED 100r12
mer @ 1.49
IRC 1MEG 1/2% \$1.69; WESTON 2.5MEG 1/2% 4.95
IRC Dual 1MEG (2MIG) 0.2% acce HV ins... 4.95
WRITE FOR OTHER SIZES FROM STOCK.

"TAB" Dept. 9E, Six Church Street, New York 6, N. Y., U.S.A. "TAB" THAT'S A BUY CORNER CHURCH & LIBERTY STS., ROOM 200 THAT'S A BUY



NOW AVAILABLE FOR IMMEDIATE SHIPMENT!

TWO PARTY INTERCOM SPECIAL \$29.50

Ideal for factory or office use. Momentary Press-to-Talk switch provides fast positive action. Built for rugged use, has terrific pick-up. 115 v. 50-60 cy. panel controls includes volume control 110 v. switch 1 1/2 x 1 1/2 x 6 1/2—weight 28 lbs. Complete with tubes and additional speaker in metal case.



HS-16 HEADSET

8000 ohms Hi-impedance Noise proof Most sensitive phone built May be used as a sound powered intercom Light, durable, efficient. Molded neoprene earcups shaped to completely envelope entire ear. Adjustable steel headband extends or retracts. Especially suited to hams, engineers and aircraft pilots, recording engineers and many others. Can be used with simple Xtal to make complete radio receiver. Special Original cost \$25.00

commercial operators, aircraft pilots, recording engineers and many others. Can be used with simple Xtal to make complete radio receiver. Special Original cost \$25.00

6 foot extension cord

AMERTRAN VOLTAGE REGULATOR (TRANSTAT)

17.4 amps. maximum output 2 KVA single phase 115 v. 50 to 60 cy. 90 to 130 v. shipping weight 20 lbs.—a marvelous buy—First come first served

JOHNSON EDGEWOUND COILS No. 2263HM4

Just the thing for your antenna tuner. Heavy duty Hi-volt. insul. coil—ruggedly built—handles up to 750 watts R.F.—Turns can be removed to resonate at any amateur bands. Heavy mycalex insulation, air wound. Efficiently made to give lower surface resistance to flat winding. 26 turns spread 1/4" apart. Complete with four mounting lugs. Excellent buy. 2 for

G. E. INTERLOCK SWITCH

Hi-voltage is lethal—protect yourself and family—this switch automatically shuts off Hi-volt. circuits while adjustments are being made—low pressure—hi current capacity, positive action. Silver plated contacts. Pr.

CONDENSERS

- CF-1—2MFD 400 V. DC. \$.39
- CF-5—2MFD 600 V. DC. .80
- CF-6—4MFD 600 V. DC. .75
- CF-8—Tobe Dual 8MFD 600 V. DC. fits 4 prong socket 1.25
- CF-10—1MFD 1000 V. DC. .90
- CF-13—1MFD 1000 V. DC. 1.89
- CF-14—4MFD 1500 V. DC. 1.10
- CF-19—1MFD 600 V. DC. .39
- CF-22—2MFD 400 V. DC. 5.50
- CF-27—1MFD 2500 V. DC. 1.19
- CF-28—7MFD 800 V. DC. 1.50
- CF-29—2MFD 2000 V. DC. 2.10
- CF-30—1MFD 5000 V. DC. 6.75
- CF-31—8MFD 400 V. DC. 1.20
- CF-32—4MFD 400 V. DC. .69
- CF-33—10MFD 600 V. DC. 1.40
- CF-37—8MFD 2000 V. DC. 4.95
- CF-40—2.87MFD 3500 V. DC. 16.95
- CF-41—1.5MFD 12,000 V. DC. 14.95
- CF-42—7MFD 600 V. DC. 1.35
- CF-43—6MFD 600 V. DC. 1.09
- CF-44—100MFD 25 V. DC. 1.98
- CF-45—1MFD 3500 V. DC. 1.98
- CF-46—1MFD 3500 V. DC. 3.49
- CF-47—6MFD 1500 V. DC. 2.39
- CF-48—.05MFD 2500 V. DC. Perfect for Television 1.09
- CB-12—2MFD 2000 V. DC. 2.75
- CB-14—.5-59000 V. DC. 19.95
- CB-18—.25MFD 4000 V. DC. 2.95
- CB-35—.5MFD 2000 V. DC. 2.10
- CB-34—2MFD 440 V. AC. .98
- CB-16—.1MFD 440 V. AC. .79
- CB-21—.25MFD 20,000 V. DC. 19.95
- BATH TUB
- CB-13—.1—1MFD 600 V. DC. .45
- CB-17—.5MFD 400 V. DC. .39
- CB-19—100MFD 25 V. DC. .59
- CB-20—2MFD 400 V. DC. .59
- CB-36—.25MFD 600 V. DC. .39

Mallory Vibrapack 12 v. input, 150 v. @ 85 mils output—Extra Special at

75,000 ohm bleeder, 200 watts Ohmite—special 50,000 ohm bleeder, 100 watts, I.R.C.

DYNAMOTOR

12 v. dynamotor—ideal for portable 2 meter rig—low battery drain. 235 v. output at 90 mils. Can be run at 50% overload—gives up to 110 mils at 215 v. without damage for continuous duty—complete with filter. Special 2 for

Write For Latest Flyer I SL

NEW, STANDARD BRAND TUBES

TYPE	PRICE	TYPE	PRICE	TYPE	PRICE
1A3	\$0.98	12SK7	\$0.89	813	\$5.95
7A7GT	1.10	12SN7GT	.79	814	4.49
1A4G	.98	12SQ7GT	.99	815	2.25
1L4	1.10	12K8	1.25	826	2.25
1R4	1.29	14B6	.99	828	7.50
1H5	.99	28D7	.75	829B	3.95
1N5GT	1.90	30	.79	830B	5.25
1LN5	1.92	35Z3	.99	831	2.25
1R5	1.10	35L6	.99	832A	3.95
1S5	1.10	32L7	1.50	837	3.00
3Q4	1.10	35W4	.89	838	3.75
3Q5GT	1.10	37	.69	860	3.00
6AB7/1853	.99	38	.89	7193	.49
6AC7	.99	39/44	.59	8011	4.95
6AG5	.99	41	.69	021	1.25
6AK5	.99	45	.64	2X2	.84
6AL5	.99	46	.65	3B21	1.95
6AT5	.98	50B5	1.59	4C/35	.95
6B4	1.29	50L6	.93	516YG	1.15
6B6G	.89	70L7	1.59	5T1	.98
6C4	.64	71A	.69	5U1	.98
6C5	.51	71A3A	1.65	5W4	.98
6C21	12.95	954	.75	5Y3	.60
6C6	.75	955	.75	5Y4G	.59
6D6	.75	956	.75	5Z3	.89
6F5	.51	957	.75	6X5	.89
6F7	1.25	958A	.75	25Z6	.98
6F8	1.10	959	.75	35Y4	.99
6G6	1.10	9001	1.15	35Z5	.75
6H6	.59	9002	.98	92	.98
6H6GT	.89	9003	.98	83	.94
6I1	1.50	9004	.98	83V	.98
6J5	.59	9005	.98	84	.90
6I6	.89	9006	.69	217C	7.50
6J7	.80	10Y	1.50	250R	3.95
6K6	.69	15E	1.50	836	1.50
6K7	.79	HF100	6.95	806A	.75
6K9	1.25	HY615	.89	872A	2.25
6L6	1.25	V70D	6.90	884	.90
6L6G	1.20	100TS/	3.00	2051	.90
6L7	.98	2C26A	.75	RK60	1.25
6N7	1.25	2C34	1.15	RK77	3.50
6R7	.98	2C40	2.60	VR78	.75
6SA7	.90	2C44	1.75	VR90	.75
6SC7	.85	2132	20.00	VR105	.75
6SF5	.79	211	1.25	VR150	.75
6SH7	.65	2156	20.03	2225	1.95
6SL7GT	.79	3C24/	1.35	871	.95
6SK7	.79	3E29/	2.95	1613	.95
6SL7	.89	304TH	9.85	1616	2.95
6SN7GT	.69	307A	6.25	1619	.98
6SQ7	.89	41A	2.60	1624	.98
6SR7	.89	41A	2.60	1625	.98
6SS7	.75	6C1	.64	171B	1.95
6Q5	.98	705A	4.95	2AP1	2.25
6Q6	.98	715B	22.50	3AP1	3.45
6U5	.98	800	2.25	3BP1	2.95
6V6GT	.99	801A	1.75	3CP1	3.95
6Y6G	.89	803	8.95	5B1	5.45
7C4	1.50	805	3.75	5BP1	3.95
7F7	1.25	807	.95	5CP1	3.95
7L7GT	1.39	808	2.95	7BP7	7.95
12AT6	1.10	809	1.50	913	3.00
811	.89	811H	6.90	7EP4	23.50
12SA7GT	.99	812H	6.90		

8016.....\$1.49

NO MAIL ORDERS FOR LESS THAN \$5.00 All Tubes are guaranteed with exception of open filaments which are checked before they leave our warehouse. All tubes shipped via Rail Express.

AMPHENOL COAX CONNECTORS

- 83-1SPN \$0.45
- 83-1R .45
- UG-12/U .59
- 83-1T 1.49
- 83-1AP 1.49
- UG-28-U .79
- 83-1F 1.49
- 83-1F .99

SELSYN MOTORS

Synchronous Type

- Pair in Series for 110 v. AC. Type I—5 1/4" long, 3" dia.—50 v. AC. 50 cy.—1 lbs. \$ 9.95 pr.
- Type II—8 1/4" long, 4 1/4" dia.—115 v. AC. 50 cy. 11 oz. 12.95 pr.
- Type III—11 1/2" long, 2 1/2" dia.—50 v. AC. 50 cy.—11 oz. 6.95 pr.

SYNCHRO—DIFFERENTIAL

Model #1943—C78249-CAL-11280 Bendix Aviation 115 v.—60 cy. 6" length to end of shaft x 4 1/4" diameter \$ 9.95

NEW BANTAM BLOWER

Blower 6 v. AC or DC hi speed blower made by John Oster. Rated at 5000 RPM—1.8 AMP—made for continuous duty—1 1/2" overall diameter—1" blower output—1 1/4" blower intake \$5.95

CONTINUITY CHECKER

Neon type—in black metal box 3-3/8" x 5" x 3 3/4" complete with leads & AC Cords \$2.50

300 OHM TWINEX—unaffected by moisture—will handle 3 kilowatts of R.F.—losses at 40 MC per 100 ft. are 3/10 DB. Best buy in the .08

MICRO SWITCH—can be used on AC with ratings of 1200 watts up to 600 v. AC also for DC work—normally open—Die Cast— \$1.25 BZE-2RQ9TN

CRAMER TIMER



Type #7766346P2 adjustable from 1-30 sec. S.P.D.T. with starting relay for remote control motor and contacts separate.

\$9.95

Type #P7766346P4 adjustable from 4-120 sec. S.P.S.T. normally closed motor and contacts separate. \$6.95



FULL WAVE SELENIUM RECTIFIER

Perfect for bias application—Use your DC relays from an AC source. Only requires

3" x 1 1/2" mounting space Rectifier for input up to 300V @ 40 ma output.

\$.89 or 5 for \$4.00

R. F. INDICATOR PROBE

Z601—has a fixed xtal (VHF) type and a pick up coil. Coax lead, coax connector at end. Probe has 4" bakelite handle. Used with a 0-1 Ma. meter across it. For checking R.F. in lines, neutralizing finals, etc.

\$1.98

HEINEMANN CIRCUIT BREAKERS

10 Amp, 117.5 V. A.C., Curve 1 \$1.25
0.010 amp coil, 2340 V., Rect. D.C. Curve 4, 2899, Res. 5000 ohms Max. \$2.95

TRANSFORMER SCOOP

TC-5—Western Elec—KS9547—332-0-332 v @ 246 MA. 10 v. C.T. 10 A., 2.5 v. C.T. @ 10 A., 2,000 v. ins. 5.1 v. @ 3 A., 6.4 v. C.T. @ 5 A.—Will supply every voltage for rig except plate of modulators and final. \$4.25

TS 5—Western Electric—D303184—Hi. Volt 4200 v. @ 9 MA Lo. Volt. 640 v. @ 200 MA—FII. 6.4 v. @ 5 A., 5.4 v. @ 3 A., 5.1 v. @ 3 A., 2.5 v. @ 1.75 A., Complete Television Hi. & Lo. Volt. Trans. In one compact oil filled unit—Will handle any television tube. \$12.95

TS 6—Scope Transformer—2500 v. @ .4 A., 2.5 v. @ 1.75 A., 6.3 v. Z .6 A. \$9.95

TCH 2—Scope Transformer 1750 v. @ 4 MA and matching fl., trans 6.3 v. @ .8 A., 2.5 v. @ 1.75 A., 2.5 v. @ 1.25 A. \$7.95

HF 16—Filter Choke 10 Hy. @ 150 MA \$1.95

LC 2—25 MH R.F. Choke. \$.59

METERS

- MM 4-0-100MA Model 301 Weston 3 1/2" \$3.95
- MM 10-0-1 amp DC-Model 301 Weston 3 1/2" 3.95
- MM 14-0-150MA NX 35 Westinghouse 3 1/2" 3.95
- MM 19-0-870MA Weston Model 301MA 3.95
- MM 33-0-1MA-MD-300 I K-McClintock 3 1/2" 3.95
- MR 13-0-8 R.F. amp—425AM-Weston 3 1/2" 4.95
- MZ-1-0-130 v. AC-25 to 125 cy.—376M Weston 3 1/2" 3.95
- MV 8-0-4 K.V. DC—Roller-Smith 3 1/2" 2.95

RELAYS

- KR 5—Leach Type 1357—115 v. AC—DPDT \$2.00
- KR 6—Struther Dunn—115 v. AC—DPDT \$1.65
- KR 10—Allied #KS5910—115 v. AC 10 amp contacts TPDT \$1.98
- KR 11—Allied #KS5910—115 v. AC 4 PDT 10 A. contact \$2.50
- KR 12—Struther Dunn—115 v. AC—2 relays on one mount. SPDT & SPST 10 A. cont. \$3.95
- KR 13—Kurman Elect. #X1400 D.C. overload relay with AC reset coil 115 v. AC SPDT \$4.95
- KR 15—Sperry—Thermo Time Delay ADJ 15-45 Sec. 115 v. AC 60 cy SPDT. \$3.50
- KR 17—Leach—1177BF—115 v. AC Ceramic Insul. TPDT \$1.75
- KR 21—Whealock Sig.—115 v. AC—5 Amp. Contacts DPDT—B3 x 4. \$2.25
- KR 22—G.E.—CR2790E105—115 v. AC or 230 AC Heavy Duty DPDT \$4.95
- KR 24—Adlake Mercury Time Delay Relay—#1040-80 normally opened .3 to 5 sec 115 AC \$8.95
- KR 25—Struther Dunn—115 v. AC 30 amp. contacts DPST \$4.95
- KR 26—G.E. instantaneous over current relay—Type PBC 3 amps @ 115 v. \$24.95

Birnbach No. 4175 feed thru insulator. .29

ROTARY SWITCH—3 deck 9 position non-shortening ceramic wafers. Each. \$1.25

R.F. Choke R154 1MH @ H600 MA with mounting bracket. \$1.25

R.F. Choke 3/2 MH @ 100 MA on ceramic with threaded mounting hole. .18

All Prices f.o.b. N. Y. C.

NIAGARA RADIO SUPPLY CORP.

160 GREENWICH STREET, NEW YORK 6, N. Y.

CREDIT EXTENDED TO RATED ACCT'S

METERS

SURPLUS BARGAINS

WESTON MODEL 663



Volt-Ohm-Milliameter

Model 663 is widely used for general industrial and experimental work where a broad range of resistance measurements, with D.C. voltage and current ranges is required.

Ranges
 Resistance: 6 ranges 1 ohm to 10 Megohms
 Voltage : 6 ranges 2.5 volts f.s. to 1000 volts
 M.A. 4 ranges 1, 5, 25, 100 M.A.
 Comes complete with batteries, test leads, and in an Oak Carrying Case.
 Old List Price \$71

Your Cost \$29.50

WESTON MODEL #1



Portable D.C. Voltmeter
 — 0-3/15/150 Volts —
 Triple Range.

Used as a reference standard. Accuracy unaffected by wide changes in temperature.

Accuracy: 1/4 of 1%. Knife edge pointer—mirror scale.
 Scale length: 5.18". With genuine leather case.
 List: \$117.13.

Your Cost \$57.50

STEPDOWN TRANSFORMER



Made by General Electric. Heavy duty stepdown transformer, with considerable overdesign. Ideal for rectifier applications, low voltage heating, general laboratory use, etc. Open frame type.

Input: 115 Volts—60 Cycles
 Output: 15 Volts (at full load)
 Capacity: 180 V.A.
 Size: 3-1/2" x 3-1/2" x 4".

Your Cost \$3.75

Quantity prices available

SPECIAL METERS

0-3 Amps. R. F. Weston 425.....\$5.95
 0-15 Amps. R. F. Weston 507..... 3.50
 Resistance Thermometer 30° F. to 230° F.
 with res. bulb. Weston #727..... 4.95
 Weston 637 Freq. Meter. Aircraft case 3 1/2".
 Range: 350-450 Cycles, complete...4.95

AMPERES A. C.

0-3 Amps 3" Rd. Westinghouse NA 35 (scale marked 0-120)\$3.50
 0-5 Amps. 4" Rd. Weston 642 (surface metal case) 7.95
 0-5 Amps. 4" Sq. Triplett #431 (flush bakelite case. Scale: 0-150/300 V.)... 2.95
 0-30 Amps. Triplett 3"Rd..... 3.25

All Items Listed in This Ad Are New, Unless Otherwise Specified

PORTABLE VOLTMETER



Westinghouse PX-14

Range: 0-3/15/150/750VDC

A rugged instrument of medium accuracy. Magnetically shielded, bakelite case. Mirror Scale.

Accuracy ±1%. Scale Length: 3.2". Size: 5-1/4" x 4-1/4" x 1-3/4".

List Price \$46.00

Your Cost \$17.50

RESETABLE COUNTER PRODUCTIMETER

MOD. 5H11R 5 DIGIT
 HEAVY DUTY SIZE

Approx. Size 5"x3"x2"
 Size of Figures—3/8" High

Your Cost \$8.50 Net Ea.

Limited Quantity Test Equipment

Ferris Microvoltage Model 20B
 Boonton Q Meter Model 170A
 G.R. Output Meter Type 483-F
 Hewlett-Packard Attenuator Model 350A
 Measurements Corp. Standard Signal Generator 65B
 G.R. Impedance Bridge Type 650-A

MICROAMPERES D. C.

0-100 Microamps. Res: 100 Ohms—3" Rd. Westinghouse NX-35\$7.95
 (Ideal for pyrometry & Photo-electric work)
 0-150 Microamps. Res: 500 Ohms—2" Rd. G. E. DW-51 or NX-33.....\$3.75
 840-0-840 Microamps (blank scale) Weston 643—4" round—metal case.....\$4.50

MILLIAMPERES D. C.

0-1 Mills—3" Rd. G. E. DO-53.....\$4.75
 0-1 Mills—3" Rd. Weston 301 6.75
 0-1 Mills—3" Rd. Weston 301 scale: 0-1.5 KV 5.75
 0-1 Mills—3" Rd. Marion (special scale) 3.25
 0-1 Mills—2" Rd. G. E. DW-41 (special scale) 1.95
 0-5 Mills—2" Rd. Dejur S-210 2.15
 0-15 Mills—2" Rd. Weston 506 3.25
 1-0-1 Mills—3" Rd. Western Electric Surface (scale 100-0-100) 1.35

AMPERES D. C.

0-1 Amp. 3" Rd. Weston 301.....\$5.95
 0.15 Amps—4" sq. Triplett #421.... 2.95
 0-3 Amps 4" sq. Triplett #421..... 2.95
 0-10 Amps—3" Rd. Simpson #25.... 4.95
 30-0-30 Amps 3" Rd. Simpson #25.. 4.95
 0-80 Amps—2" Rd. Weston #506 (charging Amp caption) (with ext. 50 MV shunt) 3.25
 0-300 Amps 3" Rd. Roller-Smith Type TD (with ext. 50 MV shunt)..... 4.95
 0-300 Amp. same as above (without shunt) 2.50
 0-300 Amp. 4" Rd. Weston 643 (flush metal case) Black scale—with ext. shunt.. 8.50
 0-300 Amp. same as above (without shunt) 6.00

WESTON MODEL 269 FAN SHAPED METER



One of the Weston popular fan shaped line. Exceptionally long scale for size of instrument. Accuracy—within 1%. Scale length—4".

Spade pointer. Here is a good movement for special purpose instruments. Comes with blank scale with arc drawn in. Ready for plotting calibration points. Can be used to make up any range of volts, amps, MA., etc.

Full scale deflection—5 M.A.—40 M.V.
 List \$29.83

Your Cost \$8.95

10 for \$75.00

WHEELCO CAPACITROL #221



The original Wheelco electronically controlled temperature regulating pyrometer, cold junction compensated, high resistance movement. Scale length:

Ranges available:—0.400°F. 0-1200°F.
 0-800°F. 0-2000°F.

Net Cost. \$150.00 Your Cost: \$98.75

BODINE MOTOR



A small but rugged built-in spur gear reducer motor. Three wire reversible, condenser start. Type KC1-22. 115 volts — 60 cycles — 3.7 R.P.M. 7.5 watts—85 inch ounce torque.

Your Cost \$7.50

VOLTS D. C.

0-10 Volts 3" Rd. ElectroTech.....\$3.75
 0-20 Volts 3" Rd. Weston 506-1000 Ohms/V 3.50
 0-50 Volts 4" Rd. Weston NX-37 200 Ohms/V 6.00
 0-150 Volts 3" Rd. G. E. D-41..... 4.75
 0-150 Volts 3" Rd. Weston 301-200 Ohms/V. (black scale)..... 4.95
 0-150 Volts 4" Rd. Weston 643 (flush metal case—black scale) 6.75

VOLTS A. C.

0-15 Volts—3" Rd. G. E. AO-22 (black scale)\$2.95
 0-75 Volts—4" Weston 642 (surface mtg) 7.25
 0-150 Volts—3" Sq. or Rd. Simpson 57 or 556.00
 0-250 Volts—4" Rd. Triplett #534-B (surface mtg—bakelite) 4.50
 0-300 Volts—4" Sq. Triplett #431 Scale: 0-300/600 V. 4.50
 0-300 Volts—4" Weston 642 (surface metal case) 9.00

POWERTRON Electrical Equipment Co.

SURPLUS DIVISION: ELECTRO-TECH EQUIPMENT CO.

119 LAFAYETTE STREET

Phone: Worth 4-8610

NEW YORK 13, N. Y.



RADAR EQUIPMENT

G. E. Model S. Q. sets new in portable cases, 90-130 volt, 60 cycle, 320 watts. Choice A, B, or P. P. I. presentation. 300 yards minimum range, max. 3, 15, 45 miles. 10 cm. Ideal for schools, laboratories, small boats, etc.

S.G. and SO-3 spares and component units. SO-1 and SO-8 complete antenna assemblies, brand new packed for export. Also 90° waveguide elbows, parabolic reflectors, nozzles, and radiators.

Crystals—98.35 kc. Raytheon.

SYNCHROS

G.E. selsyn Control Transformers 115-55 volt, 60 cycle, model 2J5FB1.

Bendix CAL-18300, 115 volt, 60 cycle. Diehl C78414, 115 volt, 60 cycle. (Both are Army ordnance synchro generators which may be used in conjunction with above control transformers.)

Electrolux Synchro-Repeater 115 volt, 60 cycle, type XXI, C 78863.

Bendix, Mod. 4, type 5SF, 115 volt, 400 cycle.

TRANSMITTING EQUIPMENT

BC-325 types B & C. Freq. range 1.5 to 18 mcs. Output 400 watts C. W. or 50 watts phone. 110 V. 60 cy. used but in excellent operating condition.

Wilcox 98A transmitters, complete from microphone to antenna.

MD1/FRC Modulator units consisting of two complete 500 watt audio channels. Everything from microphone input to modulation transformer output built into metal cabinets. 110 V. 60 cy. Brand new.

METERS

Westinghouse NX35 D.C. milliammeters O-800, 3 1/2" round bakelite cases.

Cramer Elapsed time meters RT21H, 3 1/2" round bakelite cases.

Triplet D.C. Milliammeters 0-150, 2 3/8" square bakelite cases.

J.B.T. 30-FX, 100-130 volt 46-64 cycles frequency meters, 3 1/2" bakelite cases.

ID-24 Indicators.

Marion Instrument D.C. Kilovolt meters for use with 1 meg. external resistor, round 2 3/4" bakelite case.

W. E.—4 to +6 D. B. 1 MW in 600 ohms, FS = 1 MA. A.C., 3" rd. bakelite.

LABORATORY EQUIPMENT

Measurements Corp. Model 84 standard signal generators, 300-1000 mcs.

Ferris Crystal Calibrator, Model 34A.

Hewlett Packard Interpolation Oscillator, Model 6225B.

Weston #1 Precision 0-150, 0-1500 milliammeters in leather cases.

G. E. Model LU Radar test set.

RELAYS & SWITCHES

Western Electric D-168479 mercury-type, enclosed in sealed metal tube base.

A high speed switching relay for use where large amounts of current are used, and in servo mechanical systems. Will operate at 100 times per second and is also employed in vibrator power supplies for square wave generators.

Leach, types 1355, 1154-A, 455C.

Struthers Dunn, types 1BXK129, 1BXX107, 1XBX105

Western Electric, type 479H.

Sperti Vacuum #S1A.

CABLE AND CORDS

76-26-PB1 beaded coax cable.

PJ 36-6" patch cords.

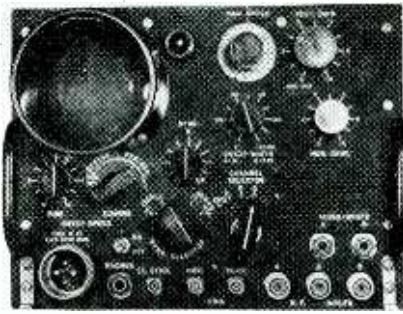

PAN-OSCILLO-RECEIVER

Ideal for laboratory, television and general service work

Performs work of four units:

1. Panoramic Adaptor: For use with any receiver with I.F. frequency of 405-505 kcs., 4.75 to 5.75 mcs., and 29-31 mcs.
2. Oscilloscope: Visually checks received signals, monitors transmitter output—percentage modulation, carrier wave-shape, etc.
3. Synchroscope: External inputs provide synchroscope action.
4. Receiver: Three inputs provide facilities for use with converters to cover wide range of frequencies to 10,000 mcs.

Features:

- * 3" scope tube
- * 21 tubes
- * Aircraft type construction
- * Variable sweep 35-40,000 cy
- * Weight 40 lbs.
- * Transformer built in for 110 V. 60 cycle operation.
- * 2 I.F. stages—double conversion.
- * 2 Video stages in push pull to vertical plates.
- * Pentode output audio monitor.
- * Multi-Vibrator horizontal sweep (radar type).
- * Horizontal sweep amplifiers P. P. to horizontal plates.

Surplus equipment tested and guaranteed in perfect operating condition. We have sold hundreds of these units during the past year to leading schools, laboratories, amateur operators all over the world.

Price \$97.50 f.o.b. Tuckahoe, N. Y. (Mail 50 cents for 80 page Technical manual and instruction book)

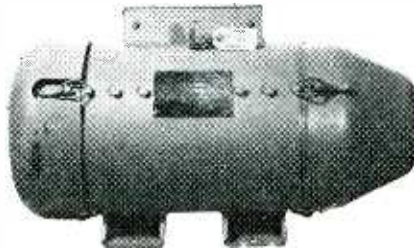

MOTOR GENERATORS

Brand new. Built by Allis Chalmers to rigid specifications of the U. S. Navy.

K.V.A. output 1.250 R.P.M. 3600

K.W. output 1. Cont. Duty Ph. Single P.F. .80 Cycles 60

Volts input 115 D.C. Volts output 120 A.C.

Amps input 14 Amps output 10.4

Length 26"; width 12-7/8"; height 13". Compound accumulative A.C. and D.C. fields. Centrifugal starter. Splashproof covered. Frequency adjustable to load, plus or minus five cycles.

Price \$87.50

Identical Machine, but 230 volts D. C. input, \$125.00

Set of Replacement Spare Parts for Either Machine \$29.50

Prices f. o. b. Tuckahoe, New York Immediate Delivery

PORTABLE SWITCHBOARDS

BD-71: 6 line; local battery, mon-ocord, W/CT, repeating coils on 2 lines to permit simplexing telegraph circuit. New.

Price \$40.00 each

BD-72: 12 line, local battery, mon-ocord, magneto type, repeating coils on 4 lines permitting simplexing for telegraph, night alarm bell, carrying strap and 4 collapsible steel legs. New.

Price \$60.00 each

Discounts for quantity orders.

MASPETH TELEPHONE & RADIO CORPORATION

427 Flatbush Ave. Extension
Brooklyn 1, N. Y.
Telephone NEvins 8-5709

Special Values

Panel & Portable Meters

D. C. Microammeters:
50-100-200-500 microamps. High Resistance Voltmeters Vacuum Thermo-Couple Meters 3 1/2" & 4 1/2" Round & Rectangular

Multirange Portables:
readings from 10 microamps. full scale
Precision Electrical Instrument Co.
146 Grand Street New York 13, N. Y.

RADIO COMPASS LOOPS

New LP21LM, LP21A and LP21F compass loops. Original cartons. Write for quantity prices.

SERVO-TEK PRODUCTS CO.
247 Crooks Ave. Clifton, N. J.

RADIO TRANSMITTERS

New TCS Transmitter Receiver Sets 20 watt phone VFO and XTAL, 1.5 to 12 mc complete spare parts, tubes, remote control, etc. \$250 each.

VILLAGE RADIO EQUIPMENT
201 West 16 Street New York City

SHEET METAL MACHINERY

NEW and Used — Brakes — Shears
Forming Rolls — Folders — Punches — Di-Acro, Pexto, Niagara & Whitney Equipment

B. D. BROOKS CO., INC.
Han. 5226
361 Atlantic Ave., Boston, Mass.

8.5 KVA PLATE TRANSFORMERS

Press Wireless—3 phase
220 V. primary—3600 V. secondary
\$75.00 each

WESTERN ENGINEERS, LTD.
Box 1111, Oakland, California

ELECTRONICRAFT, INC.

5 Waverly Place

Tuckahoe 7, New York

Telephone: Tuckahoe 3-0044



SEARCHLIGHT SECTION



POWER TRANSFORMER

1600 V-O-1600 V. 350 ma. Gov't Rating—7 x 6 1/2 x 5 1/2—31 Lbs. **\$12.95**



G.E.—Rotary Switch, 2 deck—each deck SP3P Mycalex wafers. Can be used in Hi-frequencies up to 250 Mcgs. Perfect for band switching in an exciter or final. Heavy silver plated spring contacts. Positive action by spring controlled roller bearing. **\$1.29**

TRANSFORMERS—115 v 60 cyc

Hi-Voltage Insulation

1600v @ 4ma; 700VCT @ 150ma; 6.3v @ 8a.	\$8.50
3710v @ 10ma; Two 2.5v @ 3 amp.	9.95
550-0-550v @ 150ma; 5v @ 3a; 2X-6.3v @ 500-0-500v @ 100ma; 5vct @ 3a.	4.95
442-0-442v @ 1000ma.	9.95
425-0-425v @ 150ma; 6.3v @ 7.5a; 6.3v @ 3a; 5v @ 3a.	5.95
400-0-400v @ 200ma; 5v @ 3a.	4.95
350-0-350v @ 150ma; 6.3v @ 6a; 5v @ 3a; 7.5v @ 1a.	4.95
350-0-350v @ 35ma—XLNT for Volt Doubler	1.49
300-0-300v @ 65ma; 2X-5v @ 2a; 6.3v @ 2 1/2a; 6.3v @ 1a.	3.49
120-0-120v @ 50ma.	2.49
2.5v @ 10a. 10KV test.	3.25
5v @ 115a.	14.95
5v @ 190a.	17.50
6.3v @ 6.6a.	3.25
6.3v @ 3.1a.	1.95
6.3v @ 21.5a; 6.3v @ 2a; 2.5v @ 2a.	6.95
1700v @ 4ma; 2.5v @ 2 amp; 6.3v @ 1 amp.	8.50
1540v @ 4ma; 340-0-340 @ 250ma.	7.50

BLOWER

Hi-air blast, designed for transmitting tube service. Motor operates on 100-125v 60 cycle at 7000 RPM. Noise free with self contained chokes and fillers. Enclosed in satin finish, aluminum cabinet. Measures 4" high x 2 3/4" x 3 1/4". Many uses. Super buy at.....**\$5.95**

SELENIUM RECTIFIERS

Full Wave Bridge Types

INPUT	OUTPUT	
up to 18v A.C. up to 12v D.C.	1 amp.	\$1.95
up to 18v A.C. up to 12v D.C.	5 amp.	4.45
up to 18v A.C. up to 12v D.C.	10 amp.	7.45
up to 18v A.C. up to 12v D.C.	15 amp.	9.95
up to 18v A.C. up to 12v D.C.	30 amp.	14.95
up to 36v A.C. up to 28v D.C.	1 amp.	3.45
up to 36v A.C. up to 28v D.C.	5 amp.	7.45
up to 36v A.C. up to 28v D.C.	10 amp.	12.95
up to 36v A.C. up to 28v D.C.	15 amp.	18.95
up to 115v A.C. up to 100v D.C.	25 amp.	2.95
up to 115v A.C. up to 100v D.C.	.6 amp.	6.95
up to 115v A.C. up to 100v D.C.	.5 amp.	19.95

PERMALLOY SHIELDS for CATHODE RAY TUBES

3" Shield	\$1.49
5" Shield	1.98

HIGH CAPACITY CONDENSERS

4000 mfd.—18WVDC	\$1.95
4000 mfd.—30WVDC	2.95
1000 mfd.—15WVDC	.99
2000 mfd.—50WVDC	1.96

FILTER CHOKES—HI-VOLTAGE INSULATION

4 Hy @ 250ma	\$1.98	12 Hy @ 300ms	\$3.95
10 Hy @ 250ma	2.49	15 Hy @ 100ma	2.95
10 Hy @ 400ma	4.95	15 Hy @ 125ma	3.25
12 Hy @ 100ma	2.95	30 Hy @ 70ma	1.95
4 Hy @ 600ma	5.95	1 Hy—5 amps	6.95

SCR-522 100-156 MC.

RECEIVER AND TRANSMITTER Licensed for Railway and Taxicab Use

The ideal all-purpose transmitter-receiver for work in the 100-156 mc. spectrum. Four channel pushbutton operation, crystal-controlled, AM, phone, mobile or fixed station service. Ideal for amateur, aircraft, marine, railroad, taxicabs, police and experimental. Amplitude modulated—High transmitter output. Receiver has 10 tubes and transmitter has 7 tubes including two 832's. 60 cycle operation. Complete conversion instructions and schematic furnished with each unit. Tube complement 2—832; 3—12A6; 1—6G6; 2—6557; 1—12J5GT; 1—12C8; 1—9002; 3—9003; 1—12A117GT and 3—12SG7.

with tubes **\$14.95**
Complete

BC-348 RECEIVER

Built for continuous duty, this band switching, six band receiver with a freq. range of 200 to 500 kc. and complete 1500 kc. to 18,000 kc. Has automatic noise compensator—constant sensitivity on all bands—output at 300 or 4000 ohms—xtal filter AVC-MVC-BFO; Smooth vernier tuning; 90 turns of tuning for each band. Complete with built-in dynamotor for 28v DC. 8 tubes. Conversion instructions and schematics. Wonderful buy at.....**\$49.50**
Conversion kit for 110v-60 cyc. operation, complete\$7.50

'SILVER BALL' ANTENNA SWITCH

100 Amp. 2500 V. Navy Rating
Terrific Buy **\$1.79**

TUBES (Brand New) Army-Navy Inspected

1B24	\$13.95	311	\$ 5.95
2AP1	2.25	371B	5.95
2C40	2.79	450TH	41.50
2D21	1.49	703A	1.50
2V3G	1.25	705A	4.95
2X2	.84	715B	4.95
3AP1	3.90	721A	4.95
3BP1	2.95	726/AC	7.50
3E29	2.95	801	1.75
5BP1	3.95	802	1.75
5BP4	4.95	803	8.95
5CP1	3.95	804	9.95
5JP1	19.95	805	3.75
5LP1	19.95	806	14.95
5R4GY	.98	807	.95
5Y3	.59	808	2.95
6AB7	.99	809	1.50
6AC7	.99	810	3.50
6AG5	.99	811	1.95
6AG7	.99	812	3.95
6AJ5	1.89	812H	6.95
6AK5	.99	813	5.95
6AL5	.99	814	4.45
6AR6	1.29	815	3.95
6B4G	1.29	826	2.25
6C1	.69	829 A-B	3.00
6C5	.49	832	2.25
6F6	.89	833A	49.50
6F6G	.59	834	2.95
6J4	1.50	835	2.95
6J5	.59	836	1.75
6J6	.89	837	2.50
6L6	1.25	838	3.75
6L7	.98	841	1.20
6N7	1.39	861	89.95
6SH7	.69	866	.99
6SL7	.89	872A	2.50
6SN7	.69	884	1.10
6SR7	.89	885	1.10
7A4	.95	909	2.25
7F7	1.25	913	3.00
7L7	1.59	954	.75
9JP1	14.95	955	.75
10Y	1.50	956	.75
12X3	1.50	957	.75
15E	1.50	958	.75
HK24	1.75	959	.75
28D7	.75	1003	1.98
30	.75	1616	2.95
35T/PG	3.50	1619	.75
VR90	.75	1624	.90
VR105	.75	1625	.75
VR150	.75	1628	.75
100TH	7.95	8001	8.95
100TS	3.00	8003	9.95
211	1.25	8005	4.95
75T	2.95	8011	3.75
250TH	14.95	8016	1.65
257B	14.95	8025A	3.95
304TH	9.95	F128A	75.00

OIL CONDENSERS:

G.E., AEROVOX, CD., ETC.

ALL RATINGS, D.C.

1mfd. 600v.	\$0.35	2mfd. 2000v.	\$1.75
2mfd. 600v.	.35	3mfd. 2000v.	2.75
4mfd. 600v.	.60	4mfd. 2000v.	3.75
8mfd. 600v.	1.10	15mfd. 2000v.	4.95
10mfd. 600v.	1.15	1mfd. 2500v.	1.25
1mfd. 1000v.	.60	25mfd. 2500v.	1.45
2mfd. 1000v.	.70	5mfd. 2500v.	1.75
4mfd. 1000v.	.95	.05mfd. 3000v.	1.95
8mfd. 1000v.	1.95	1mfd. 3000v.	2.25
10mfd. 1000v.	2.10	25mfd. 3000v.	2.65
15mfd. 1000v.	2.25	5mfd. 3000v.	2.85
20mfd. 1000v.	2.95	1mfd. 3000v.	3.50
24mfd. 1500v.	6.95	12mfd. 3000v.	6.95
25mfd. 2000v.	1.05	2mfd. 4000v.	5.95
5mfd. 2000v.	1.15	1mfd. 5000v.	4.95
1mfd. 2000v.	.95	1mfd. 7000v.	2.95

HI VOLTAGE MICAS

.01 mfd. 15000v—	\$12.95	.02 mfd. 12000v—	\$9.95
.02 mfd. 20000v—	10.95	.0005 mfd. 20000v—	9.95

CARBON PILE REGULATOR

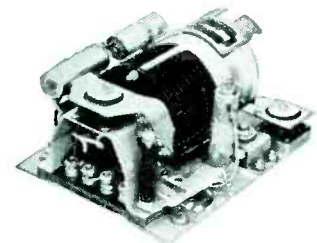

115V, 60 Cycles, 500 Watt LOAD
750 W. AIR BLAST

Uniform voltage to all equipment at any load to 500 watts. Regulates voltages to test bench and sets under test. Line voltage regulator for output of gas driven generators. Regulates line voltage from outlets in the average home. Used in rural areas where line voltage surges.
Excellent Buy at..... **\$14.95**

All merchandise guaranteed. Mail orders promptly filled.
All prices F.O.B. New York City. Send money order or check.
Shipping charges sent C.O.D. Minimum order \$5.00

RADIO HAM SHACK Inc.

63 DEY STREET • NEW YORK 7, N. Y.

ATTENTION!

INDUSTRIALS—LABS—SCHOOLS — AMATEURS

Let us quote on components and equipment that you require. We have too many items to be listed on this page. Place your name on our mailing list now for new catalog.

RELIANCE SPECIALS

PLATE TRANSFORMER—Amer. Trans. Co.—3 phase 50/60 cycle, Pri. 230V + 5% & 10%, 4.1 KVA. Sec-Taps-775 per leg. Test volts Pri 2,500 Sec 4,000.....\$50.00

HIGH VOLTAGE POWER TRANSFORMER—1 phase Westinghouse U.S.N. #CAY-30741-A, oil filled, Pri. 105-115-125V, 54 to 66 cyc; Sec. 18,000 V at 15 mils; 15,000 V at 20 mils; 2½V at 5A.....\$30.00

TRANSFORMER—Pri. 115V, 60 cyc. 1 phase. Sec. 2000 V @ 3 mils; 2.5V @ 1.75A.....\$4.95

TRANSFORMER—Pri. 115V, 60 cyc., 1 phase. Sec. 6.3V @ 60 mils, center tapped.....\$.95

SELSYN DIFFERENTIAL MOTOR—115V, 60 cy. Used as a dampener between a pair of Selsyn Transmitter Motors, or to indicate difference in degrees between a pair of Selsyns. Can be converted in 10 minutes to free running motor 3600 RPM approx. 1/70 H.P. Conversion sheet supplied. Packed for overseas.....\$1.75

SELSYN MOTORS for remote control—115V, 60 cyc.....\$6.75 pair

G.E. MOTOR—1/6 H.P. 250 V. D.C. on armature; 60 V.D.C. on field; shunt wound; 1140 R.P.M.....\$16.00

DYNAMOTORS—Input 27V @ 1.4A; output 255V @ 60 mils.....\$1.35

PRECISION RESISTOR—522,000 ohms ½% accuracy.....18c

BATHTUB CONDENSER—Aerovox .25 mfd. 400V.....9c

ALLEN HEAD SET SCREWS

2-56 x 1/16"	4-40 x 1/4"	8-32 x 1/8"
4-40 x 1/8"	6-32 x 1/8"	8-32 x 3/16"
4-40 x 3/16"	6-32 x 3/16"	8-32 x 1/4"

All sizes \$1.50 per hundred.

BALL BEARING—Fafnir—33K5—3/16" hole, 1/2" OD.....25c each

BALL BEARING—Fafnir SI KDD7—1/4" hole, 5/8" OD.....35c each

TUBE—Western Electric, 715B, 2000 V to plate, 27V filament.....\$1.95

MICRO SWITCH—Push button, normally open circuit, 45c each, 10 for.....\$4.00

CHROMALUX STRIP HEATER—115V 750 w, semi-circular 20" x 1½".....\$1.00

STEEL JUNCTION BOX—Watertight, 14 ga. steel 17" x 25" x 6½". Brass screw type hinges on lid. Weight approx. 50 lbs. \$2.75 each

FUSES—4 AG, 3 amps.....\$3.50 per 100

VEEDER COUNTER—0 to 9999.....65c

BRASS BINDING POST—Chrome plated, 8-32 screw underneath.....\$3.00 per 100

POSTAGE STAMP MICAS—.01 mfd. 300V; .002 mfd. 500V; .0012 mfd. 400V. Many other values in stock.....\$4.00 per 100

SLIP RING ASSEMBLY—5 Silver plated rings on molded bakelite rotor. Stator holds 2 silver carbon brushes for each ring. Rotor O.D. 3-7/8"; hole in rotor fits 1¼" shaft. Complete with brushes..\$2.00

RELAY—Struthers-Dunn 115V, A.C., 4 P.D.T., 6A contacts.....\$2.65

2W CARBON RESISTORS
 6,800 ohms 15,000 ohms 56,000 ohms
 10,000 ohms 33,000 ohms 68,000 ohms
 100,000 ohms

All sizes \$3.50 per hundred

F. O. B. PHILADELPHIA, PA.
 MINIMUM ORDER \$3.00

Reliance Merchandizing Co.

Arch St. Cor. Croskey

Philadelphia 3, Pa.

Telephone—RIttenhouse 6-4927

DELIVERY FROM STOCK

SERVO MOTORS: Pioneer Types CK-2, CK-5 and 10047-2A; Kollsman Type 776-01, for 400 cycles; Diehl Types FP25-3 and FPE-12 for 60 cycles.

INVERTERS: Pioneer-Bendix Types 12116, 12117 and 12123; General Electric Type 5D21NJ3A; Holtzer Cabot Types MG149, MG149F and MG149H.

SYNCHROS: (Selsyns-Autosyns, etc.) Pioneer-Bendix Types AY-1, AY-14D, AY-14G, AY-54D, AY-101D, etc.; Diehl FJE43-9 and FPE-43-1 Sine-Cosine Generators; Navy Types 1G, 1F, N, 5F, 5G, 5D, 5DG, 5CT, 6G, etc. Bureau of Ships Types M and A. General Electric Types 2J1M1, 2J5HA1, 2J5FB1, 2J1G1, 2J1M1, etc.; Kollsman Types 775-01 and 403-02, etc.

TORQUE UNITS: Pioneer-Bendix Types 12627, 12602, 12603 and 12606.

SERVO AMPLIFIERS: Pioneer Types 12073 and 12077. Custom design and fabrication of special units—give us your problem.

SERVO-TEK PRODUCTS CO.

247 Crooks Ave.

Clifton, N. J.

Call ARmory 4-2677

SURPLUS EQUIPMENT

15 TS-487/U Vacuum Tube Voltmeters Range 3-10-50 volts Peak to Peak NEW. While they last \$49.50 each

2 Pirani Gauges, Distillation Products Type PG-1A. Used, perfect condition... \$42.50 each

3 Syncroscopes, Browning Model P4E. Used, perfect Condition....\$79.50 each

250 Maguire Aircraft Transmitters, Model ART-1, 3105 KC, Xtal control, 8 watts output. NEW. Complete \$37.00 each

All prices COD
 FOB Bridgeport, Conn.

Globe Products Corporation

870 Maplewood Avenue

P. O. Box 7
 Bridgeport, Conn.

Phone 5-8774

500 WATT TRANSMITTERS

DUAL RF CHANNELS
 Remote Units

BC-447 Federal Telegraph
 CW Only \$500.00 each

BC-452 Aircraft Access. Corp.
 Phone, CW, \$950.00 each

WESTERN ENGINEERS, Ltd.
 Box 1111, Oakland, California

TELEVISION EQUIPMENT

Surplus Television cameras and transmitters from Army Guided Missile program; see I.R.E. June 1946.

Transmitters operate 260 to 320 Mc. Complete with all tubes, schematic.

Cameras have auxiliary units, all tubes including camera tube and f/1.9 lens.

An unusual opportunity for colleges, radio schools, experimental stations to obtain scarce equipment at a moderate price.

VILLAGE RADIO EQUIPMENT CO.

201 West 16th St., New York

SURPLUS COPPER CABLE WIRE

400,000 feet unused U. S. Signal Corps wire #17—four conductors 7 strands; 1320 feet per reel at \$47.50 F.O.B. Louisville, Ky. Sample sent upon request.

AMES SUPPLY CO.

3956 Pennsylvania Ave. S.E. Washington, D. C.
 TWINING — 0749

BEST QUALITY, USED ELECTRON TUBE MACHINERY

Equipment for the manufacture of all kinds of electron tubes, radio tubes, incandescent lamps, neon tubes, photo electric cells, X-ray tubes, etc.

AMERICAN ELECTRICAL SALES CO.

65-67 East 8th St. New York, N. Y.

1.5 KVA LINE TRANSFORMERS

G. E. Type TF-5, Dry
 Primary 108 to 528 volts
 Secondary 120/240 volts

\$30.00 each

WESTERN ENGINEERS, LTD.
 Box 1111, Oakland, California



SURPLUS TOWERS FOR SALE

Subject to prior sale, we offer twelve (12) new, unused War Surplus Sectionalized Antenna Towers in original unopened crates at \$175.00 each, FOB San Francisco. These towers were made by Alvey Conveyor Corp. Each Tower is packed in 4 crates, with complete assembly instructions. Steel guys with insulators included. All side pieces and cross-members heavily galvanized. Base plate and hardware included in each kit. The illustration shows this same tower in process of erection for the new KRON F-M Station of the San Francisco "Chronicle". A 33-ft. 6-bay Turnstile Antenna (not supplied) is supported by this tower.

SPECIFICATIONS

Knock-down. Height when erected 73-ft. 6-in. Triangular in shape, with base plate and one-point mounting support. Top-guyed at 3 points. Steps for climbing on one side. Weight of tower 900#. Shipping wt. 1400# crated. Will withstand wind velocity of 120-mph. Easily erected with gin-pole.

Navy 2-KW Xmtrs For Sale

● On hand for immediate sale: 3 each New, Unused Surplus TAQ-9 Transmitters. General Electric, 2-Kw. CW-MCW. 175-600 Kc. Less tubes and M-G. Dual cabinets. Will sell for the worth of the cabinets alone. Write for prices.

OFFENBACH & REIMUS CO. 372 ELLIS STREET
San Francisco 2, Calif.
Telegraph Your Order—Or Telephone ORdway 8551 (San Francisco)

Surplus Equipment

General Radio Precision Wavemeter, Type 724-A, 16 kc to 50 megacycles, 0.25% accuracy, V.T.V.M. resonance indicator, complete with accessories and carrying case, new.....\$200.00
RCA Voltmyst, VTVM, and electronic Ohmmeter, input resistance 11 megohm on ranges 3, 10, 30, 100, 300, and 1000 volts dc. A.C. Voltmeter 5 ranges 10, 30, 100, 300, 1000 volts at 1000 ohms per volt. Ohmmeter covers 0.1 ohm to 1000 megohms in 6 ranges. Operates on 115 volts 60 cps. New \$50.00
RCA Beat Frequency Audio Signal Generator, 30—15000 cps, portable, 115 volts 60 cps, output impedance 250, 500, and 5000 ohms new...\$60.00
RCA 5" Cathode Ray Scope, model 160B, new.....\$135.00
General Radio Signal Generator, model 804B, 7.5 to 330 megacycles, 1 to 20,000 microvolts metered output, metered modulation, used but in good working order.....\$275.00
Synchroscope, model P-4, used, in good working order.....\$200.00
Measurements Signal Generator, model 78B, 15-25 and 150-230 megacycles, metered output, inductive attenuator, 1 to 100,000 microvolts, 400 and 8200 cps modulation, new.....\$90.00
Transtat, Amertran type TH 2½B, .6 kw, 115 to 220 volts 60 cps, new \$18.00
Voltage Regulator Transtat, Amertran, 11.5 kva, 115 volts 60 cps, 2 gang, new.....\$125.00
Transformers, 115 volts 60 cps primaries:

1. 7500 volts 35 ma, ungrounded, Thordarsen.....\$15.00
 2. 6250 volts 80 ma, ungrounded, G. E.\$12.00
 3. 6250, 3250, and 2000 volts, tapped primary.....\$14.00
 4. 2 secondaries at 500 volts 5 amps each, wt 210 pounds.....\$50.00
- Pulse Input Transformer, permalloy core, 50 to 4000 kc, impedance ratio 120 to 2350 ohms, W. E. D161310 \$2.80
Pulse Transformer, Westinghouse 145-EWP.....\$2.50
High Voltage Switch, motor driven, 18000 v peak at 5 amps, DP-ST. \$15.00
High Voltage Relay, 25000 volts 35 amps, 60 cps, DP-DT, 2200 volt 60 cps, Coil.....\$50.00
Ceramic Feed Thru Capacitors, threaded, 50 mmfd, 1000 volts...15¢
SD-3 Radar Equipment, complete with all accessories, operates on 115 Volts, 60 cps, new
SA-2 Radar equipment less antenna, good working order, 115 Volts, 60 cps
BC 947-A Radar Transmitters less power supplies (10 cm).....\$30.00
Microwave equipment, 3 cm, and 10 cm, variety but small quantities wave guide sections, fittings, connectors, couplers, magnetrons klystrons, magnets, pulse transformers, etc. Prompt quotation on specific items.

Electro Impulse Laboratory

Box 250 Red Bank, N. J.
Red Bank 6-4247

100 AMERTRAN 11.5 KVA TRANSTATS Continuously variable 0-115 volts — 100 amps

Four 115v coils, separate brushes which may be connected for 230v 50 amp single phase, 3 phase open delta, etc.

NEW IN ORIGINAL CRATES

\$50.00 each

WESTERN ENGINEERS, Ltd.
Box 1111, Oakland, California

DIRECTION FINDERS

New Federal DAK-3 units 110 V 60 cycle complete export packed 7 cartons: 250 to 1500 kc \$350 each, \$275 quantity.

VILLAGE RADIO EQUIPMENT
201 West 16 Street New York City

MOTOR SPECIAL

Delco 5069466 27.5 volt DC motor, 10,000 rpm governor controlled.

Price \$3.75 each net

Quantity prices on request

SERVO TEK PRODUCTS CO.
247 Crooks Ave. Clifton, N. J.

"TIK" for KITS

**Servicemen — Amateurs —
Jobbers
Look at these Values**

Mica Condensers Assorted....100 for \$3.49
Allen Bradley, etc., Volume Controls 50 ohm, to 1 meg.....12 for \$2.59
Carbon Resistors, Color Coded, ½, 1 & 2 Watt.....100 for \$2.50
Wire Wound Resistors, Ward Leonard etc. 5 to 75 Watt.....20 for \$2.98
Fuses, Buss & Littlefuse.....100 for \$1.89
Assorted Oil filled condensers, tubular and bath tub type, 400 V, 600 V, 1000 Volts.....12 for \$2.49
Octal and 4 prong Ceramic Sockets (without rings).....100 for \$3.98
Condensors .05 mfd, 2,000 volt to .25 mfd 3,000 WVDC.....6 for \$3.59
Precision Wire Wound Resistors, Shallcross, Mepco, etc., ¼, ½ and 1 Watt 12 for \$3.98

SPECIAL COMBO KIT OUR INTRODUCTORY OFFER

Excellent Assortment—Big Value—Tremendous Savings. This kit includes a quantity of items listed in the above kits, PLUS \$10.98 many others. It's our New Customers special

Minimum order \$2.00
25% deposit required on all C.O.D. orders.
Add postage Write Dept. ELS

"TIK" 55 WALKER ST.,
NEW YORK 13, N. Y.
phone CAnal 6-7485



K-TRAN

IMITATED...NOT DUPLICATED

The K-TRAN is not the first or the best miniature i.f. Transformer.

The K-TRAN is not a miniature i.f. Transformer at all.

The K-TRAN is the best i.f. Transformer available regardless of size.

Almost every major set manufacturer now has designed K-TRANS into one or more models.

Keep ahead of competition by using K-TRANS in all your new designs.

ECONOMICAL—K-TRANS cost less to purchase—less to use.

EFFICIENT—K-TRANS will duplicate or exceed the performance of your present i.f. Transformers.

STABLE—Permeability tuning, magnetic shielding of windings, silver mica condensers combine to give a stability never before obtainable in a standard commercial i.f. Transformer.

VERSATILE—Recent additions to the K-TRAN line provide a K-TRAN for every price or performance need.

Design your chassis to
use  262 KC,
455 KC, 10.7 MC

AUTOMATIC
MANUFACTURING
CORPORATION

MASS PRODUCTION COILS & MICA TRIMMER CONDENSERS

900 PASSAIC AVE.

EAST NEWARK, N. J.

INDEX TO ADVERTISERS

Acheson Colloids Corporation	11	Dumont Electric Corp.	6
Acme Electric Corp.	170	Dumont Laboratories, Inc.	
Aero Electric Co.	190	Allen B.	30, 31
Allen Co., Inc., L. B.	269		
Allen Mfg. Co.	243		
Allen-Bradley Co.	34		
Alliance Manufacturing Co.	70		
Allied Control Co.	28		
Altec Lansing Corporation	159		
American Brass Co., Waterbury Brass Goods Branch	204		
American Lava Corporation	161		
American Phenolic Corp.	198		
American Relay & Controls, Inc.	166		
American Screw Company	38		
American Smelting & Refining Co.	37		
American Television & Radio Co.	230		
American Time Products, Inc.	215		
Amperex Electronic Corporation	9		
Amperite Company	253		
Anaconda Wire and Cable Co.	169		
Ansonia Electrical Div. of Noma Electric Corp.	60		
Arnold Engineering Co.	231		
Art Wire & Stamping Co.	261		
Art-Lloyd Metal Products Corp.	234		
Astafle Corporation	200		
Atlas Sound Corp.	246		
Audak Company	32A		
Audio Devices, Inc.	33		
Automatic Mfg. Corporation	282		
Avimo, Ltd.	238		

Baer Co., N. S.	232
Ballantine Laboratories, Inc.	152
Beaver Gear Works, Inc.	77
Bell Telephone Laboratories	203
Bentley, Harris Mfg. Co.	64
Boonton Radio Corporation	137
Bradley Laboratories, Inc.	226, 240
Brady Co., W. H.	240
Brand & Co., Wm.	153
Brook Electronics, Inc.	250
Browning Labs, Inc.	248
Brush Development Co.	158, 210
Buck Engineering Co., Inc.	269
Bud Radio, Inc.	283
Burlington Instrument Co.	245

Callite Tungsten Corporation	42
Cambridge Thermionic Corp.	262
Cannon Electric Development Co.	172
Capitol Radio Engineering Institute	258
Cellusuede Products, Inc.	233
Central Paper Co., Inc.	264
Centralab, Div. of Globe-Union Inc.	14, 15, 25
Chicago Transformer, Div. of Essex Wire Corp.	165
Cinch Manufacturing Corporation	129
Clare & Co., C. P.	63
Clarostat Mfg. Co., Inc.	246
Cleveland Container Co.	227
Clippard Instrument Laboratory, Inc.	269
Clough Brengle Co.	265
Cohn & Co., Sigmund	242
Collins Audio Products Co., Inc.	255
Collins Radio Co.	35
Concord Radio Corporation	249
Condenser Products Co.	225
Consolidated Molded Products Corp.	56
Continental Electric Co.	243
Cornell-Dubiller Electric Corp.	183
Cornish Wire Company, Inc.	214
Cramer Co., R. W.	242
Croname, Inc.	199
Cross Co., H.	269
Cyclotron Specialties Co.	75

Inside	
Daven Co.	Back Cover
Dial Light Co. of America	259
Dinion Coll Co., Inc.	260
Dow Corning Corporation	262
Driver-Harris Company	71

Eastern Air Devices, Inc.	66
Eastern Industries, Inc.	249
Eisler Engineering Co., Inc.	249, 260
Eitel-McCullough, Inc.	65
Electran Mfg. Co.	234
Electric Indicator Co.	251
Electrical Insulation Co., Inc.	243
Electro Engineering Works	269
Electro Motive Mfg. Co.	43
Electro Products Labs	236
Electrons, Inc.	212
Erie Resistor Corporation	175
Essex Electronics	284
Essex Wire Corp.	219

Fairchild Camera and Instrument Corp.	12, 244
Federal Tel. & Radio Corp.	23, 185
Fenwal, Inc.	187
Franklin Mfg. Corp., A. W.	179
Furst Electronics	256

Garrett Co., Inc., George K.	143
General Cement Mfg. Co.	269
General Chemical Co.	47
General Control Co.	217
General Electric Co.	
Apparatus Dept.	44, 45, 58
Appliance and Merchandise Dept.	32
Chemical Dept.	171, 209
Electronics Department	17, 68, 69, 237
General Industries Co.	162
General Magnetic Corporation	240
General Plate Div. of Metals & Controls Corp.	195
General Radio Co.	211
Goodrich Co., B. F.	263
Goodrich Electric and Mfg. Co.	257
Graphite Metallizing Corp.	234
Graybar Electric Co.	220
Guardian Electric Mfg. Co.	73

Hammarlund Mfg. Co., Inc.	8, 251, 259
Handy & Harman	256
Hart Manufacturing Co.	154
Harvey Radio Company, Inc.	222
Harvey Radio Laboratories, Inc.	141
Hathaway Instrument Co.	247
Haydon Manufacturing Co., Inc.	188
Hunt Corp.	13
Hunt Corp.	192
Hunter Pressed Steel Co.	41
Hytron Radio & Electronics Corp.	32

Imperial Tracing Cloth	222
Indiana Steel Products Co.	32D
Insl-X Company, Inc.	182
Insulation Manufacturers Corp.	133
International Machine Works	253
International Resistance Co.	139

J. F. D. Mfg. Co.	251
Jelliff Mfg. Corp., C. O.	252
Jensen Manufacturing Co.	59
Johnson Co., E. F., Gothard Div.	232
Jones Div., Howard B., Cinch Mfg. Co.	247

Kable Engineering Co.	269
Karp Metal Products Co., Inc.	29



FREQUENCY CALIBRATOR

CAT. NO. FCC-90



Measures only 2 1/4" by 4 1/4"

• Now you never have to take the chance of getting a pink ticket for off-frequency operation . . . BUD makes it easy for you to know your exact frequency. The new BUD Frequency Calibrator is easy to use, is entirely self-powered and has these exclusive features:

It is not necessary to open up or take apart your receiver to wire-in this unit . . . just plug in to 110 volt line and connect output lead to antenna post of your receiver.

Has 100 kilocycle crystal, rich in harmonics.

Has compensating condenser to zero beat WWV.

Has usable harmonics up to 30 megacycles.

Has ON-OFF switch, and STANDBY switch.

Complete with tube and crystal \$14.25
... Dealer net only

See it at your distributor's today.
Install one in your RIG TONIGHT!

BUD CAN SUPPLY ALL YOUR NEEDS!

. . . with the latest types of equipment including: condensers—chokes—coils—insulators—plugs—jacks—switches—dials—test leads—jewel lights and a complete line of ultra-modern cabinets and chassis.



FOR PRODUCT INFORMATION
Refer to the 1947-48 Issue of
ELECTRONICS BUYERS' GUIDE



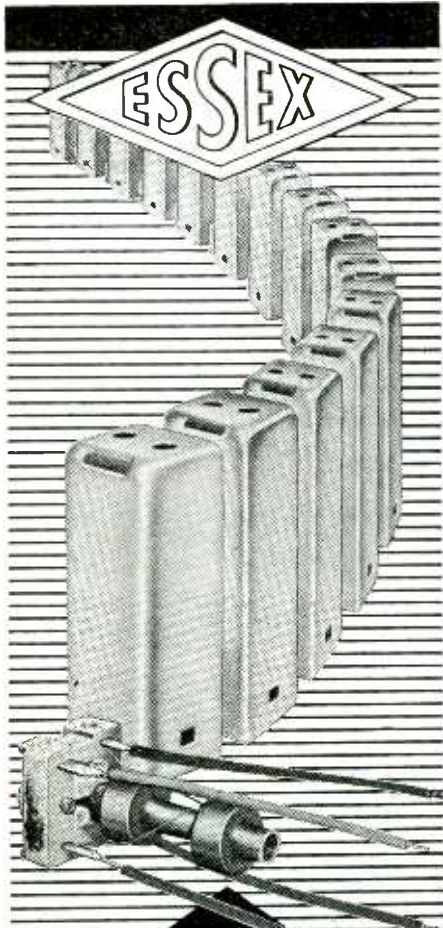

ESSEX

**MIDGET
I.F.
TRANSFORMERS**

**for all types of
RADIOS**

Performance equivalent
to larger I.F.'s.

3/4" x 3/4" x 2" high

We are in full production on
this item. When inquiring,
please designate type of
radio considered.

Orders accepted for
PROMPT DELIVERY

Precision manufacturers of all
types of IF and RF coils,
chokes, and transformers.

**ESSEX
ELECTRONICS**
Berkeley Heights, New Jersey

Kay Electric Co.	229	Sperry Gyroscope Co., Inc.	67
Kenyon Transformer Co., Inc.	36	Sprague Electric Co.	72
Kester Solder Co.	186	Stackpole Carbon Company	149
Keuffel & Esser Co.	3	Stamford Metal Specialty Co.	255
Kinney Mfg. Co.	164	Standard Pressed Steel Co.	157
Knights Co., James	257	Standard Telephones and Cables, Ltd.	32B
Lampkin Laboratories	269	Star Expansion Products Co., Inc.	253
Langevin Co.	19	Stevens-Waldea, Inc.	230
Lapp Insulator Co., Inc.	53	Steward Mfg. Co., D. M.	261
Lavoie Laboratories	145	Stewart Mfg. Corp., F. W.	249
Leach Relay Co.	238	Struthers-Dunn, Inc.	2
Legri S Company, Inc.	240	Superior Electric Co.	207
Linde Air Products, Co.	253, 255	Superior Tube Company	163
Littelfuse, Inc.	250	Sylvania Electric Products Inc., Electronics Div.	173
Lord Manufacturing Co.	27	Tech Laboratories, Inc.	263
Maguire Industries, Inc.	39	Technical Products International	259
Makepeace Co., D. E.	40	Technology Instrument Corp.	239
Mallory & Co., Inc., P. R.	78, 131	Telex, Inc.	184
McGraw-Hill Book Co.	240, 245	Triplet Electrical Instrument Co.	221
Measurements Corporation	174	Turner Co.	176
Miles Reproducer Co., Inc.	269	Union Carbide and Carbon Corp. 253, 255 Inside	
Milford Rivet & Machine Co.	265	United Transformer Corp. ... Front Cover	
Millen Mfg. Co., Inc., James	218	Universal Microphone Co.	257
Miniature Precision Bearings	269	University Loudspeakers, Inc.	218
Minnesota Mining and Mfg. Co.	61, 167	Variflex Corporation	177
Mitchell-Rand Insulation Co., Inc.	18	Victoreen Instrument Co.	178
Multi-Products Tool Co.	255	Vitamite Company	233
Multicore Solders, Ltd.	181	War Assets Administration	223
Myalex Corporation of America	247	Ward Leonard Electric Co.	48, 49
National Company, Inc.	197	Ward Products Corp.	224
New Wrinkle, Inc.	156	Webster Electric Co.	206
North American Phillips Co., Inc.	213	Weller Mfg. Co.	247
Nothelfer Winding Laboratories	256	Western Electric Co.	4, 5, 57 135, 220
O'Neill-Irwin Mfg. Co.	224	Westinghouse Electric Corp.	55
Olympic Tool & Mfg. Co., Inc.	236	Weston Electrical Instrument Corp.	62
Palmut Co.	233	Whistler & Sons, Inc., S. B.	7
Panoramic Radio Corp.	252	White Dental Mfg. Co., S. S.	180, 261
Paper Machinery and Research, Inc.	261	Whitehead Stamping Co.	257
Paramount Paper Tube Corp.	220	Wilson Co., H. A.	205
Park Metalware Co., Inc.	259		
Paul & Beekman, Inc., Sub. of Portable Products Corp.	148		
Photovolt Corp.	261		
Plastic Wire and Cable Corp.	20, 21		
Plastold Corp.	248		
Plax Corp.	51		
Polarad Electronics Co.	254		
Potter Instrument Co.	26		
Potter & Brumfield Sales Co.	10		
Precision Apparatus Co., Inc.	258		
Precision Tube Co.	194		
Premier Metal Etching Company	264		
Presto Recording Corp.	46		
Progressive Mfg. Co.	251		
Pyroferrie Co.	244		
Quadrige Manufacturing Co.	259		
Quaker City Gear Works, Inc.	160		
Racon Electric Co., Inc.	241		
Radio Corp. of America	Back Cover		
Radio Engineering Labs, Inc.	147		
Radio-Music Corp.	216		
Radio Receptor Co., Inc.	228		
Railway Express Agency, Air Express Div.	208		
Rauland Corp.	260		
Raytheon Mfg. Co.	168		
Reeves-Hoffman Corp.	245		
Reeves Soundcraft Corp.	196		
Revere Copper & Brass, Inc.	22		
Richardson Company	32C		
Rockbestos Products Corp.	193		
Russell Electric Co.	155		
Sangamo Electric Co.	16		
Schweitzer Paper Co., Inc.	201		
Scientific Electric Div. of "S" Corrugated Quenched Gap, Co.	226		
Scintilla Magneto Div., Bendix Aviation Corp.	202		
Scovill Mfg. Co.	150		
Selenium Corp. of America	151		
Shakeproof, Inc.	16A, 16B		
Shalleross Mfg. Co.	76		
Shaw Insulator Co.	50		
Sigma Instruments, Inc.	228		
Signal Engineering & Mfg. Co.	257		
Sillcocks-Miller Co.	238		
Simpson Electric Co.	189		
Smith Laboratories, Melvin L.	236		
Solar Manufacturing Corporation.	24, 74		
Sorensen and Co., Inc.	235		
Speer Carbon Co.	54		

PROFESSIONAL SERVICES 270

**SEARCHLIGHT SECTION
(Classified Advertising)**

EMPLOYMENT	
Positions Vacant	270, 271
Positions Wanted	271
Selling Opp. Wanted	271, 272
Employment Services	271
BUSINESS OPPORTUNITIES	
Offered	272
EQUIPMENT	
(Used or Surplus New)	
For Sale	272-281
Wanted	272
ADVERTISERS INDEX	
American Electric Sales Co., Inc.	280
Ames Supply Co.	280
Brooks Inc., B. D.	278
Clark-Reiss Distributors.	272
Communications Equipment Co.	271
Electro Impulse Laboratory.	79
Electronicraft Inc.	278
Electro-Tech Equipment Co.	277
Finch Telecommunications, Inc.	272
Fink & Olswang	272
Globe Products Corp.	280
Hirsch Co., J. M.	272
Mallory & Co., Inc., P. R.	272
Maritime Switchboard	273
Maspeith Telephone & Radio Corp.	278
Microwave Equipment Co.	272
Niagara Radio Supply	276
Offenbach & Reimus Co.	281
Precision Electrical Instrument Co.	278
Radio Ham Shack, Inc.	279
Reliance Merchandising Co.	280
Servo-Tek Products Co.	272, 278, 280, 281
Tab	275
Tik	281
U. S. Plastics Corporation.	272
Village Radio Equipment.	272, 278, 280, 281
Western Engineers, Ltd.	272, 278, 280, 281

DAVEN

ENGINEERING LEADERSHIP

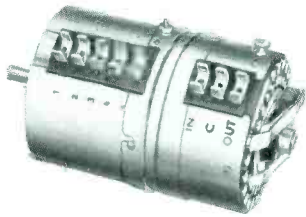

tone compensating attenuator TYPE LAC-720

... frequency characteristics follow the hearing response curves of the human ear. Base frequencies have smaller loss than the middle or upper registers. (Pat. Pend.)

Here are 4 of the more recent DAVEN "firsts". DAVEN long has been known for leadership . . . particularly in engineering and design. Many of our developments have been incorporated in the equipment of broadcasting stations, sound recording studios, and electrical laboratories throughout the world, and are specified as standard.

The DAVEN Engineering Department will be glad to discuss these new developments with you. Your inquiry is invited on the units shown or on any other DAVEN product.

THE **DAVEN** CO.

191 CENTRAL AVENUE
NEWARK 4, NEW JERSEY

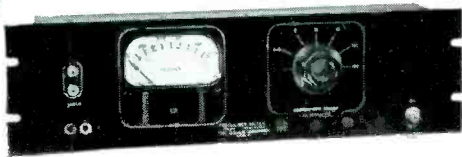

FREQUENCY METER TYPE 838

... frequencies read directly to 100,000 cycles with an accuracy of $\pm 2\%$ of full scale in use . . . 7 ranges available . . . low input voltage requirements . . . large, easy-to-read illuminated meter . . . mounted on a 5 1/4" relay rack panel.



TRANSMISSION TEST SET TYPE 8A

... a portable, 12-pound battery operated set . . . receiving amplifier measures levels down to -50 DBM . . . contains an internal 1000 cycle oscillator . . . can also serve as a bridging V.U. indicator with range of -40 to $+23$ V.U.

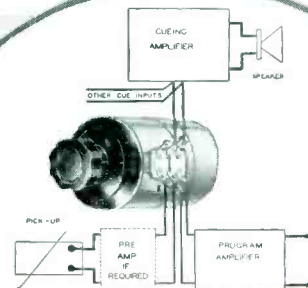

ATTENUATORS WITH BUILT-IN CUEING CONTROLS

... eliminate the need for auxiliary switching mechanisms . . . also available with built-in switchette for a pilot light . . . may be obtained on Ladder, "T", Potentiometer, and Ladder Fader controls. (Pat. Pend.)

RCA QUICK-REFERENCE CHART MINIATURE TUBES



RCA Miniatures make practical, compact, lightweight designs. Often, they provide superior performance at less cost.

Type No.	Class	Performance Equivalent	Applications
OA2	Voltage Regulator	OD3/VR150	Cold-Cathode Glow-Discharge Type.
1A3	H-F Diode	—	Heater-Cathode type. Discriminator for battery-operated FM receivers; portable h-f measuring equipment. Resonant frequency about 1000 Mc.
1L4	R-F Amplifier Pentode	1U4	Filamentary type. Sharp cutoff characteristic. For battery-operated portables.
1R5	Pentagrid Converter	—	Filamentary type. Mixer tube and oscillator in superheterodyne circuits. For portable receivers.
1S4	Power Amplifier Pentode	3S4	Filamentary type. For battery receivers.
1S5	Diode-Pentode	—	Filamentary type. High voltage gain. For broadcast receivers.
1T4	Super-Control R-F Amplifier Pentode	—	R-F or i-f amplifier in battery-operated receivers.
1U4	R-F Amplifier Pentode	1N5-GT	Sharp cutoff characteristic. For low-drain battery-operated receivers.
2D21	Thyratron Tetrode	2050	Relay tube and grid-controlled rectifier. Will operate directly from high-vacuum phototube.
3A4	Power Amplifier Pentode	—	Filamentary type. A-F output of 700 milliwatts, or r-f output of 1.2 watts at 10 Mc.
3A5	H-F Twin Triode	—	Filamentary type. For use in h-f applications. Class C output about 2 watts at 40 Mc.
3Q4	Power Amplifier Pentode	3Q5-GT	Filamentary type. For 3-way battery portable receivers.
3S4	Power Amplifier Pentode	1S4	Filamentary type. For battery portable equipment.
3V4	Power Amplifier Pentode	3Q4	Filamentary type. Similar to 3Q4, but has preferable basing arrangement. For 3-way battery portable receivers.
6AG5	R-F Amplifier Pentode	—	Sharp cutoff characteristic. High transconductance and low input and output capacitance. I-F video amplifier or r-f amplifier up to 400 Mc.
6AK5	R-F Amplifier Pentode	—	Sharp cutoff characteristic. High transconductance, low input and output capacitance, and low input conductance at high frequencies.
6AK6	Power Amplifier Pentode	6G6-G	Singly or in push-pull in output stage. A-F power output 1.1 watts per tube.
6AL5	H-F Twin Diode	—	High permeance makes it particularly useful as an F-M detector.
6AQ5	Beam Power Amplifier	5V6	For automobile and ac-operated receivers.
6AQ6	Duplex-Diode High-Mu Triode	6S27	Combined detector, a-f amplifier, and avc tube.
6AT6	Duplex-Diode High-Mu Triode	6SQ7	Combined detector, amplifier, and avc tube.
6AU6	R-F Amplifier Pentode	6SH7	Sharp cutoff characteristic. High transconductance and low grid-plate capacitance. Limiter for FM receivers.
6BA6	R-F Amplifier Pentode	6SG7	Remote cutoff characteristic. High transconductance and low grid-plate capacitance. For r-f and i-f stages of FM and AM receivers.
6BE6	Pentagrid Converter	6SA7	Mixer tube and oscillator in superheterodyne circuits. For FM and AM receivers.

Type No.	Class	Performance Equivalent	Applications
6BF6	Duplex-Diode Triode	6SR7	For use as a combined detector, amplifier, and avc tube. For auto and ac-operated receivers.
6C4	V-H-F Power Triode	—	Class C amplifier and oscillator. Class C output about 5.5 watts at moderate frequencies, 2.5 watts at 150 Mc.
6J4	U-H-F Amplifier Triode	—	Primarily for use as grounded-grid amplifier up to 500 Mc. Transconductance 12000 micromhos, mu 55, low capacitances.
6J6	Twin Triode	—	Particularly useful as mixer or oscillator up to 600 Mc.
6X4	Full-Wave Rectifier	6X5	High-vacuum type. For use in auto and ac-operated receivers.
12AT6	Duplex-Diode High-Mu Triode	12SQ7	For use in compact ac/dc receivers.
12AU6	R-F Amplifier Pentode	12SH7	Sharp cutoff characteristic. Limiter tube for ac/dc FM receivers.
12AU7	Twin Triode Amplifier	12SN7-GT	Separate terminals for each cathode, and mid-tapped heater for 6.3- or 12.6-volt operation. Mixer oscillator, multivibrator.
12AW6	R-F Amplifier Pentode	6AG5	Sharp cutoff characteristic. R-F amplifier for ac/dc FM receivers.
12BA6	R-F Amplifier Pentode	12SG7	Remote cutoff characteristic. For use in compact ac/dc receivers.
12BE6	Pentagrid Converter	12SA7	For use in compact ac/dc receivers.
26A6	R-F Amplifier Pentode	12BA6	Remote cutoff characteristic. Features high transconductance. For 12-cell storage-battery operation.
26C6	Duplex-Diode Triode	12AT6	Combined detector, amplifier, and avc tube. For 12-cell storage-battery operation.
26D6	Pentagrid Converter	12BE6	Mixer tube and oscillator. For 12-cell storage-battery operation.
35B5	Beam Power Amplifier	35L6-GT	High power sensitivity and high efficiency for use in output stages of ac/dc receivers.
35W4	Half-Wave Rectifier	35Z5-GT	High-vacuum type. Heater tap for panel lamp. For use in compact ac/dc receivers.
45Z3	Half-Wave Rectifier	—	High-vacuum type. Heater rating, 0.075 ampere at 45 volts. For 3-way battery portable receivers.
50B5	Beam-Power Amplifier	50L6-GT	For output use in ac/dc receivers. Maximum-signal power output, 1.9 watts.
117Z3	Half-Wave Rectifier	—	High-vacuum type. For supplying rectified power to 3-way battery portable equipment.
1654	Half-Wave Rectifier	—	High-vacuum, filamentary type. Maximum peak inverse rating 7000 volts, filament current 0.05 ampere.
9001	Sharp Cutoff U-H-F Pentode	—	R-F amplifier or detector in U-H-F service.
9002	U-H-F Triode	—	U-H-F detector and amplifier. May be used as oscillator in superheterodyne receivers at frequencies up to 500 Mc.
9003	Remote Cutoff U-H-F Pentode	—	Useful as a mixer or as an r-f or i-f amplifier in U-H-F service.
9006	U-H-F Diode	—	or U-H-F service as rectifier, detector, or measuring device. Resonant frequency, about 700 Mc.

For additional technical data on these types, refer to the RCA HB-3 Handbook, or write RCA, Commercial Engineering, Section R-401, Harrison, N. J.

THE FOUNTAINHEAD OF MODERN TUBE DEVELOPMENT IS RCA



TUBE DEPARTMENT

RADIO CORPORATION of AMERICA

HARRISON, N. J.